





 **Genie Lite³**

XC HARNESS

CONTENTS

Genie Lite³

Thank You.....	4
Warning.....	5
Introducing Genie lite ³	6
Specifications.....	7
Components of The Genie lite ³	8
Before You Fly.....	9
Rescue.....	10
Installation.....	14
Storage.....	20
Adjustments.....	21
Flying with the Genie Lite ³	24
Maintenanance and Repairs.....	27
Final Words.....	30
Harness Diagram.....	34

THANK YOU

For choosing Gin Gliders. We are confident you'll enjoy many rewarding experiences in the air with your new GIN harness.

This manual contains important safety, performance and maintenance information. Read it before your first flight, keep it for reference, and please pass it on to the new owner if you ever re-sell your harness.

Any updates to this manual, or relevant safety information, will be published on our website: www.gingliders.com. You can also register for e-mail updates via our website.

Happy flying and safe landings,
GIN Team



WARNING

Like any extreme sport, paragliding involves unpredictable risks which may lead to injury or death. By choosing to fly, you assume the sole responsibility for those risks. You can minimize the risks by having the appropriate attitude, training and experience and by properly understanding, using and maintaining your equipment. Always seek to expand your knowledge and to develop self-reliance. If there is anything you do not understand, consult with your local dealer as a first point of contact, with the GIN importer in your country or with Gin Gliders directly.

Because it is impossible to anticipate every situation or condition that can occur while paragliding, this manual makes no representation about the safe use of the paragliding equipment under all conditions. Neither Gin Gliders nor the seller of GIN equipment can guarantee, or be held responsible for, the safety of yourself or anyone else.

Many countries have specific regulations or laws regarding paragliding activity. It's your responsibility to know and observe the regulations of the region where you fly.

INTENDED USE: *Lightweight air sports equipment with a maximum mass of less than 120kg, operated in the paragliding division.*

INTRODUCING THE **GENIE LITE³**

The Genie Lite 3 is for sport and XC pilots who are looking for a light cocoon harness with all the essential features and no compromises in comfort. It is intended only for the use as a harness for an EN certified paraglider and not for any other use.

COMFORTABLE AND AERODYNAMIC

Drawing on our technology from the Genie Race 4, the Genie Lite 3 has been designed for maximum XC comfort. The back of the harness is robust, with support that contours to the back in all the right places thanks to the 3D shaping. With the inclusion of the revolutionary new back protection from Neo / Koroyd, the harness has a much smaller cross sectional area and less drag. The new fairing helps make the Genie Lite 3 the best performing harness we have ever made in this class.

STABLE GEOMETRY

The Genie Lite 3 is reassuring in turbulence as a result of careful optimization of the height of the carabiner attachment points and the overall harness geometry. Piloting and feedback is precise and informative, thanks to the triplex seat board.



SPECIFICATIONS

Size	XS	S	M	L
Harness weight (kg)*	~4.3kg	4.4	4.8	5.0
Pilot height (cm)	<165	160-175	170-185	185-200
Rescue volume (l)	5.2	5.5	5.5	5.8
Carabiner distance (cm)	34-43	34-43	36-46	40-49
Seat plate width (cm)	27	27	28	30
Seat plate height (cm)	31	31	33	35
Cockpit volume (L)	4	4	4.5	4.5
Under seat pocket volume (L)	3.5	3.5	4.2	4.8

CERTIFICATION

The Genie Lite³ is **EN** and **LTF** certified, max load 120 daN
 Certification number: **PH 277.2019** | **CE** certification

DELIVERY PACKAGE

- 1 Harness
- 1 Triplex seat plate and foot plate
- 1 Flight deck (integrated into cocoon)
- 1 Rescue deployment handle
- 1 Rescue bridle
- 2 GIN 30mm carabiners

BACK PROTECTION

KOROYD 9cm Back protection
 CE and EN Certified



COMPONENTS OF THE GENIE LITE³

1 BACK PROTECTION

The Genie Lite comes with the Neo Koroyd back protector. The protection must be inspected after any impact and assessed for damage. A damaged back protection must be replaced before the next use. The protection protects the pilot as much as possible in the event of an incident, but it cannot completely eliminate the risk of injury. The Genie Lite³ back protection is EN and CE certified.

<https://koroyd.com/>

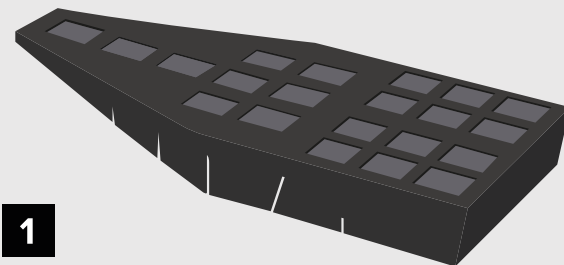

2 TRIPLEX SEAT AND FOOT PLATE

Included with your harness is a triplex seat plate and a triplex foot plate. Both are durable and strong while providing you with a much lighter alternative to wood.

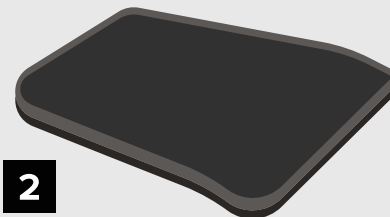

3 GIN CARABINERS

Included with your harness is a pair of GIN 30mm carabiners. The Genie Lite³ is not compatible with quick release carabiners.



4 FLIGHT DECK

Included with the Genie Lite³ harness is a custom designed flight deck, with integrated hook knife. The flight deck is designed to seamlessly connect with the cocoon, providing you with room for a GPS and vario or other flying instruments. The flight deck also has a 4.5L pocket (M size) to be used for storing easy access items in flight or as a ballast.

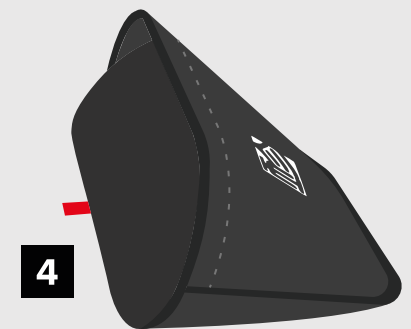

BEFORE YOU FLY

Make sure your dealer has checked the harness for completeness and basic settings. Your harness must be assembled by a suitably qualified paragliding professional, for example, your instructor.

GIN Gliders recommends that assembly be carried out in the following order. If you are in any doubt whatsoever about this procedure, please seek professional advice from your instructor, GIN dealer or importer.

INSTALLING THE SPEED SYSTEM

Assemble the speed system from top to bottom. Pass the cord along the inside of the harness and route it through the pulley (1). From the pulley, route the cord through the metal ring at the bottom edge of the seat (2). Connect the cord to the speedbar using a secure knot (3). Finish by attaching the speedbars elastic cord to the foot plate of the cocoon. If flying without cocoon' remove elastic chord from the speedbar.

Hanging in the simulator, adjust the length of the speed bar cord so that the bar hangs at least 15cm below the front of the harness. Making the cord too short could result in the speed system being constantly or unintentionally engaged during flight. It is safer to start with the speed bar a little long and shorten it following your first flights. Test the speed bar in flight only after you are comfortable with your new harness, and always do so in calm conditions with enough clearance above the ground.

 See page 22 for speed system adjustment

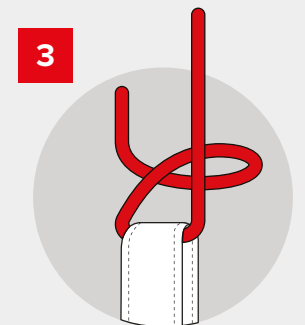
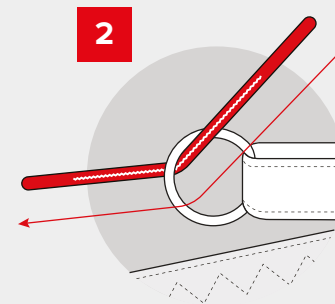
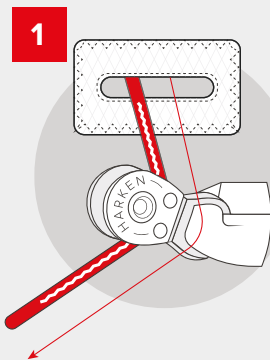
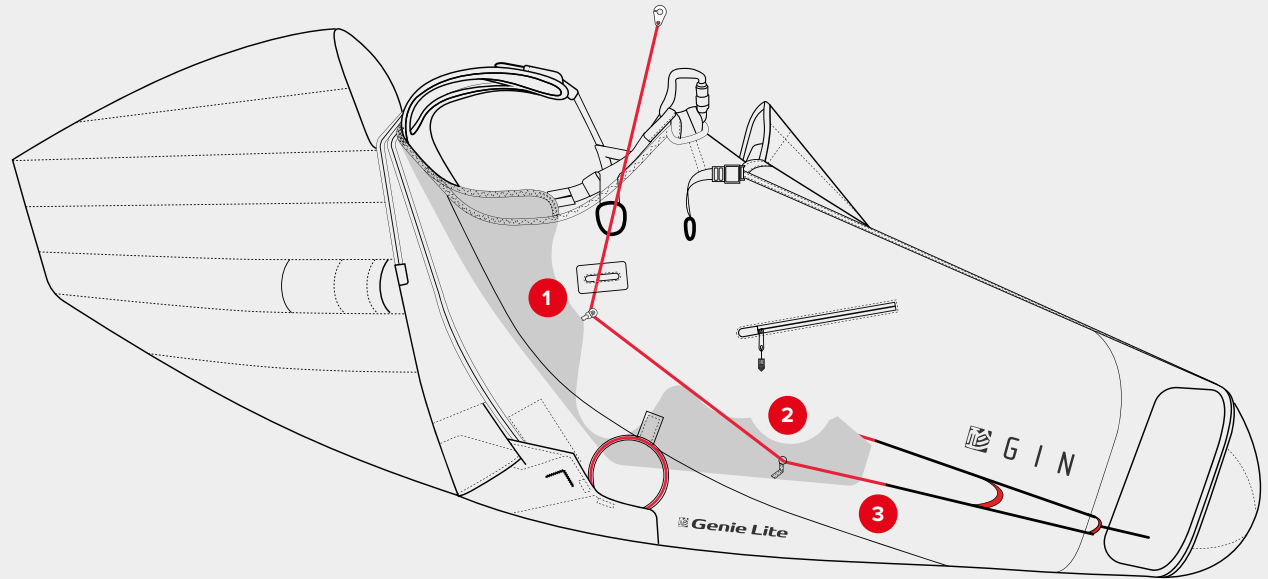

! CAUTION: Make sure that the speed system is not too short. The front risers of your paraglider must not be pulled down in normal (unaccelerated) flight.

INSTALLING THE SEAT PLATE

The seat plate is removable and can be accessed by a panel at the front edge of the seat. The seat plate should be installed with the round corners orientated to the rear of the harness and the square corners at the front. After installation be sure to close the velcro flap properly.

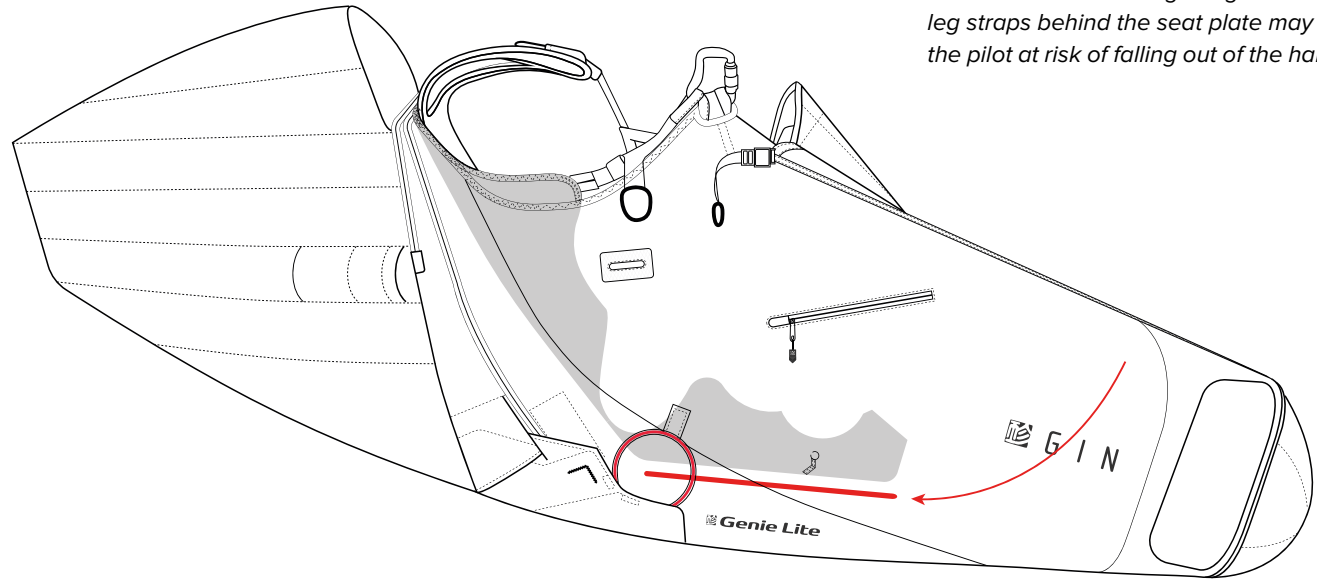

WARNING: Forgetting to loop the leg straps behind the seat plate may place the pilot at risk of falling out of the harness.

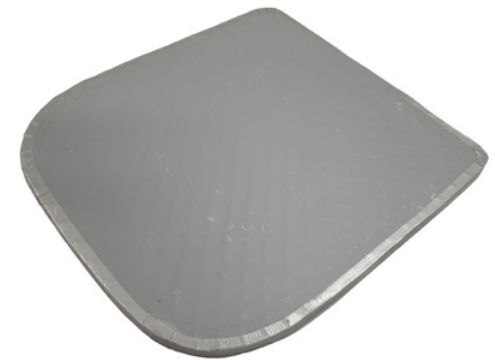

INSTALLING THE BACK PROTECTOR

To install the back protector in the Genie Lite 3, first open the zipper compartment under the seat. Insert the back protector with the narrow end first. Help guide the back protector into the proper position making sure that the narrow top piece properly sits between the back support and the rescue container. The back protector should fit snugly into the container. Once you are sure the protector is installed correctly, close the protector compartment zipper.

MAINTAINING THE BACK PROTECTOR

We recommend that you inspect your back protection periodically in case it was damaged by rough handling at the take-off/landing or transportation (e.g. Airport handlers).

We recommend that you do not fly with a back protector that shows signs of damage.

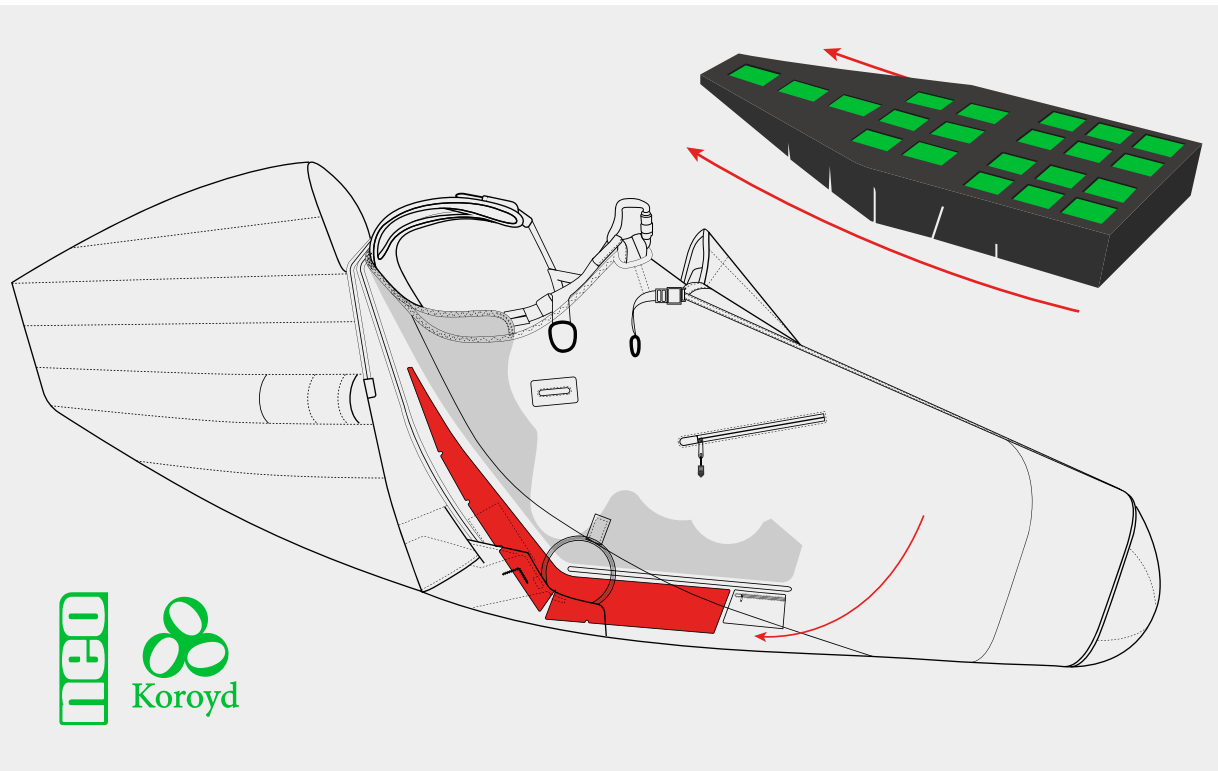

! WARNING: *The back protection does not eliminate the chance of injury as a result of a crash.*

! WARNING: *If the back protection zip is not fully closed, the protector will not work effectively*

! WARNING: *If the harness is subjected to temperatures exceeding 70 degrees Celsius the integrity of the back protection may be compromised.*

! WARNING: *The Koroyd 1.0 back protection has a valid lifetime of 5 years. The lifetime is a guide and may change depending on use, care and maintenance.*



G-CHUTE POCKET

The Genie Lite 3 has a dedicated pocket for a G-chute. Please refer to the G-Chute manual for correct operation in flight.

The pocket has a flap to close the pocket and retain the aerodynamic shape of the harness. After disabling the G-Chute it is possible to return it into the pocket but pilots may find it less time consuming to fly with the disabled G-chute and re-install it after landing.

 **G-Chute**

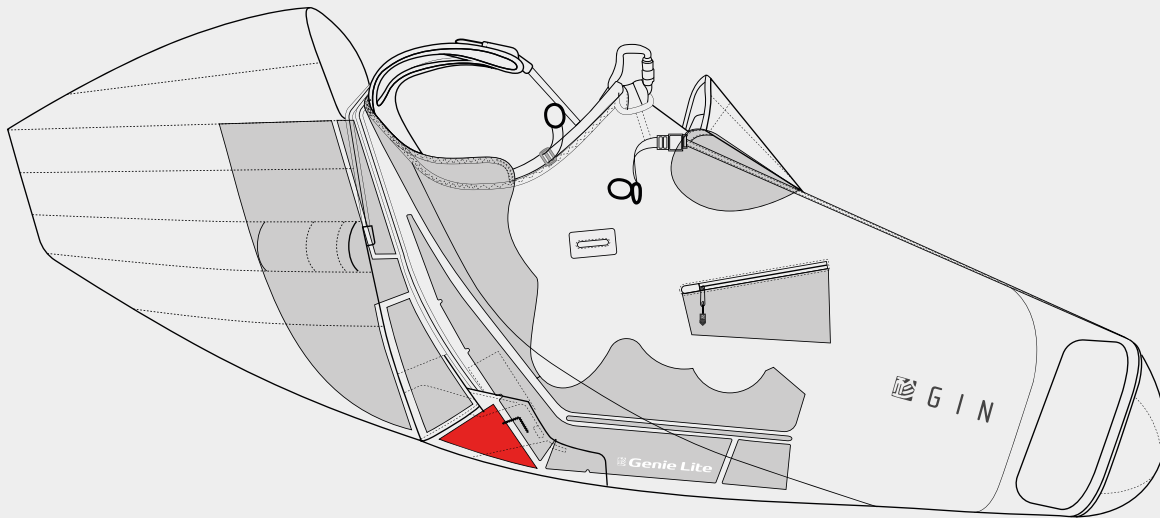

WARNING: Check the G-Chute manual before installing or using one.

RESCUE INSTALLATION

RESCUE INSTALLATION AND COMPATIBILITY CHECK

Gin Gliders recommend that rescue installation is performed properly by a competent person. The rescue parachute is a pilot's last resort and failure to pack or connect the reserve parachute in the correct way may cause death or severe injury. The pilot is responsible for ensuring proper installation.

This harness is compatible with the Yeti UL, G-Lite (please check rescue size and volume), Yeti and Yeti Cross rescue parachutes. Other manufacturers' rescues may also be used but we cannot guarantee their function. The pilot is responsible for checking compatibility.

Every first installation of a rescue system into the harness (that means every new combination of harness and rescue system) must be checked by a qualified paragliding professional for compatibility. To verify the installation, you must perform a test deployment by sitting in a simulator.

Rescue parachutes should be repacked at least every 150 days; so installing your rescue in a new harness may also provide a good opportunity for a repack. After every repack of the rescue parachute you should also do a compatibility check.

The harness is delivered with its own rescue container. All current GIN rescue inner containers can be added to the rescue deployment handle. This might not be the case for other manufacturers.

RESCUE COMPATIBILITY

MAKE SURE THAT THE RESCUE PARACHUTE CAN BE RELEASED FROM THE RESCUE CONTAINER—it must be done by you, the pilot, sitting in the harness hanging from a simulator.

RESCUE DEPLOYMENT

To deploy the rescue; locate the handle, with a firm grip pull the handle towards the pilot and slightly away from the harness to extract the rescue from the harness compartment. In the same motion that pulls the rescue from the compartment swing the rescue by the handle while looking for clear airspace (clear of lines, glider and harness). Release your grip of the handle and allow both handle and rescue to travel through the air extending the rescue lines as it goes. The rescue should come out of the deployment bag and start to inflate once the rescue lines have been extended.

In a negative spin the decent speed of the the pilot and wing is much less than in a spiral situation. Therefore it is very important to throw the rescue away from the pilot with as much power as possible to quickly extend the lines and prevent the rescue from becoming entangled with the paraglider.

For further information on rescue deployment please refer to your rescue manual.



! WARNING: If you are in any doubt about any aspect of rescue installation, seek professional advice!

I IMPORTANT: You must perform a test deployment from a simulator to verify the installation.

ATTACHING THE RESCUE DEPLOYMENT BAG TO THE HARNESS DEPLOYMENT HANDLE

The rescue container for this harness comes with its own deployment handle. This handle and its strap must be connected to the deployment bag of the parachute. In particular, check the length of the strap connecting the rescue deployment handle to the rescue inner container. It should be long enough that the reserve can be extracted without the danger of the pin not being pulled before the strap tightens on the reserve, but not so long that there is excessive slack that extends the movement required for deployment.

The deployment bag of other manufacturers' rescue systems (i.e. non-GIN rescue systems) may have different loop positions which may cause a deployment failure. Be sure to contact your parachute dealer or a qualified professional to check the connection, position and secure deployment, and refer to the rescue manual for details.



IMPORTANT: *The deployment bag of other manufacturers' rescue systems may have different loop positions which may cause a deployment failure.*

INNER BAG



Handle attachment



Pass the handle through the center loop



Pass the handle through itself



Pull to make a clean, tight knot

INNER CONTAINER PACKING

Your rescue should be repacked into the supplied inner containers as follows.



Place the folded rescue into the inner bag.



Fold 60cm of line under the rescue. Secure the suspension line using the central elastic band.



Fold the para-cord into symmetrical bundles the approximate width of the bag.

Use elastic bands to hold the loops and neatly stack the bundles at the bottom of the bag.



Close the bottom flap in the order shown.

There should be around 40cm of suspension line remaining to connect with the harness.

CONNECTING THE RESCUE BRIDLE

To connect a rescue to your harness we recommend using a GIN Rescue Carabiner. If you choose to use different type of connector, it should be rated at least 9 times the maximum weight. For example, our recommended 6mm Stainless Steel screwgate maillon (square) connector has a minimum breaking load of 12,5kN (1250 Kgf). It is the pilot's responsibility to check the compatibility of the rescue system and ensure that it is installed properly.

Be sure to inspect your connector during normal maintenance and safety checks. Replace it whenever there are any signs of wear and check your rescue system with a professional after any deployment. We recommend that you cover the connection using the Maillon rapid cover to prevent excess friction. Rubber-bands should also be used to secure the attachment and prevent excess friction.

Recommended by GIN: 6mm stainless steel screwgate maillon

6MM SQUARE MAILLON
BREAKING LOAD: 12,5KN

MAILLON CONNECTION *(RECOMMENDED BY GIN GLIDERS)*



⚠ WARNING: *When connecting the rescue bridle be sure to secure the connection using tape, rubber bands or heat shrink wrap. If the lines are not secure they may burn or cut from excess friction.*

❗ IMPORTANT: *Be sure to connect both rescue bridles to the rescue.*

RESCUE INSTALLATION GUIDE

It is very important to properly install the rescue parachute. If the parachute is not folded correctly or the lines are not placed properly then a serious if not fatal accident could result. If you have any doubts speak with your instructor or GIN dealer.

Main rescue installation guide

Begin by first connecting the bridles and the rescue handle to the rescue parachute. Install the rescue into the harness with the handle connection **FACING UP** and the extra para line neatly folded on the bottom of the container. Be sure that the inner bag is installed so the rescue handle loop is facing the opening of the rescue container (2)

Using the paracord included with your harness pull the built in loop through the metal rings in the order shown below.

First place flap A in the housing shown (3) then pull the loop through the first eyelet on the rescue container cover (4).

Next close the zipper for the rescue bridle tunnel and push the rescue handle wire through the right hand eyelet (5).

Pass the paracord through the left hand eyelet and pull from the inside of the harness (6). Secure the loop with the rescue handle wire (7).

Push the rescue handle wire into its housing and remove the paracord (8)

*Follow the instructions on the next page.

RECOMMENDED BY GIN: 6MM STAINLESS STEEL SCREWGATE MAILLON



⚠ WARNING: When installing the reserve make sure the reserve handle is up and the reserve lines are facing down.





STORAGE

BACK POCKET (1)

The back pocket is designed to store the pilots rucksack and other light accessories during flight.

HYDRATATION POCKET / PERSONAL BELONGINGS (2)

Located inside the back pocket is a smaller pocket that can hold a CamelBack or other small belongings.

RADIO POCKET (3)

Located inside of the back pocket is a radio pocket. At the top of the back pocket there a hole on the left side of the harness that can be used for a radio wire and/or hydration hose.

SIDE POCKET (4)

Located on right side of the harness, just under the carabiner, is one zippered pocket that can be used to store small items such as a snack or small digital camera during your flight.

COCKPIT POCKET (5)

The cockpit storage pocket is able to house approx. 4.5L of water ballast (M size) or a concertina bag or other small items. It is accessible in the air but the pilot will find the side pocket easier to access quickly.

UNDER SEAT POCKET (6)

The under seat pocket has a capacity for approx. 4L of ballast (M size) or other items. Bear in mind that any ballast placed here will affect the flying angle of the harness... you can use this to your advantage in fine tuning the harness; even 1kg will make a difference.

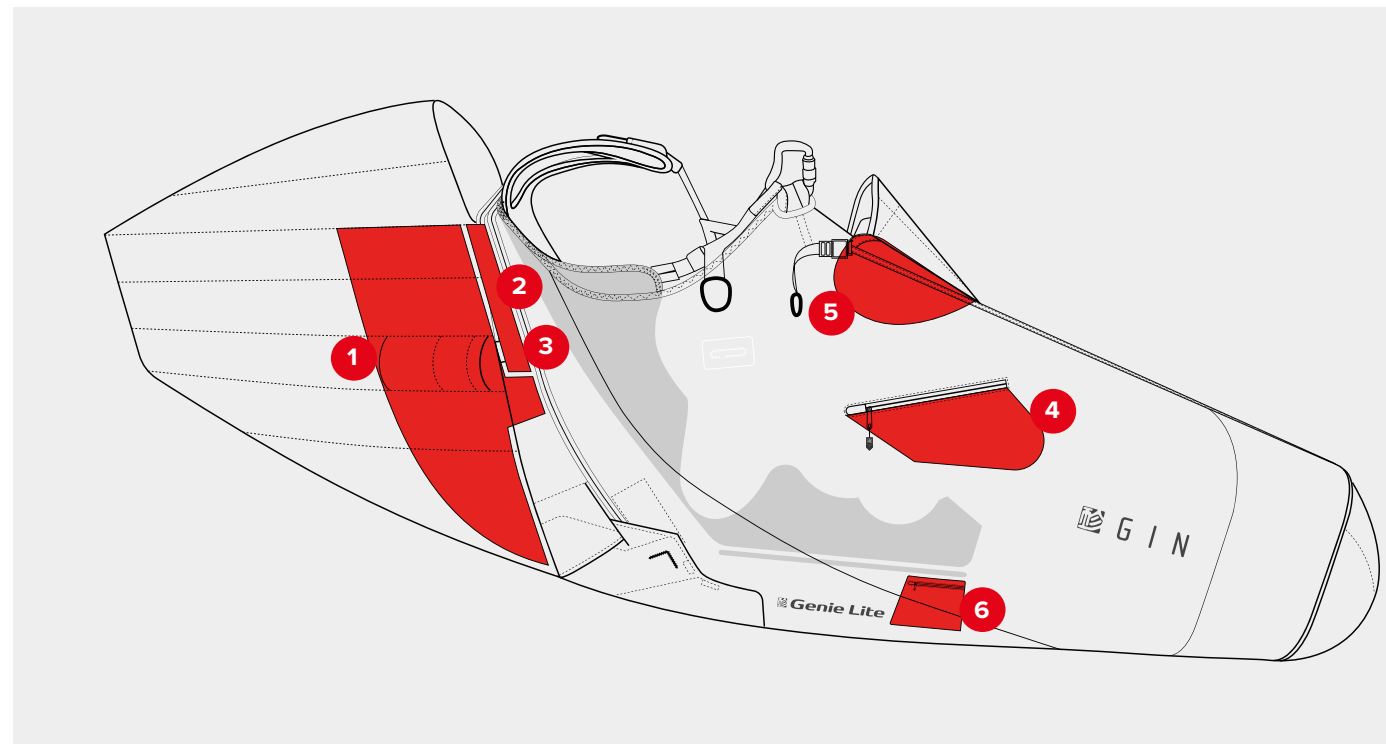

ADJUSTMENTS

After choosing a harness that is close to your body size, adjust your harness to suit your physique and flying style. It is important to adjust it correctly to ensure you can easily slide into the sitting position after take off. A poorly adjusted harness can adversely affect the flying characteristics of your paraglider.

Perform adjustments before your first flight by hanging in a simulator and fine-tune the settings if necessary during your first few flights.

SHOULDER STRAPS (1)

The optimum setting for the shoulder straps depends on the height of the pilot. Step into the harness and stand upright with the breast strap closed, symmetrically adjust the shoulder straps until they are a snug fit, but not tight.

To tighten: pull down on the black and red dotted loop

To loosen: pull up on the RED and black dotted loop on the top of the shoulder strap.

BREAST STRAP (2)

After adjusting the shoulder straps, place the breast strap in a comfortable position and tighten so there is slight pressure on the shoulder straps.

LEG STRAPS

The leg strap lengths are not adjustable.

ABS STRAPS (3)

ABS system can be adjusted by the chest strap with an easy trimming system. Flying with an open setting of the chest strap will make the harness more sensitive and it will help the pilot to be connected with the wing during thermaling or in smooth conditions.

When the pilot is on speedbar or if the conditions are rough, the closed setting offers the most stable behaviour, dampening all the movements of the wing.

NOTE: Make sure that the rescue system has been installed before making adjustments.



LATERAL STRAPS (1)

The lateral straps adjust the angle between the thighs and the back. Lengthening the straps increases the angle and vice-versa. The easiest way to adjust them correctly is during a flight in calm air. Remember that flying in the supine position (i.e. leaning back), reduces the stability of the harness and increases the risk of riser twists after a deflation.

TO TIGHTEN, PULL FORWARD ON BLACK AND RED LOOP. TO LOOSEN, PULL BACK ON THE BLACK LOOP.

SIDE STRAP (2)

The side adjustment straps allow you to adjust the angle of the lower back. To get the optimum setting you can loosen these straps to the maximum in the sitting position and start pulling the straps until you get the best comfort depending on the flying style of the pilot.

TO TIGHTEN, PULL UP ON THE RED LOOP. TO LOOSEN, PULL UP ON THE BUCKLE.

SPEED BAR

Hanging in the simulator, adjust the length of the speed bar cord so that the bar hangs at least 15cm below the front of the harness. Making the cord too short could result in the speed system being constantly or unintentionally engaged during flight. It is safer to start with the speed bar a little long and shorten it following your first flights. Test the speed bar in flight only after you are comfortable with your new harness, and always do so in calm conditions with enough clearance above the ground.

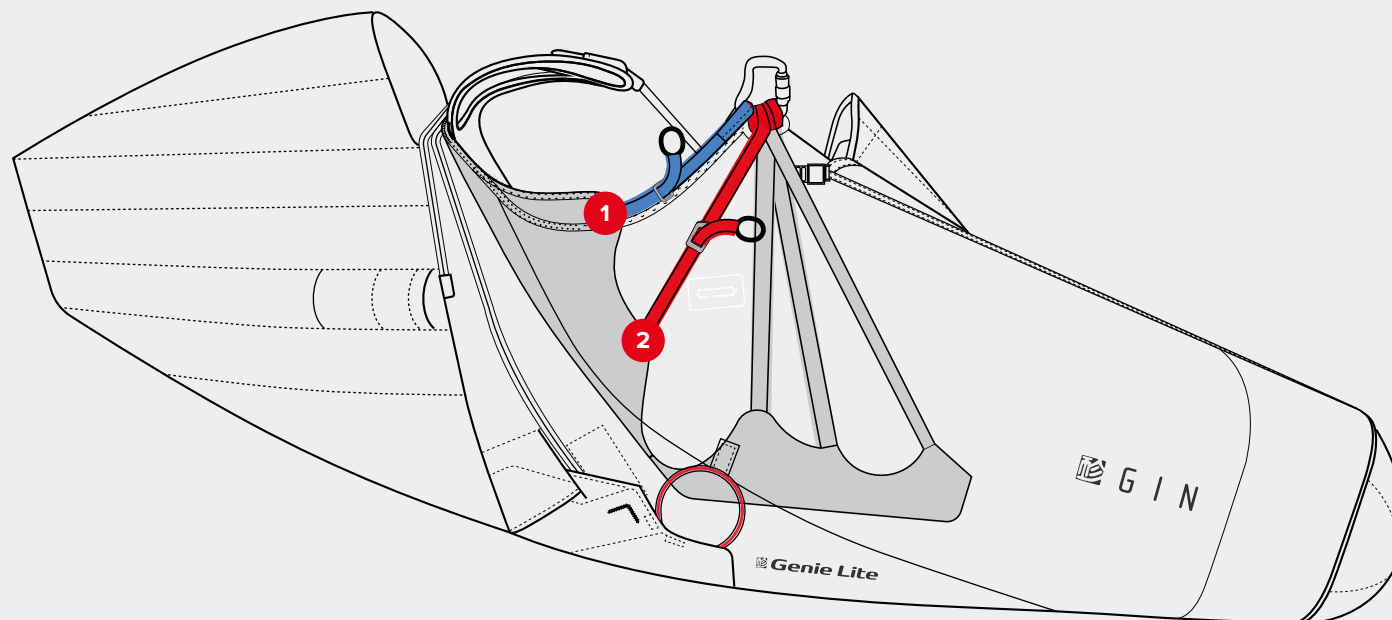

- 1 LATERAL STRAP
- 2 SEAT STRAP

COCOON ADJUSTMENTS

The cocoon should be tight and the harness fabric should be smooth and wrinkle-free to create the most aerodynamic shape. The nose of the cocoon should form a straight line and point slightly down.

- (1)** Tighten the upper line to raise the nose of the cocoon, loosen to allow the nose to drop and extend the length of the cocoon.
- (2)** Tighten the diagonal line to adjust the overall length of the pod
- (3)** Tighten the lower line to pull the nose more down or loosen to allow the nose to point more upwards.

There are 3 markers on each adjustment line to indicate the minimum (-5), middle (0) and maximum (+5) adjustment settings for the cocoon.

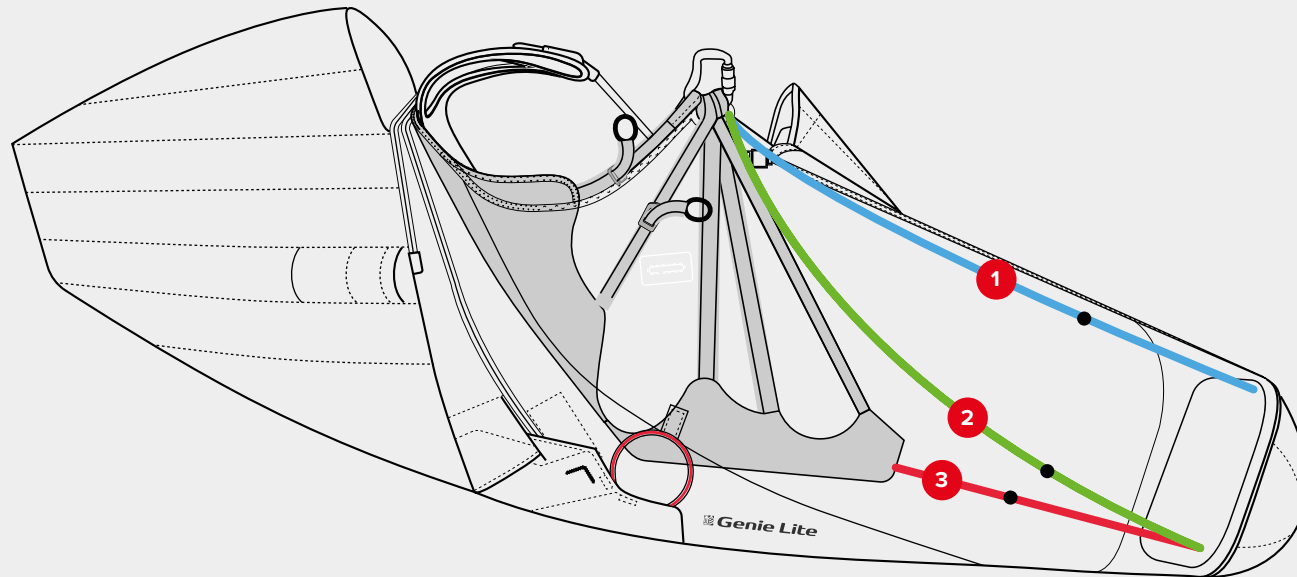

FLYING WITH THE GENIE LITE 3

General warnings and advice

Before every flight, check the following:

- ⊙ Are you in good physical and mental condition?
- ⊙ Are you familiar and compliant with all applicable laws and regulations in your area?
- ⊙ Are you within the certified weight range of your paraglider?
- ⊙ Do you have the necessary valid insurance cover (e.g. liability, medical, life)?
- ⊙ Are you briefed thoroughly about the site, airspace and expected weather conditions of the day?
- ⊙ Is your equipment and choice of site suitable for your level of experience?
- ⊙ Do you have a suitable helmet, gloves, boots, eye-wear and adequate clothing?
- ⊙ Are you carrying some form of identification, so that people know who you are in case of an accident?

Take along a radio and mobile phone if possible.

- ⊙ Do you fully understand how to safely use your new equipment? If not, have your instructor or dealer explain anything you are not sure about.

When you go for your first flight on your new harness, be sure to pick a day and site that does not present you with any unfamiliar challenges. During your first flight, familiarize yourself with the in-flight characteristics of your new harness.

Pre-flight checks

As part of your normal pre-flight check routine, check:

- ⊙ Is there any damage to the harness or carabiners that could affect its airworthiness?
- ⊙ Is the rescue parachute container closed correctly with the pins in the right position?
- ⊙ Is the deployment handle correctly inserted or attached?
- ⊙ Are all buckles, belts, zips securely fastened? Buckles should click into place as you close them, and a gentle pull on the fastened buckle verifies this. Secure any zips after fastening the buckles. Take extra care in snowy or sandy environments.
- ⊙ Is the paraglider connected correctly to the harness with both carabiners secured by their locking mechanisms?
- ⊙ Is the speed bar attached correctly to the glider?
- ⊙ Are all pockets closed properly and any loose items tied down safely?
- ⊙ Is the air chamber intake open and clear?
- ⊙ Have you closed your leg and chest straps? Double check before you take off!



i IMPORTANT: Use a complete and consistent system of pre-flight checks and repeat the same sequence every flight.

i IMPORTANT: The maximum clip in weight of the Genie Lite 3 is 120kg, we do not recommend you fly with more than this weight.

Rescue Deployment

In the event of an emergency, you must quickly evaluate your height and the seriousness of the incident. A seconds hesitation in deploying the reserve could prove fatal if there is insufficient height. On the other hand, deploying the rescue when the glider is recoverable may result in needless injury.

If you decide to deploy the rescue:

- 1) Look for the rescue handle and grasp it firmly with one hand
- 2) Pull forwards and upwards on the handle to release the deployment bag from the rescue container.
- 3) Look for a clear area, and in a continuous motion, throw (and RELEASE!) The rescue away from yourself and the glider, preferably into the air stream or against the direction of spin. After deployment, avoid entanglement and pendulum motions by promptly pulling in the glider as symmetrically as possible with the B, C, D or brake lines.
- 4) On landing take an upright body position and be prepared to do a PLF (Parachute Landing Fall) to minimize the risk of injury.

Landing with the Genie Lite³

Before landing, slide your legs forward in the harness so that you adopt the standing position. NEVER land in the seated position—it is very dangerous even if you have back protection. Standing up before landing is an active safety precaution.



i IMPORTANT: *In normal flight, periodically feel the position of the rescue handle so that the action of reaching for the rescue handle is instinctive in an emergency.*

! WARNING: *During any incident in flight, always monitor your altitude. If you have any doubt that you have sufficient height for recovery, deploy your reserve without hesitation. “If in doubt, get it out!”.*

NOTE: *After any rescue deployment, it is essential to have your harness thoroughly inspected by a qualified professional to be sure there is no damage to the rescue connection points, rescue bridle or any other parts.*



Towing

The Genie Lite 3 can be used for towed launches. The Gin Towing Bridle can be hooked directly to the main carabiners. For further details, refer to the documentation provided with your tow release, or ask a qualified towing instructor at your flying site.



Tandem Flying

The Genie Lite 3 is not designed for tandem flying. See www.gingliders.com for details of our harnesses specifically designed for tandem flying.



Flying over water

Water landings should be avoided at all costs, as the back protection increases the risk of the pilot floating in a head-down position. For safety training over water, we recommend wearing a proper flotation vest with a head support holding the wearer's head above the surface even when unconscious.

MAINTENANCE AND REPAIRS

The materials used in this harness have been carefully selected for maximum durability. Nevertheless, keep your harness clean and airworthy to ensure the longest possible period of safe operation.

Care and maintenance

Don't drag your harness over rough or rocky ground. Avoid unnecessary exposure to UV rays, heat and humidity. Keep the folded harness in your rucksack when not in use.

Store all your equipment in a cool, dry place, and never put it away while damp or wet. Regularly clean off dirt with a plastic bristled brush and/or a damp cloth. If the harness gets exceptionally dirty, wash it with water. Make sure you first remove the entire sub-components for example, rescue parachute etc. Allow the harness to dry naturally in a well ventilated area away from direct sunlight. If your rescue parachute ever gets wet (e.g. in a water landing) you must separate it from the harness, dry it and repack it before putting it back in its separate deployment bag.

After a hard landing you must check your harness and back protector for damage, pay close attention to the rescue container and verify all of the attachments are secure.

Inspection checklist

The pilot should perform the following inspection on every repack of the rescue and should be checked by a professional after 24 months or 200 hours of flying, whichever comes first. Additional inspections should be performed after any crash, bad landing or take off, or if there are any signs of damage or undue wear. Always seek professional advice whenever in doubt.

! IMPORTANT: *Any repairs should only be carried out by the manufacturer or by an approved agent. This will ensure that the correct materials and repair techniques are used.*

! IMPORTANT: *No harness should ever be flown if there is any kind of damage to the webbing.*

The following checks should be carried out:

- ⊙ Check all webbing, straps and buckles for wear and damage (ex. open seams, tearing or cutting), especially the areas that are not easily seen, such as the inside of the carabiner hook-in points.
- ⊙ All sewing must be intact and any anomalies attended to immediately to avoid exacerbation of the problem.
- ⊙ Special attention should be paid to the rescue installation, particularly the elastic and Velcro parts.
- ⊙ The main carabiners must be replaced at least every 5 years or after 500 hours, whatever comes first. Impacts may create undetectable cracks that could result in structural failure under continuous load.
- ⊙ A careful visual inspection of the protector should be made, airbags should be filled with air and checked for leaks, mousbag should be inspected for tears and foam recovery.

Repairs

The manufacturer or an official GIN dealer should carry out any repair that involves critical parts of the harness. This will ensure that the correct materials and repair techniques are used.

Storage

Stored at a temperature between 10° and 25° C and in relative humidity between 50 and 75%. Make sure that the harness is not stored in a place where animals such as mice or cats could use it as a place to sleep.

Do not store the harness near any chemicals (including water). Petrol, for example, causes the material to disintegrate and can cause considerable damage to your harness. When your equipment is in the car boot, keep it as far away as possible from any spare petrol cans or oil containers.

The harness should not be exposed to extreme heat. High temperatures accelerate the process of hydrolysis, particularly when combined with moisture, which damages fibers and coating. Do not store your harness near radiators or other heat sources.

If you find your Aerocone not inflating well, consider to put less items in the back pocket, as the air intake might be blocked



GIN quality and service

We take pride in the quality of our products and are committed to putting right any problems affecting the safety or function of your equipment and which are attributable to manufacturing faults. Your GIN dealer is your first point of contact if you have any problems with your equipment.

If you are unable to contact your dealer or GIN importer, contact Gin Gliders directly via our website.

GIN lifetime guarantee

Gin Gliders are proud to guarantee the quality, craftsmanship and performance of all our products. Equipment with defects in materials or manufacturing will be repaired or replaced at the discretion of Gin Gliders for the practical lifetime of the product. Equipment damaged through wear and tear, misuse or neglect may be repaired at a nominal charge.

If you have any problems with your equipment, please contact your GIN dealer in the first instance, or Gin Gliders directly via our website.

Care of the environment

We are privileged to fly in areas of outstanding natural beauty. Respect and preserve nature by minimizing your impact on the environment. When visiting an area, contact the local club for details of environmentally sensitive areas and local restrictions.

Gin Gliders gives consideration to the entire life cycle of its harnesses, the last stage of which is recycling in an environmentally-friendly manner. The synthetic materials used in a harness must be disposed of properly. If you are not able to arrange appropriate disposal, Gin Gliders will be happy to recycle the harness for you. Send the harness with a short note to this effect to Gin Gliders Inc.

Product registration

Register this product to receive safety updates, and improved guarantee and repair service.

www.gingliders.com/register



FINAL WORDS...

Most of us today live in a dependent society where we are regulated and protected. There are few opportunities for individuals to develop the self-responsibility that is the foundation of safety in extreme sports such as paragliding.

Most accidents are caused by getting into situations that are too demanding for your level of experience. This happens if you lack fundamental understanding, are incapable of assessing the risk or simply do not pay sufficient attention to your surroundings or your own state of mind.

To stay safe, the best you can do is to increase your understanding, skill and experience at a rate you can manage safely. There is no substitute for self-responsibility and good judgment.

In the end, paragliding offers a unique opportunity to learn to take control of your own destiny. Memento mori, carpe diem!



G I N

Fly safely, and...**ENJOY!**

GIN team

TECHNICAL DATA

Size	XS	S	M	L
Carabiner distance (cm)	34-43	34-43	36-46	40-49

CERTIFICATION

The Genie Lite³ is **EN** and **LTF** certified, max load 120 daN
 Certification number: **PH 277.2019** | **CE** certification

PARACHUTE CONTAINER

Integrated container underneath seat plate

BACK PROTECTION

KOROYD 9cm Back Protection

MATERIALS

Harness fabric	
Outer	Rosetta 70 D / Babyrip 210 Dark Grey
Inner	Nylon HD 210
Webbing	Nylon HD 210Nylon 20mm
	Polyester 30mm/25mm/20mm
Thread	100% Polyester, P/F 210D/9 bonded, P/F 210D/4 bonded & P/F 210D/6 bonded

PILOT DETAILS / PROOF OF OWNERSHIP

1. Owner

Name:

Address:

Phone:

Email:

2. Owner

Name:

Address:

Phone:

Email:

3. Owner

Name:

Address:

Phone:

Email:

HARNESSES DETAILS

Size	Colour	Serial Number
Check flight (date):		
Mark and signature:		

INSPECTIONS AND REPAIRS OVERVIEW

Date	Work carried out	General conditions on delivery	Completed by (name)	Stamp and signature

HARNESSE DIAGRAM

- 1. Back pocket
- 2. Rescue container
- 3. Foot plate
- 4. Upper cocoon adjustment
- 5. Lower cocoon adjustment
- 6. Speed system hook
- 7. Speed system Pulley
- 8. Speed bar
- 9. Back protector
- 10. Rescue handle
- 11. Hook knife

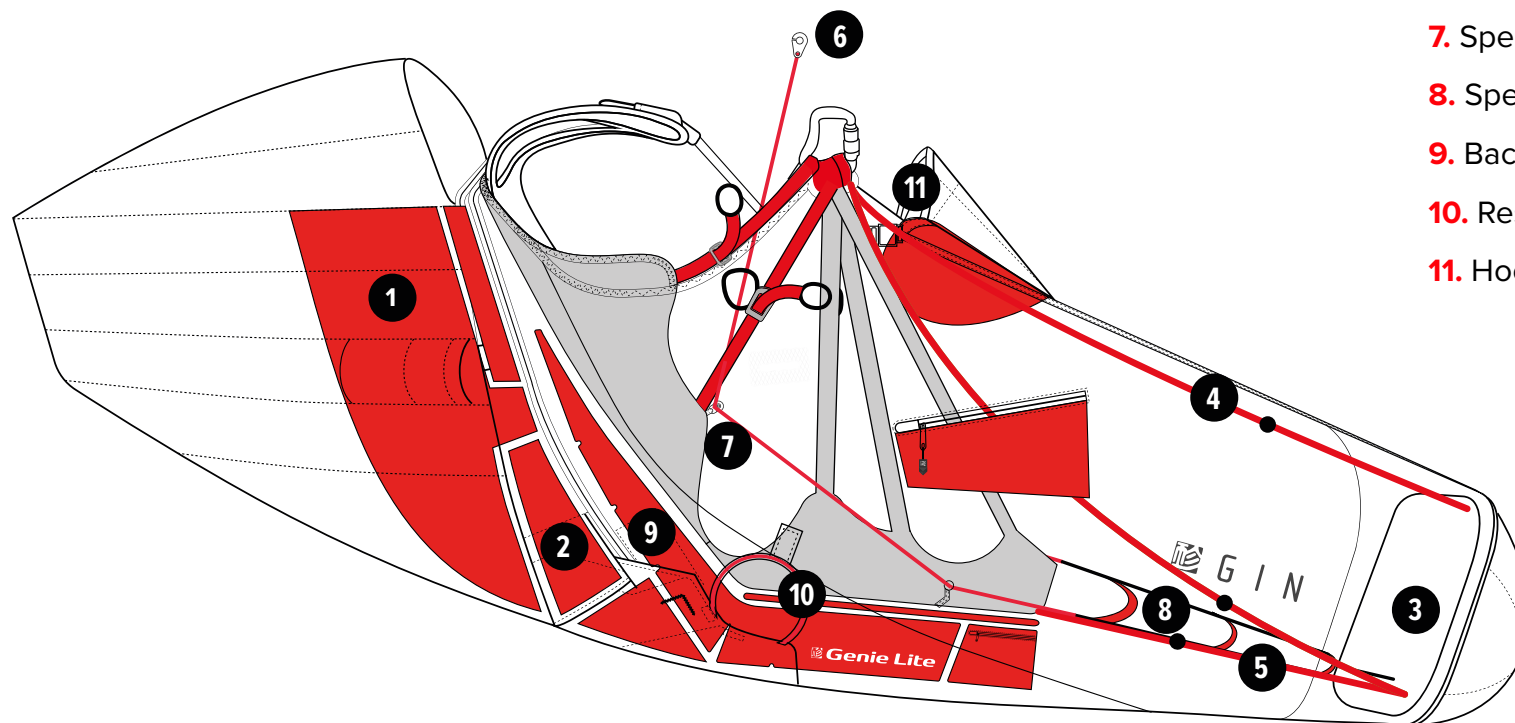



Gin Gliders INC.

2318-32, Baegok-daero, Moyheon-myeon,
Cheoin-gu, Yongin, Gyeonggi-do, Korea
17063

tel. +82 (0)31 333 1241

fax. +82 (0)31 334 6788

gin@gingliders.com

www.gingliders.com