



USER'S MANUAL

DIGIFLY AIR-SE AIR-BT AIR-BT-PITOT

Ver. 410b – English – Rev.2

CONGRATULATIONS

Thank you for choosing Digifly!

You have purchased a high technology instrument designed expressly for free flight. The multiple functions and flight data it provides, effectively make it an on-board computer. Learning to use this instrument will make your flying easier in terms of performance and safety; it will enable you to improve your flying technique and make quicker piloting decisions thanks to the comprehensive flight information that is provided. Another benefit is the ability to download and analyze your flight data afterwards.

The instrument has been designed to allow for future software developments to be easily incorporated via the Internet.

Before you get started, make sure you have downloaded the free Digifly software for your AIR's management, AirTools, AirPages and AirUpdater, from our website www.digifly.com

DIGIFLY INTERNATIONAL GUARANTEE

Dear Customer,

Thank you for purchasing this Digifly product which has been designed and manufactured to the highest quality standards. Digifly warrants this product to be free from defects in materials and workmanship for 3 years from the date of purchase.

The Digifly guarantee applies provided the product is handled properly for its intended use, in accordance with its operating instructions and upon presentation of the original invoice or cash receipt, indicating the date of purchase, the dealer's name, the model and the serial number of the instrument.

The customer is however, responsible for any transportation costs. The unit must be securely packaged for return.

The Digifly guarantee may not apply if:

- The documents have been altered in any way or made illegible.
- Repairs or product modifications and alterations have been executed by unauthorized person or service.
- Damage is caused by accidents including but not limited to lightning, water or fire, misuse or neglect, or every malfunction not related to manufacturing defects of your instruments.

If your Digifly product is not working correctly or is defective, please contact your Digifly dealer, in order to avoid unnecessary inconvenience.

Digifly Europe s.r.l.

Bologna

Italy

www.digifly.com

info@digifly.com



1	INDEX	3
1	INDEX.....	3
2	GETTING STARTED	7
2.1	CONNECTIONS AND SENSORS	7
2.2	BATTERY	7
2.2.1	BATTERY RECHARGE.....	7
2.2.2	EXTERNAL POWER SUPPLY.....	7
2.3	KEYBOARD - NORMAL OR LONG KEY PRESS	8
2.4	POWER ON & OFF	8
2.5	DISPLAY CONTRAST ADJUSTMENT.....	8
2.6	MENU.....	8
2.6.1	STANDARD FIELDS EDITING.....	8
2.6.2	ALPHANUMERICAL FIELDS EDITING.....	9
2.7	MULTI LANGUAGE HELP.....	9
2.8	RESTORE FACTORY SETTINGS.....	9
2.9	RESET	9
3	QUICK REFERENCE GUIDE	10
3.1	SYMBOLS.....	10
3.2	PAGES.....	11
3.2.1	CONFIGURABLE PAGES	11
3.2.2	MANUAL PAGE SWITCHING	11
3.2.3	AUTOMATIC PAGE SWITCHING (INTELLIFLY).....	11
3.3	COMPETITION PAGES.....	13
3.3.1	PAGE 1 COMP FLIGHT (THERMAL) AND PAGE 2 COMP FLIGHT (GLIDE).....	13
3.3.2	PAGE 3 COMP START (THERMAL) AND PAGE 4 COMP START (GLIDE)	14
3.3.3	PAGE 5 COMP GOAL (THERMAL) AND PAGE 6 COMP GOAL (GLIDE).....	15
3.4	CROSS COUNTRY (XC) PAGES.....	16
3.4.1	PAGE 7 XC (THERMAL)	17
3.4.2	PAGE 8 XC (GLIDE).....	18
3.5	PAGE 9 COMPASS.....	19
3.6	PAGE 10 RELAX	20
3.7	PAGE 11 AHRS.....	20
3.8	PAGE 12 MAP	21
3.9	PAGE 13 MASTER INFO GPS PAGE	22
3.9.1	GPS STATUS INFORMATION	23
3.9.2	LATITUDE & LONGITUDE COORDINATES.....	23
3.9.3	LATITUDE & LONGITUDE COORDINATES OPTIONS.....	23
3.9.4	GPS SIGNAL QUALITY (HDOP)	23
3.9.5	GPS ALTITUDE	23
3.9.6	GPS DIRECTION (TRK).....	23
3.9.7	GPS GROUND SPEED.....	23
3.9.8	REAL TIME NAVIGATION MANAGER / SKIP WAYPOINT.....	23
3.9.9	CREATING A NEW WAYPOINT USING THE CURRENT POSITION (MARK).....	24
3.9.10	NAVIGATION TO "HOME" WAYPOINT (GOTO HOME)	24
3.9.11	DEACTIVATING THE CURRENT NAVIGATION (CLEAR NAV)	24
3.9.12	DATE & TIME.....	24
4	MAIN FUNCTIONS	25
4.1	ALTIMETERS	25
4.1.1	ALTIMETERS' SETTINGS	25
4.2	VARIOMETERS.....	26
4.2.1	10-SENSORS VARIOMETER WITH SELF-ADAPTIVE SENSITIVITY	26
4.2.2	DIGITAL VARIO.....	26
4.2.3	ANALOGICAL VARIO	26
4.2.4	INTEGRATED (AVERAGE) VARIO.....	26
4.2.5	NET VARIO (WITH OPTIONAL PITOT TUBE)	26
4.2.6	INTEGRATED VARIO / NET VARIO AUTOMATIC SWITCH.....	27

4.2.7	McCREADY (WITH OPTIONAL PITOT TUBE).....	27
4.2.8	EQUIVALENT McCREADY (WITH OPTIONAL PITOT TUBE)	27
4.2.9	TOTAL ENERGY COMPENSATION (WITH OPTIONAL PITOT TUBE).....	28
4.2.10	ACOUSTIC VARIO	29
4.2.11	ACOUSTIC VARIO PRE-THERMAL TONE.....	29
4.2.12	VARIO SIMULATOR.....	29
4.3	AIRSPPEED (WITH OPTIONAL PITOT TUBE).....	30
4.3.1	AIRSPPEED CALIBRATION (WITH OPTIONAL PITOT TUBE)	30
4.4	SPEED DIFFERENCE (WITH PITOT TUBE)	30
4.5	SPEED TO FLY (WITH OPTIONAL PITOT TUBE)	31
4.6	POLAR (WITH OPTIONAL PITOT TUBE)	32
4.7	BAROMETER.....	33
4.8	TIME.....	33
4.9	AUTOMATIC CHRONOGRAPH	33
4.10	PILOT'S NAME & GLIDER'S INFO	33
5	ADVANCED FUNCTIONS	34
5.1	MAGNETIC COMPASS (HEADING).....	34
5.2	G-METER.....	34
5.3	INERTIAL PLATFORM (AHRS)	34
5.3.1	PITCH.....	34
5.3.2	ROLL	34
5.3.3	YAW.....	34
6	GPS FUNCTIONS.....	35
6.1	INTEGRATED GPS RECEIVER WITH 99 CHANNELS.....	35
6.2	GPS STATUS INFORMATION.....	35
6.3	GPS SIGNAL QUALITY (HDOP)	35
6.4	LATITUDE & LONGITUDE COORDINATES.....	35
6.5	LATITUDE & LONGITUDE COORDINATES OPTIONS.....	35
6.6	GPS ALTITUDE	35
6.7	GPS GROUND SPEED	35
6.8	GPS DIRECTION (TRK).....	35
6.9	GROUND EFFICIENCY (GLIDE RATIO)	35
6.10	WIND SPEED AND DIRECTION INDICATION USING GPS.....	36
6.11	LAST THERMAL POSITION, DISTANCE & HEIGHT INFORMATION	37
6.12	THERMAL ASSIST.....	37
6.13	THERMAL TUTOR.....	37
6.14	PLOTTER.....	38
6.15	MAP.....	39
6.15.1	TERRAIN (FIRST LAYER):	39
6.15.2	NAV (SECOND LAYER).....	41
6.15.3	AIRSPACE CTR (THIRD LAYER).....	41
6.16	3D AIRSPACE MANAGER.....	41
6.16.1	UPLOAD AND ENABLE AIRSPACE CTRs TO THE DIGIFLY AIR	42
6.16.2	VISUAL AND ACOUSTIC DISTANCE WARNING TO THE CTR.....	43
6.16.3	CTR's HORIZONTAL DISTANCE INDICATOR.....	43
6.16.4	CTR's VERTICAL DISTANCE INDICATOR.....	43
7	WAYPOINT MANAGEMENT	44
7.1	WAYPOINT DATABASES: COMPETITION & USER	44
7.1.1	MANUALLY CREATING A NEW WAYPOINT.....	44
7.1.2	CREATING A NEW WAYPOINT USING THE CURRENT POSITION (MARK).....	44
7.1.3	EDIT WAYPOINT.....	44
7.1.4	DELETE WAYPOINT.....	44
8	NAVIGATE TO A SINGLE WAYPOINT (GOTO).....	45
8.1	ACTIVATING NAVIGATION TO A WAYPOINT (GOTO).....	45
8.1.1	NAVIGATION TO WAYPOINT HOME (GOTO HOME).....	45
8.1.2	NAVIGATION TO THE NEAREST LANDING ZONE (GOTO LANDING).....	45
8.1.3	NAVIGATION TO THE NEAREST WAYPOINT (GOTO NEAREST).....	45

8.1.4	NAVIGATION TO A GENERIC WAYPOINT (GOTO).....	46
8.1.5	DEACTIVATING NAVIGATION TO A WAYPOINT (CLEAR NAV).....	46
8.2	NAVIGATION'S FUNCTIONS TO A SINGLE WAYPOINT (GOTO)	47
8.2.1	DIRECTION, DISTANCE & HEIGHT TO THE CURRENT WAYPOINT	47
8.2.2	COMPASS TO THE CURRENT WAYPOINT.....	47
8.2.3	REQUIRED GLIDE RATIO TO THE CURRENT WAYPOINT.....	47
8.2.4	ARRIVAL HOUR, ARRIVAL TIME TO THE CURRENT WAYPOINT.....	47
8.2.5	HSI GRAPHIC INDICATION TO THE CURRENT WAYPOINT.....	47
9	ROUTE MANAGEMENT	48
9.1	ROUTES OVERVIEW	48
9.2	VISUALIZING WAYPOINT INFO OF A ROUTE.....	48
9.3	INSERT A WAYPOINT IN A ROUTE.....	48
9.4	SUBSTITUTING A WAYPOINT IN A ROUTE	48
9.5	MODIFY A WAYPOINT IN A ROUTE (PARAMETER CHANGE)	49
9.6	DELETE A WAYPOINT OF A ROUTE.....	50
9.7	DELETING A ROUTE	50
9.8	NAVIGATION TO CONCENTRIC WAYPOINTS	50
10	ROUTE NAVIGATION.....	51
10.1	ACTIVATING A ROUTE.....	51
10.2	DE-ACTIVATING A ROUTE (CLEAR NAV)	51
10.3	OPTIMIZED NAVIGATION	51
10.4	NAVIGATION TO A STANDARD WAYPOINT	52
10.4.1	DIRECTION, DISTANCE & HEIGHT OVER THE CURRENT WAYPOINT	52
10.4.2	COMPASS TO THE CURRENT WAYPOINT.....	53
10.4.3	REQUIRED GLIDE RATIO TO CURRENT WAYPOINT	53
10.4.4	ARRIVAL TIME & TIME TO CURRENT WAYPOINT.....	53
10.4.5	HSI GRAPHIC NAVIGATION TO CURRENT WAYPOINT	53
10.4.6	DISTANCE & HEIGHT OVER THE ARRIVAL WAYPOINT (GOAL)	53
10.4.7	REQUIRED GLIDE RATIO TO GOAL.....	54
10.4.8	ARRIVAL TIME & TIME TO GOAL.....	54
10.4.9	CROSS TRACK ERROR (XT)	54
10.5	NAVIGATION TO THE START WAYPOINT (GATE)	55
10.5.1	STARTING TIME (TSTART).....	56
10.5.2	REMAINING TIME TO START (CSTART)	56
10.5.3	EXPECTED ARRIVAL TIME TO START LINE (ESTART).....	56
10.5.4	REQUIRED SPEED TO START THE CYLINDER LINE (STS).....	56
10.6	OPERATION CHECKLIST BEFORE A TASK.....	56
11	FLIGHT RECORDER.....	57
11.1	ACTIVATING / DE-ACTIVATING THE FLIGHT RECORDER	57
11.1.1	RECORDING MODE: AUTOMATIC START "AUT".....	57
11.1.2	RECORDING MODE: ALWAYS ACTIVE "ALW".....	57
11.1.3	RECORDING MODE "OFF".....	57
11.2	RECORDING RATE	57
11.3	LOG BOOK MANAGEMENT (LOG BOOK).....	58
12	ADDITIONAL MEMORY CARD	58
13	CONNECTIONS & INTERFACES	59
13.1	USB CABLE CONNECTION	59
13.2	BLUETOOTH CONNECTION (AIR-BT ONLY).....	61
13.2.1	BLUETOOTH "PAIRING".....	61
13.2.2	BLUETOOTH COMMUNICATION WITH MANAGEMENT SOFTWARE OF THE INSTRUMENT.....	61
13.2.3	BLUETOOTH COMMUNICATION WITH SOFTWARE DECODING THE DIGIFLY TELEMETRY	62
14	SOFTWARE.....	63
14.1	AIR MANAGEMENT SOFTWARE.....	63
14.1.1	DIGIFLY AIRTOOLS (PC / Mac) SOFTWARE	63
14.1.2	DIGIFLY AIRPAGES SOFTWARE FOR PC OR Mac).....	64
14.1.3	GpsDUMP SOFTWARE (PC, Mac, ANDROID)	67

14.2	DIGIFLY AIRUPDATER SOFTWARE FOR FIRMWARE UPDATE (PC, Mac).....	68
14.2.1	<i>FIRMWARE UPDATE PROCEDURE</i>	68
15	DIGIFLY TELEMETRY: HIGH SPEED REAL TIME DATA OUTPUT (AIR-BT ONLY)	69
15.1	ACTIVATE THE DIGIFLY'S TELEMETRY DATA OUTPUT	69
15.2	TELEMETRY DATA SELECTION	69
15.3	DIGIFLY TELEMETRY DATA CONNECTION WITH XCSOAR (AIR-BT ONLY)	71
15.4	DIGIFLY'S TELEMETRY CONNECTION WITH XCTRACK (AIR BT ONLY)	73
15.5	DIGIFLY TELEMETRY DATA CONNECTION WITH LK8000 (AIR-BT ONLY)	74
15.6	DIGIFLY'S TELEMETRY CONNECTION WITH TOPHAT (AIR BT ONLY).....	74
16	APPENDIX	75
16.1	DIGIFLY AIR STANDARD ACCESSORIES	75
16.2	OPTIONAL ACCESSORIES.....	75
16.3	TECHNICAL FEATURES	75
16.3.1	<i>STANDARD FUNCTIONS</i>	75
16.3.2	<i>ADVANCED FUNCTIONS</i>	76
16.3.3	<i>GPS FUNCTIONS</i>	76
16.3.4	<i>GENERAL SPECIFICATIONS</i>	76
16.4	MAIN SET UP MENU PARAMETERS	78
16.5	ADV-SETUP PARAMETERS MENU (ADVANCED SETUP)	79
16.6	VARIOMETER SETUP PARAMETERS.....	79

2 GETTING STARTED

2.1 CONNECTIONS and SENSORS



- The dual purpose mini USB socket allows the Digifly AIR to be recharged via the supplied Digifly 5v charger and, additionally, to be connected to a personal computer or Mac for configuration & flight data management.
- Micro SD card slot
- Bluetooth connection (AIR-BT only)
- GPS - 99 channels
- Barometer (atmospheric pressure sensor)
- Integrated Anemometer – pitot tube (optional)
- AHRS – 3-axis inertial platform
- Magnetic Compass
- Accelerometer



2.2 BATTERY

- The main power is supplied by an internal rechargeable high capacity lithium battery, that has no memory effect, so it can be partially recharged, without affecting the battery's life. It also has a very low self-discharge rate (more than one year) and works very well at low temperatures. A fully charged battery will power the instrument for over 30 hours.
- When the battery's icon starts to blink, there are roughly 4 hours of battery life remaining.

2.2.1 BATTERY RECHARGE

- To recharge the instrument, connect it to a power source with the USB cable.
- The required time for a full charge is about 8 hours.
- There are no problems if you leave the vario charging for more than 8 hours, as the vario automatically switches to a "maintain mode" preventing the battery from being overcharged.
- The Digifly AIR's lithium battery has no "memory effect", so it can be also partially charged.





2.2.2 EXTERNAL POWER SUPPLY

- The mini USB socket can be used to power the instrument and simultaneously charge the internal battery. With an external power bank, it could be charged during flight (instrument on).
- An external stabilized 5VDC power supply (e.g. a solar panel, external power bank, etc.) with a minimum of 150mA is necessary to turn the instrument on; any excess power will be used to charge the internal lithium battery. Proper solar panels are suitable to power the instrument.





2.3 KEYBOARD - NORMAL OR LONG KEY PRESS

- The time length you keep the keys pressed on your Digifly instrument selects the available functions.
 - For a **normal press**: press the button for less than a second
 - For a **LONG PRESS**: keep the button pressed down for at least 2 seconds
- Note:** When not specified, the key press has to be considered as a normal key press (less than a second).





2.4 POWER ON & OFF

- To **turn** your Digifly AIR **on**, press the  key for at least 4 seconds.
- To **turn** your Digifly AIR **off**, press the  key for at least 4 seconds. If the logger is recording, you will be prompted to confirm your choice by pressing the  key or, to cancel, press the  key; it will automatically cancel the request within 3 seconds of no input.
- After switching off your Digifly, you must wait at least 3 seconds before attempting to turn it on again; this prevents unwanted operation.
- After turning on your Digifly instrument, the first screen briefly shows the vario model, pilot name (if set), microSD status, logger status, vario serial number, firmware version and battery voltage.

2.5 DISPLAY CONTRAST ADJUSTMENT







- To change the contrast of the display, press the  key to enter the “MAIN SETUP” menu, select CTRS (MAIN SETUP \ n. 1 CTRS), go to the edit mode pressing the  key, set the preferred contrast using the keys: ‘arrow UP’  or ‘arrow DOWN’ , then save the changes by pressing the  key.

2.6 MENU

- To navigate the menus of your instrument, press the  key (“MENU” function).
- To select the sub-menus, scroll UP or DOWN the list using the   arrow keys, then confirm your choice pressing the  key (“ENT” function).
- To exit and get back to the main screen press the  key (“ESC” function).

MENU
Wpt Near Airfield
Wpt Nearest
Wpt Competition
Wpt User
Routes
Altimeters
Logbook
AirTools
Main Setup
Advanced Setup
Variometer Setup
Telemetry BT







2.6.1 STANDARD FIELDS EDITING

- To change parameters and settings, select the parameter you want to change by scrolling UP or DOWN using the   keys, press the  key (“EDIT” function) to enter in the edit mode.
- To change the value of the selected parameter, use the   keys to select the new value, each parameter’s change is automatically saved (“AUTOSAVE” function) when you exit; keeping the ,  keys pressed

activates the quick parameter change (“AUTOREPEAT”) function.

- To exit from the edit function, press the  key (“ESC” function).

2.6.2 ALPHANUMERICAL FIELDS EDITING





- Changing the alphanumeric fields is different from the normal editing described above, because it is possible to modify every single character of the field.
- To modify the field, press the  key (“EDIT” function) that activates the edit mode.
- Use the arrow keys   to change the character shown in reverse mode on the display. Each parameter’s change is automatically saved (“AUTOSAVE” function) when you exit; a longer pressure/touch of the arrow keys activates the quick parameter change (“AUTOREPEAT”) function.
- By pressing the  key, you will shift to the character on the right and edit it; by pressing the  key repeatedly you will scroll towards the right through all the individual fields until you go back to the first one. A longer pressure/touch of the  key moves back to the left; to exit press the  key.

2.7 MULTI LANGUAGE HELP



- “Help” texts are available in the setup menus to guide you through the parameters. It is possible to set the preferred language for these texts on the MAIN SETUP menu (**MAIN SETUP \ n. 2 LANG**) by selecting the preferred language. The change will be automatically saved when you exit.

Important: after every firmware update, it is necessary to update the help file containing the help messages as well. The help file update can be performed from your PC/Mac using Digifly AirTools, function: “upload HELP”.

2.8 RESTORE FACTORY SETTINGS











- To restore the factory settings (default values for all parameters), turn your instrument on by pressing and holding down the keys  & , at the same time, until the message “FACTORY SET?” appears. To confirm press  or press the  key to cancel/abort.

2.9 RESET

- If a system crash occurs (resulting in the instrument freezing), it is possible to reset its functions by pressing the  and  keys holding them down, at the same time, for more than 5 seconds.

3 QUICK REFERENCE GUIDE

3.1 SYMBOLS

	Battery level
	Bluetooth activated
	Static icon = GPS FIX valid (GPS position available) Blinking icon = low GPS signal (GPS position NOT available)
	Flight recorder on
	Volume level
	Direction towards the center of the current Waypoint
	Direction towards the optimized point of the current WP's cylinder
	Direction towards the optimized point of the current WP's cylinder
	Last thermal position
	Wind direction (from where it is coming)



3.2 PAGES

- The Digifly AIR features 13 pages: 12 configurable pages and one main page with GPS info, called the “**MASTER INFO GPS PAGE**” which, for safety reasons, cannot be changed or disabled.

3.2.1 CONFIGURABLE PAGES

- There are 12 configurable pages; each one is linked to one of the 12 configurable parameters (from **MAIN SETUP\ n. 26 PGO1** to **MAIN SETUP\ n. 37 PG12**) and for each page it is possible to configure a different layout:
OFF = the layout view of the page is disabled (the page will be skipped)
STD = it will show the corresponding Digifly standard layout
USR = it will show the corresponding user layout created and uploaded by the user using the **free** Digifly program **AirPages** (for more details about software usage refer to chapter 14.1.2).

3.2.2 MANUAL PAGE SWITCHING

- To manually change the pages, press the  key to go forward or the  key to go back. You can manually switch pages even if you are in “Intellifly” mode.

3.2.3 AUTOMATIC PAGE SWITCHING (INTELLIFLY)

- The automatic page-switching among the different pages is automatically managed by the **Intellifly** system, which recognizes the type of in-flight situation you are in at all times.
- Each type of in-flight situation is associated to a different set of pages (2 per set):
Pages 1 and 2 are associated to a “Competition flying while navigating towards a standard waypoint” situation.;
Pages 3 and 4 are associated to a “Competition flying while navigating towards a Start waypoint”;
Pages 5 and 6 are associated to a “Competition flying while navigating towards a Goal waypoint”;
Pages 7 and 8 are associated to a “Free Cross Country flying” situation;
- Each set of pages is formed by a “THERMAL” and a “GLIDE” version. The automatic page switching within each set of pages follows these criteria: It will switch to the “THERMAL” page when it notices a thermal that lasts longer than the value set on the **VARIOMETER SETUP/ n.17 THET** parameter (default setting 2 seconds) and you make a turn to fly into it; it will switch to the “GLIDE” page when you fly “straight” for a period of time, longer than the value set on the **VARIOMETER SETUP \ n.16 CRUT** (default setting 15 seconds).
- The **MAIN SETUP\ n. 38 IFLY** parameter sets the mode in which the Intellifly system will work :
- **IFLY=OFF**: automatic page switching is disabled.
- **IFLY=CMP**: automatic page switching is in “Competition” mode:
when your current wpt is a standard one, it will automatically switch between PGO1 and PG02;
when your current wpt is the START, it will automatically switch between PG03 and PG04;
when your current wpt is the one before last on your route (GOAL), it will automatically switch between PG05 and PG06.

If I manually switch to a page outside the PG01-PG06 range, while on IFLY = CMP mode, the automatic switching will be paused until I manually switch back to one of the pages of the PG01-PG06 range.
Remember to verify that all 6 competition pages are active: **MAIN SETUP\ n.26 PG01** to **MAIN SETUP\ n.31 PG06 = STD** or **USR** (in case you have uploaded your own pages).

- **IFLY=XC**: automatic page switching will be on “Cross Country” mode (default setting): it will automatically switch between PG07 e PG08.

PG07 is the XC – Thermal page and PG08 is the XC – Glide page.

If I manually switch to a page different from PG07 or PG08, the automatic page switching mode will be paused until I manually switch back to a page among PG07 or PG08.

Remember to check that the 2 Cross Country pages are active: **MAIN SETUP\ n.32 PG07** and **MAIN SETUP\ n.33 PG08** on **STD** or **USR** (in case you have uploaded your own pages).

3.3 COMPETITION PAGES

- Pages 1-6 are designed for competition flying:
 - pages 1 and 2 provide information regarding navigation towards a standard waypoint;
 - pages 3 and 4 provide information regarding navigation towards the START;
 - pages 5 and 6 provide information regarding navigation to the final waypoint (GOAL);
- N.B. Pages 1 to 6 are disabled by default, in order to activate them, you must set their 6 parameters (**MAIN SETUP\ n. 26 PG01** to **MAIN SETUP\ n. 31 PG06**) to **STD** (to display the standard page your Digifly comes with) or on **USR** (to display the custom pages called “USER” previously uploaded to the Digifly using our free software **AirPages**).

3.3.1 PAGE 1 COMP FLIGHT (THERMAL) AND PAGE 2 COMP FLIGHT (GLIDE)

- Pages 1 and 2 provide information regarding navigation toward a standard waypoint:
 - your current waypoint’s name
 - flight direction towards the optimized point of the current waypoint’s cylinder(**FOLLOW ME**)
 - required glide to reach the optimized point of your current waypoint’s cylinder
 - shortest distance to the current’s waypoint cylinder (**D0**)
 - distance to the optimized point of the current waypoint’s cylinder (**D1**)
 - expected height of arrival to the optimized point of the current waypoint’s cylinder (**H1**)
 - Cross Track error regarding the route connecting the centers of the waypoint cylinders (**XT**)
- When the instrument recognizes a thermal and you make a turn to fly into it, the automatic page switching feature will take you to PG01 **COMP FLIGHT (THERMAL)**, which besides the navigation info will also display the information regarding the thermal itself: **Thermal Assist** will help you center the thermal’s core better, (**DT**) will show you the distance to the thermal’s core and the **A3 Altimeter** which will show you the altitude difference as you thermal and will automatically reset (go to zero) when you enter the thermal.
- When flying “on a straight line” for a period of time greater to the value set in the **VARIOMETER SETUP\ n. 16 CRUT** parameter (default 15sec) the instrument will automatically switch to PG02 **COMP FLIGHT (GLIDE)**

PAGE 1 COMP FLIGHT (THERMAL)



PAGE 2 COMP FLIGHT (GLIDE)

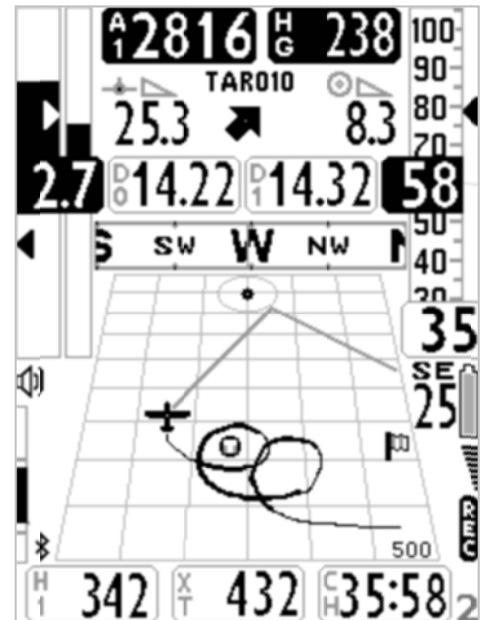

3.3.2 PAGE 3 COMP START (THERMAL) AND PAGE 4 COMP START (GLIDE)

- Pages 3 and 4 provide information regarding the navigation towards the START Waypoint of your route:
 - Current waypoint's name
 - Flight direction towards the optimized point of the current waypoint's cylinder (**FOLLOW ME**)
 - Required glide ration to reach the optimized point on the current waypoint's cylinder
 - Required speed to reach to the Start line (cylinder) exactly a the Start Gate's opening time (**SS**)
 - Shortest distance to the nearest point on the current waypoint's cylinder (**D0**)
 - Distance to the optimized point on the current waypoint's cylinder (**D1**)
 - Current time (**RT**)
 - Time remaining (countdown) to the Start Gate opening time (**CS**)
 - Approximate time of arrival to the cylinder line of the Start waypoint I (**ES**)
- When the Digifly recognizes a thermal and you make a turn to fly into it, the Digifly will automatically switch to PG03 (**THERMAL**), which besides the navigation information, will also display the **Thermal Assist** instrument for thermal core centering.
- When you fly "on a straight line for a period of time greater than the value set on the **VARIOMETER SETUP\ n. 16 CRUT parameter** (default 15sec), the instrument will automatically switch to PG04 **COMP START (GLIDE)**

PAGE 3 COMP START THERMAL

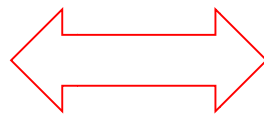
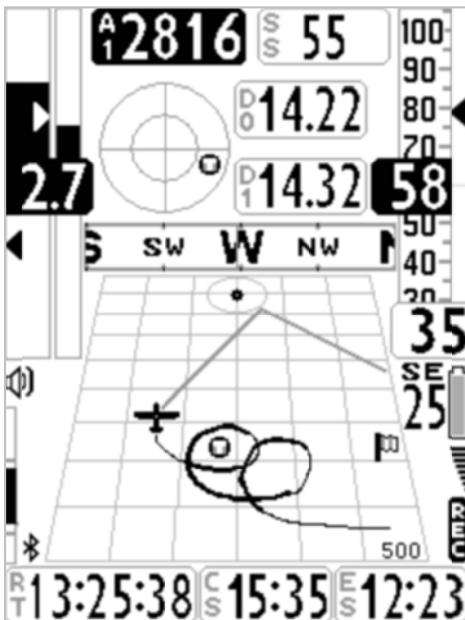

PAGE 4 COMP START GLIDE

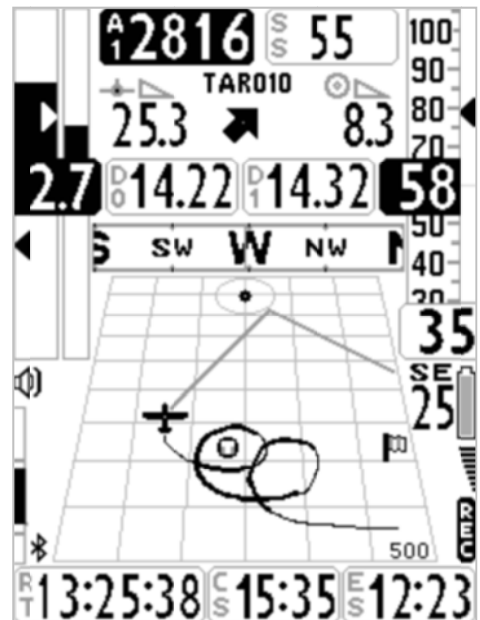

3.3.3 PAGE 5 COMP GOAL (THERMAL) AND PAGE 6 COMP GOAL (GLIDE)

- Pages 5 and 6 provide information regarding navigation towards the arrival waypoint (GOAL) of your route:
 - Current waypoint's name
 - Flight direction towards the optimized point of the current waypoint's cylinder (**FOLLOW ME**)
 - Required glide ration to reach the optimized point on the current waypoint's cylinder
 - Shortest distance to the nearest point on the current waypoint's cylinder (**D0**)
 - Distance to the optimized point on the current waypoint's cylinder (**D1**)
 - Required glide to reach the cylinder of the route's last waypoint (GOAL)
 - Estimated arrival height over the cylinder of the route's last waypoint (GOAL) (**HA**)
 - Distance to the cylinder of the route's last waypoint (GOAL) (**DA**)
- When the Digifly recognizes a thermal and you make a turn to fly into it, the Digifly will automatically switch to PG05 **PAGINA 5 COMP GOAL (THERMAL)**, which besides the navigation information, will also display the instruments for thermal flying: **Thermal Assist** will help you center the thermal's core better, (DT) will show you the distance to the thermal's core and the A3 Altimeter which will show you the altitude difference as you thermal and will automatically reset (go to zero) when you enter the thermal.
- When you fly "on a straight line for a period of time greater than the value set on the **VARIOMETER SETUP\ n. 16 CRUT** parameter (default 15sec) the instrument will automatically switch to PG06COMP GOAL (GLIDE)

PAGE 5 COMP GOAL THERMAL



PAGE 6 COMP GOAL GLIDE

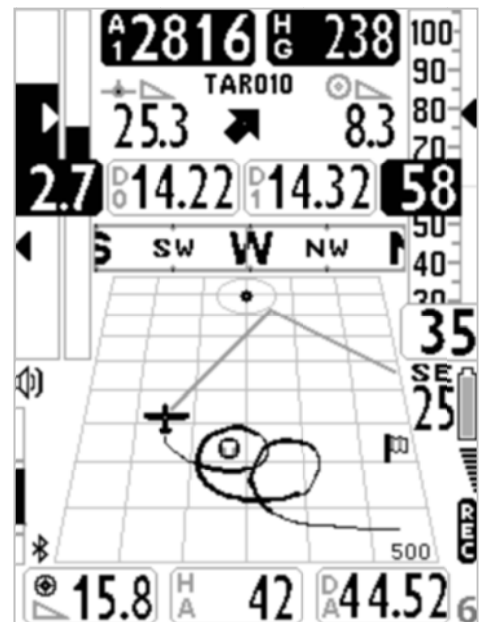

3.4 CROSS COUNTRY (XC) PAGES

- Pages 7 and 8 provide information regarding navigation during Cross Country (XC) flying and provides information regarding navigation towards the active waypoint:
 - Active waypoint's name
 - Flight direction to reach the active waypoint
 - Required glide to reach the active waypoint's cylinder
 - Distance to the active waypoint (**D1**)
 - Estimated height at arrival to the active waypoint's cylinder (**H1**)
- When the Digifly recognizes a thermal and you make a turn to fly into it, the Digifly will automatically switch to PG07XC (**THERMAL**), which besides the navigation information, will also display the instruments for thermal flying: **Thermal Assist** will help you center the thermal's core better and (DT) will show you the distance to the thermal's core.
- When you fly "on a straight line for a period of time greater than the value set on the **VARIOMETER SETUP\ n. 16 CRUT parameter** (default 15sec) the instrument will automatically switch to PAGE08 XC (**GLIDE**)

PAGE 7 XC (THERMAL)



PAGE 8 XC (GLIDE)

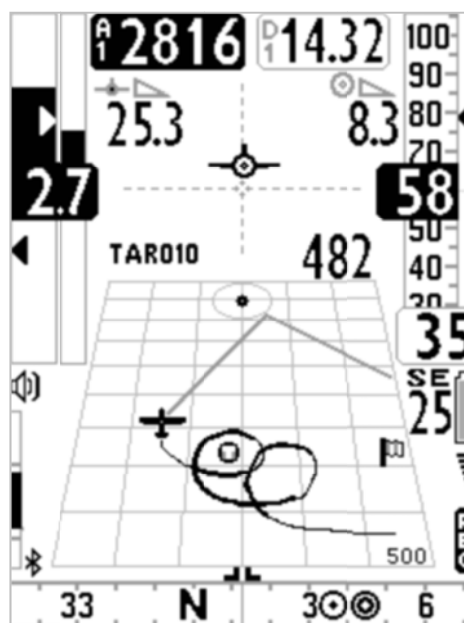

3.4.1 PAGE 7 XC (THERMAL)

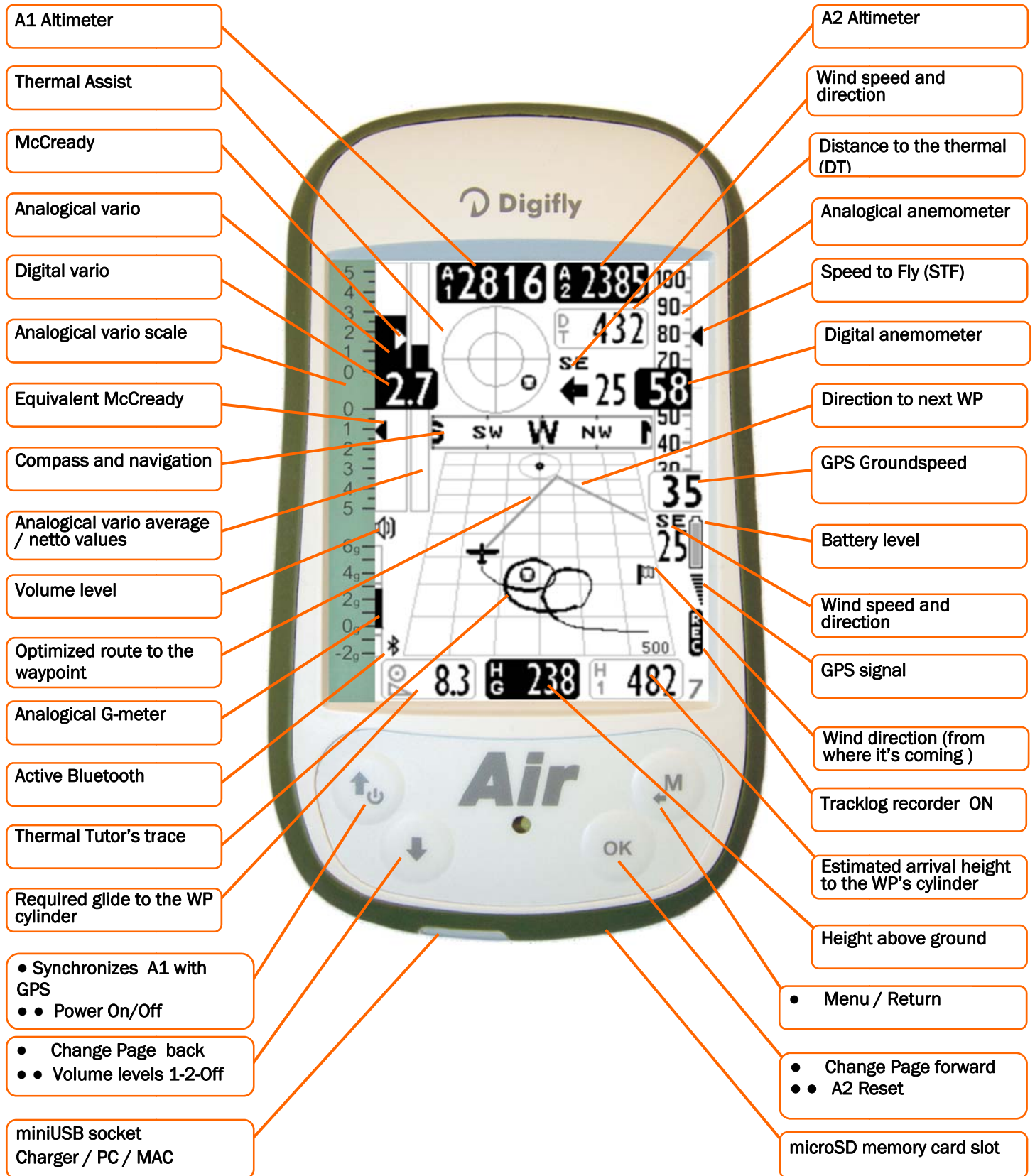

● = Normal ●● = LONG press (2 seconds)

3.4.2 PAGE 8 XC (GLIDE)

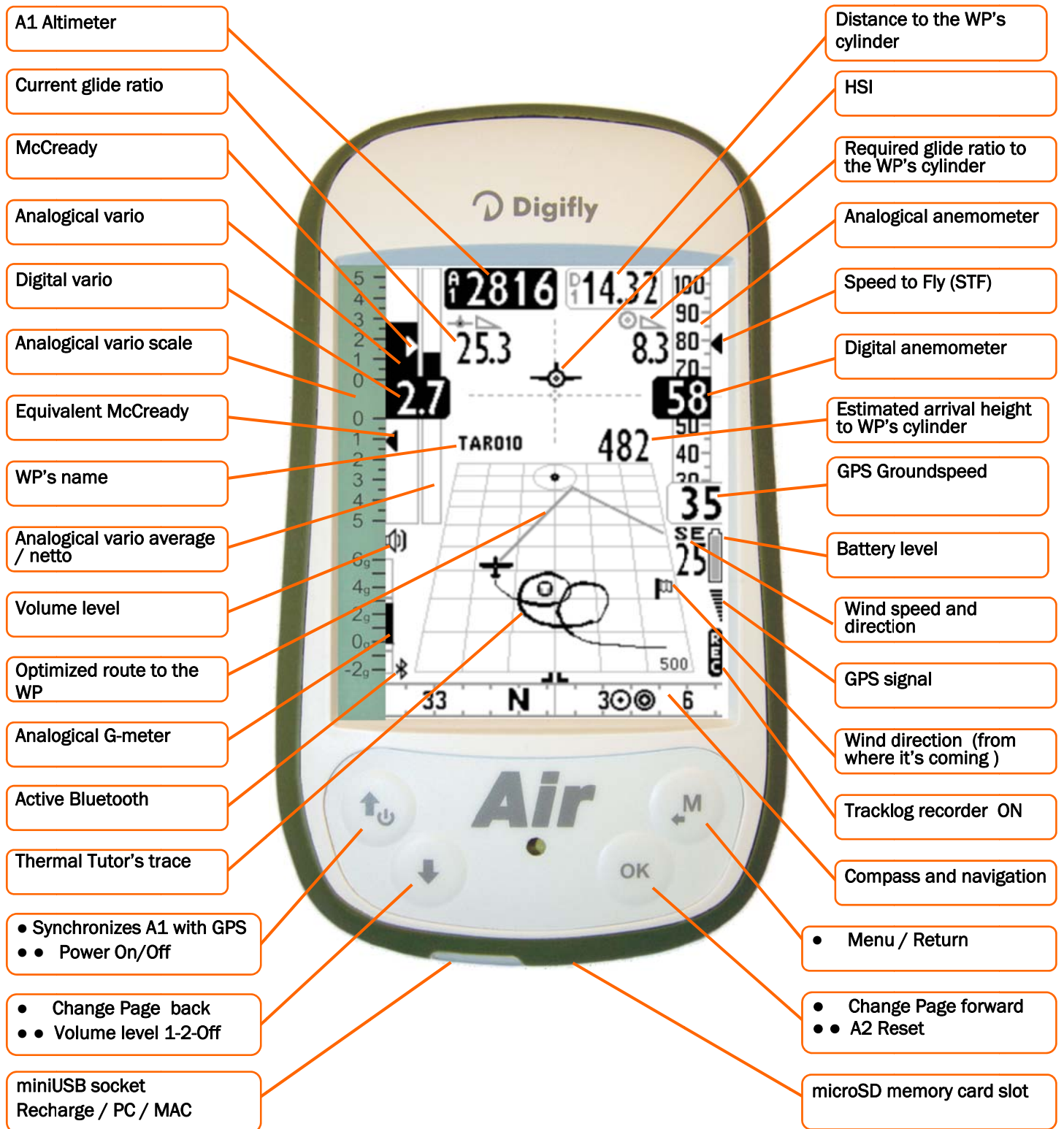

• = Normal press •• = LONG press (2 seconds)

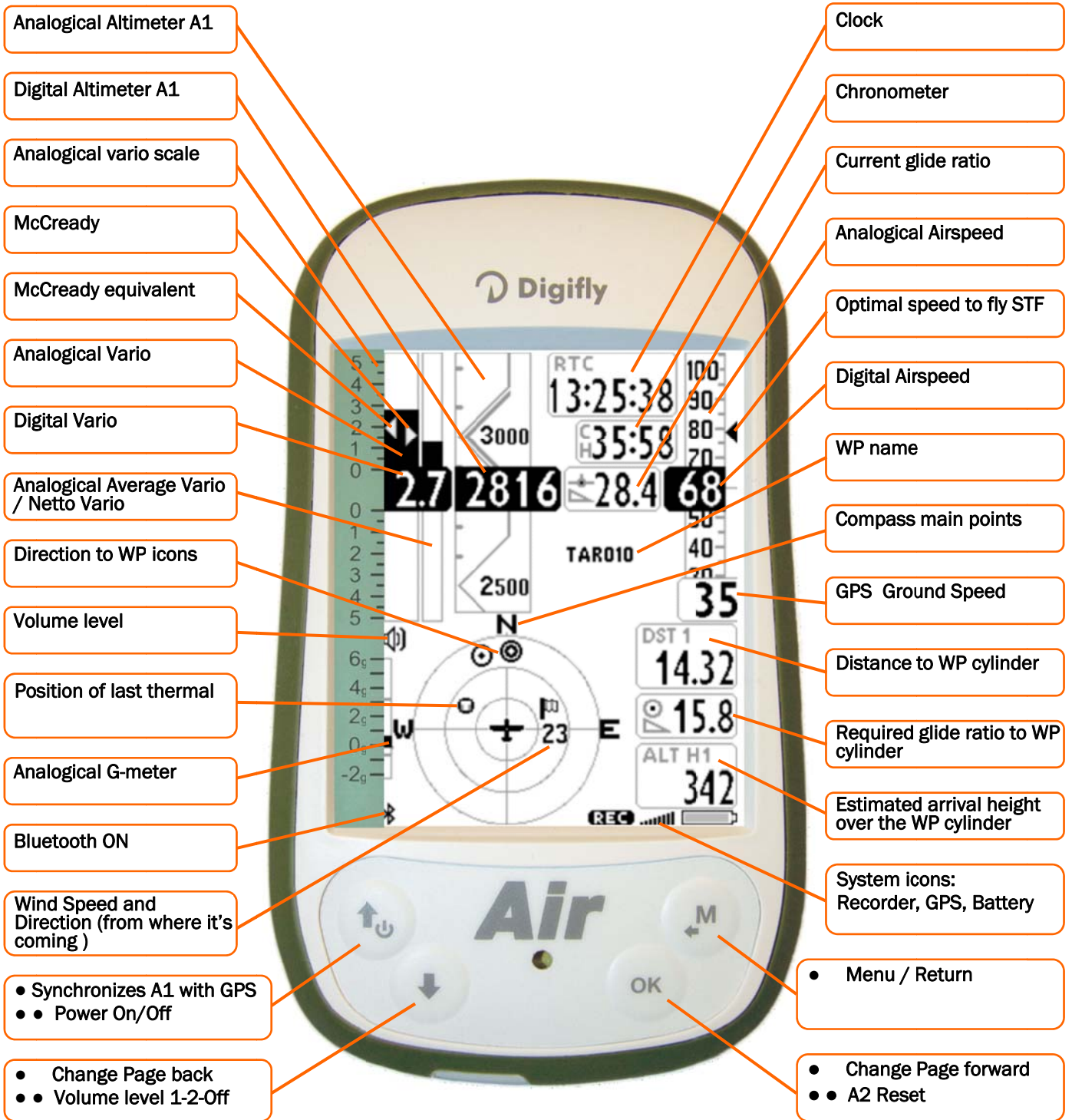

• = Normal key pressure •• = Long key pressure (2 seconds)

3.6 PAGE 10 RELAX

- Page 10 "RELAX" displays the most important information in very LARGE font size: A1 barometric altimeter, Variometer , A2 barometric altimeter.



3.7 PAGE 11 AHRS

- Page 11 "AHRS" displays, from top to bottom, the following parameters:
- Polar data (if the Polar is enabled)
- Airspeed
- G-meter
- Pitch
- Roll
- Yaw
- Magnetic compass
- Battery level

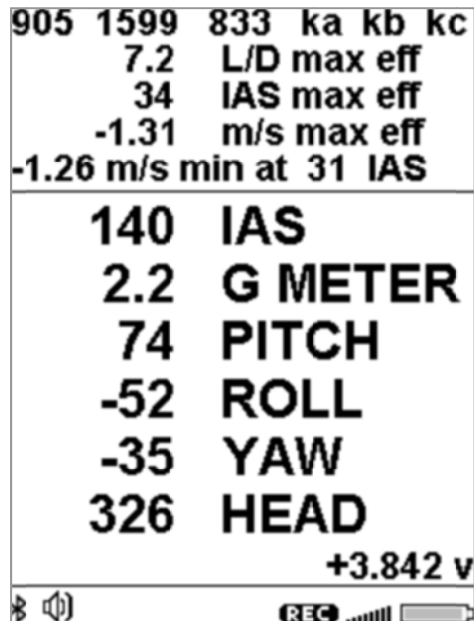

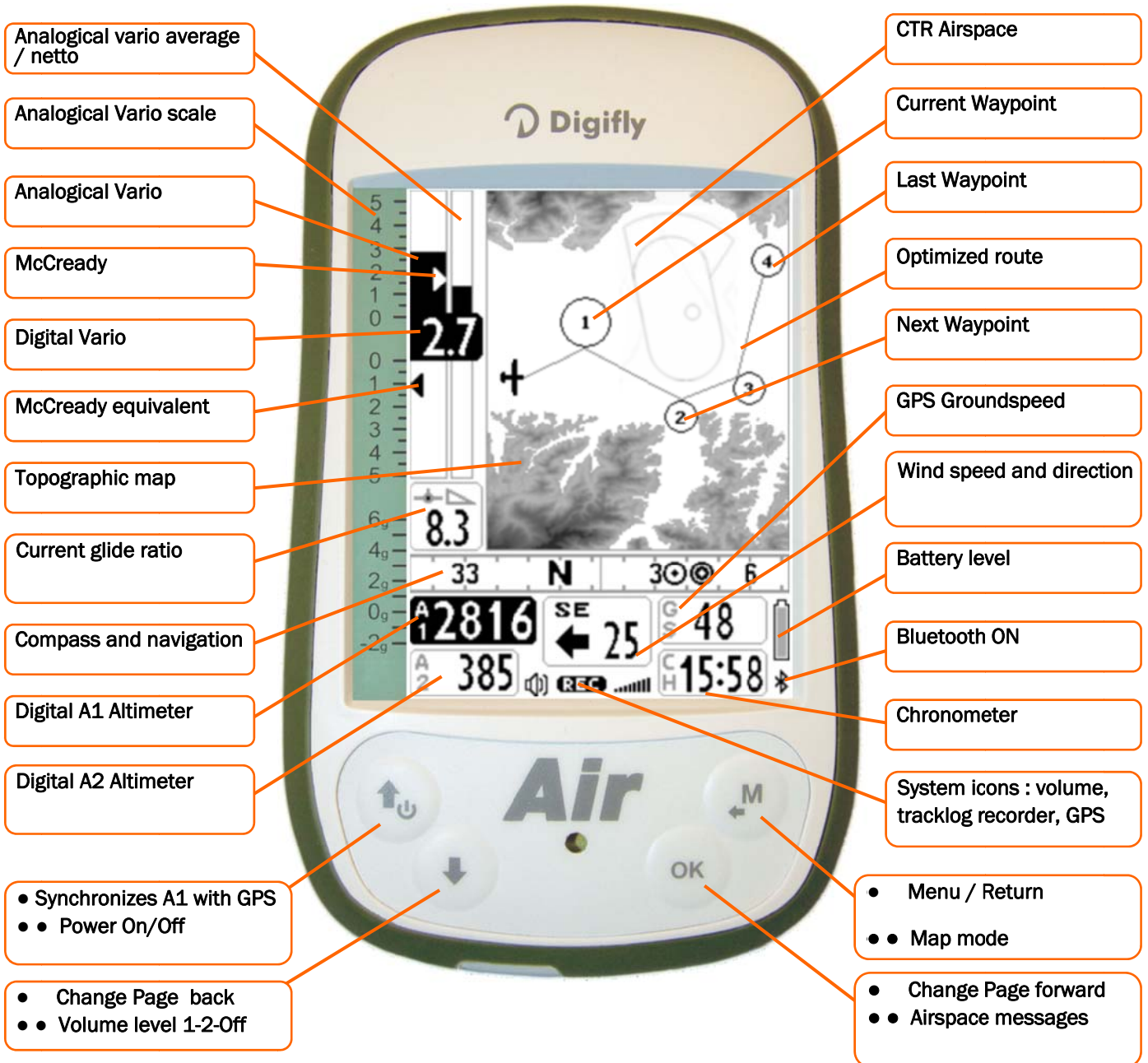

• = Normal •• = LONG press (2 seconds)

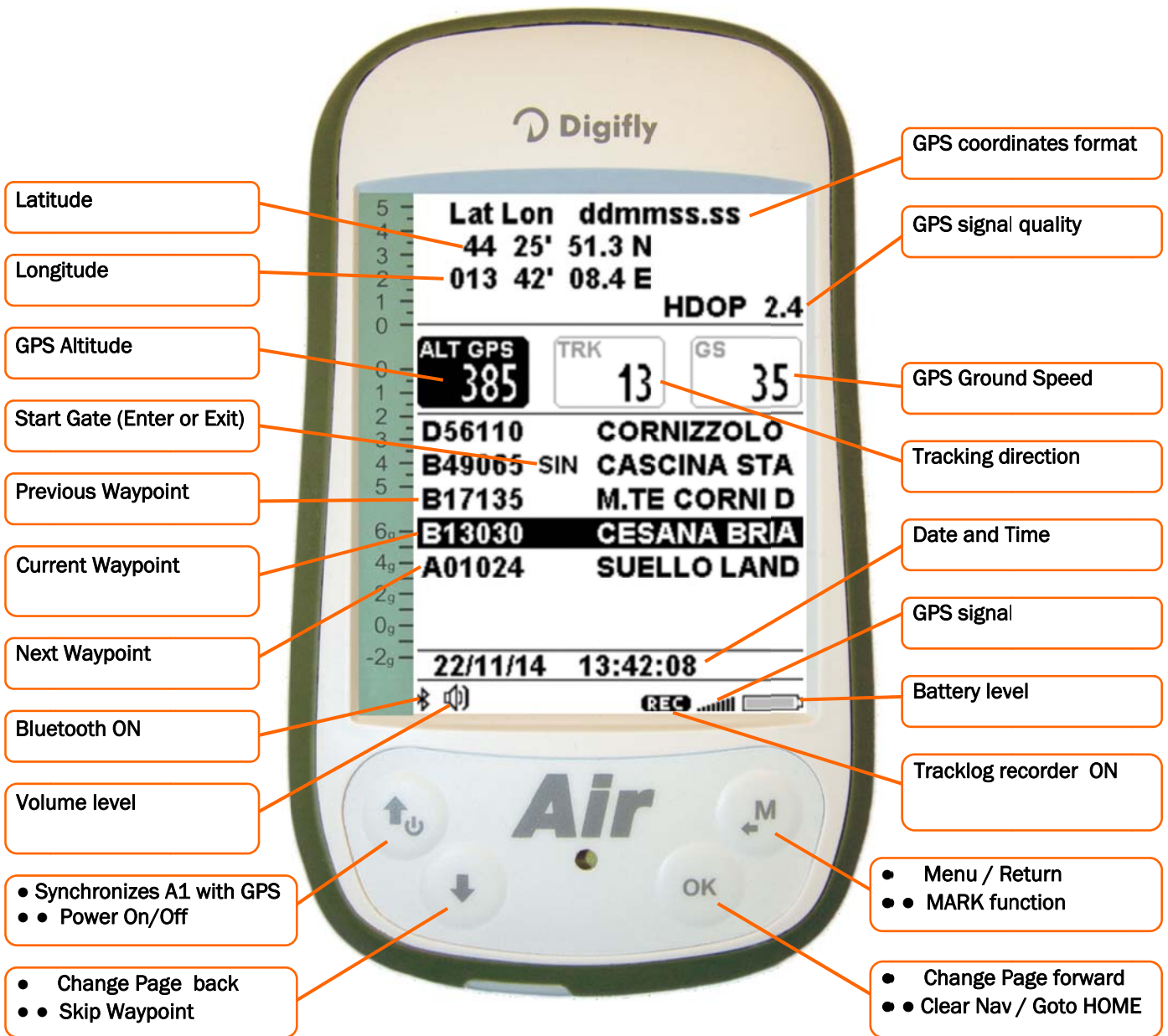

● = Normal key pressure ●● = Long key pressure (2 seconds)

On the MASTER INFO GPS page, all values relative to your GPS position and navigation are visible. While on this page only, you can access the following particular functions: “take me here” (GOTO HOME), “save current position” (MARK), “cancel current navigation” (CLEAR NAV), real time navigation supervision "**Real Time Navigation Manager**" of active route and “**Skip Waypoint**” through WPT.

3.9.1 GPS STATUS INFORMATION

- The GPS icon signal has different meanings:
 - Static GPS icon = Correct GPS FIX (GPS position available) 
 - Blinking GPS icon = poor GPS signal (GPS position NOT AVAILABLE)

3.9.2 LATITUDE & LONGITUDE COORDINATES

- The latitude and longitude coordinates are shown on the top of the INFO GPS page and are referenced to map datum WGS84.

3.9.3 LATITUDE & LONGITUDE COORDINATES OPTIONS

- There are available 4 different coordinate formats to choose from:
 - DMS** = degrees, minutes and seconds (dd° mm' ss.s) - default
 - DMM** = degrees and minutes (dd° mm.mmm')
 - UTM** = Universal Transverse Mercator (utm x, y, zona).
 - DDD** = decimal degrees (dd.ddddd)

To set the preferred DMM, DMS, UTM or DDD formats, go to MENU \ **ADVANCED SETUP** \ n. 23 **CORD**.

3.9.4 GPS SIGNAL QUALITY (HDOP)

- The HDOP value represents the weakening of GPS signal; lower values mean good precision.

3.9.5 GPS ALTITUDE

- GPS altitude (“ALT GPS”) represents the height over sea level given by the GPS system.

3.9.6 GPS DIRECTION (TRK)

- GPS direction (“TRK”) represents the aircraft’s direction relative to the ground.

3.9.7 GPS GROUND SPEED

- The GPS ground speed is the aircraft’s speed relative to the ground (“Gs”).

3.9.8 REAL TIME NAVIGATION MANAGER / SKIP WAYPOINT

- The central part of the GPS INFO page shows the navigation progress of an active route in real time; you see the waypoint list of the active route, where the current waypoint is highlighted in "reverse" (white over black).
- The "**Skip Waypoint**" function allows to choose to navigate to the previous or next waypoint(s):

only from the **GPS INFO** page, with an active route, **LONG PRESS** the  button; menu will appear, press the

 button to jump to the previous Waypoint or press  to jump to the next Waypoint. Press  to cancel.

- The Digifly AIR also has a shortcut for the “Skip Waypoint” function, from any of the navigation pages. In order to

activate it, the "Skip Waypoint Shortcut" parameter (**ADVANCED SETUP \ n. 24 SKPW**) needs to be activated.



Keep in mind that this will change the functions of some buttons:

With the parameter set to **OFF** = Shortcut disabled (default), **LONG PRESSING** the "ARROW DOWN" button changes the volume level and **LONG PRESS** of the "OK" button sets the A2 altimeter to zero.

However, with the parameter set to **ON** = Shortcut enabled and, when a route is activated both for competition or XC, **LONG PRESSING** the "ARROW DOWN" and "OK" buttons, will respectively work as skipping a waypoint back and forward buttons, without having to go to the Info GPS page first.

3.9.9 CREATING A NEW WAYPOINT USING THE CURRENT POSITION (MARK)



- "MARK" function: when the GPS acquires a valid position, it is possible to save it in the instrument's memory.

From the **GPS INFO** page **LONG PRESS** the  key; the message " Save Mark ?" is shown, press the  key to confirm or the  key to cancel. The current position will be saved as a new Waypoint in the User Waypoint list ("WPT USER") with the format nnMaaa (aaa= altitude GPS in tens of meters)



3.9.10 NAVIGATION TO "HOME" WAYPOINT (GOTO HOME)

- Available only on the **GPS INFO** page, it ensures that the instrument guides us back to the point where we activated this function from.

It is particularly useful, for example, when we go flying to a new site of which we don't have any waypoints and we want to be guided to the official landing zone (LZ). In this case, it is necessary to go to the LZ and activate this function there.



- How to activate the "GOTO HOME" function: from the **GPS INFO** page, with valid GPS position, **LONG PRESS** the  key, the message " Activate Home Wpt ?" is shown, press the  key to confirm or  to cancel.

Note : if navigation has been previously activated, it is necessary to first deactivate it from the **GPS INFO** page

LONG PRESSING the  key, the message " Clear Nav ?" is shown, press the  key to confirm or  to cancel.

The "GOTO HOME" function creates a landing waypoint in the User Waypoint list ("WPT USER") with the current position data "HOMaaa" (aaa = GPS altitude in tens of meters) and with the icon "A" (Airfield), at the same time, it activates the navigation to it (GOTO).

3.9.11 DEACTIVATING THE CURRENT NAVIGATION (CLEAR NAV)

- **CLEAR NAV** function: to disable the active navigation, **LONG PRESS** button , the " Clear Nav ?" message will appear, confirm with the  button or press  to cancel.

3.9.12 DATE & TIME

- Date and current time are constantly updated automatically with GPS data.
- To set time zone you are in, go to: **MAIN SETUP \ n. 7 UTCO**.

4 MAIN FUNCTIONS

4.1 ALTIMETERS

- The Digifly AIR features 7 different altimeters: ALT 1, ALT 2, ALT 3, ALT H1, ALT HA, ALT GPS and ALT AGL.
 - ALT 1 (A1): Main barometric altimeter A1
 - ALT 2 (A2): General purposes barometric altimeter A2
 - ALT 3 (A3): Gain during the current thermal
 - ALT H1 (H1): Estimated height over the cylinder of the current WP
 - ALT HA (HA): Estimated height relative to goal cylinder, line, etc.
 - ALT GPS (AG): GPS Altimeter
 - ALT AGL (HG): Height above ground level

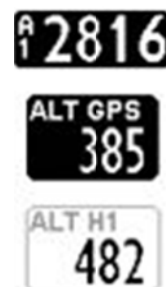

▪ AGL Altimeter

The **AGL** altimeter, shows the height above ground, (**AGL = Above Ground Level**).



In order to be able to see the **AGL** altimeter, you must have a microSD card with the *.dgm map files of the area you will be flying -created using AirTools- in your Digifly and that the “Elevation Mode” parameter (**MAIN SETUP \ n. 19 ELVM**), is set to either 1, 2 or 3. A detailed description on how to create a map and how to set the map parameters, go to “6.15.1 TERRAIN”.

- **Graphic Altimeter:** digital value of A1 altimeter is integrated with the graphic scrolling altimeter. With a friendly scale and numeric indications every 500 mt/ft embedded into an angular graphic view making the numbers more readable.

There is also a simple graduated scale for meters in the hundreds.



4.1.1 ALTIMETERS' SETTINGS

- Go to the “**ALTIMETERS**” menu and select which altimeter you want to adjust (A1 or A2).
Important: while the recorder is activated is not possible to adjust the A1 altimeter.
- Synchronizing the A1 with the altitude provided by GPS data:
If the “A1-GPS sync.” is enabled, (**MAIN SETUP \ n. 39 A1SY** default= ON), you are not moving (in flight) and have not manually set the A1 altimeter, this altimeter will automatically synchronize with the GPS data.
To manually synchronize the A1 altimeter with the altitude data from the GPS, press the  button. This may only be done when the instrument has acquired GPS coverage, if you are not moving and if the A1SY parameter is set to ON. Once the flight recorder has started, this synchronization is no longer possible.
- The **A2** altimeter is used for general purposes. To reset it **LONG PRESS** the  key. With the “Skip Waypoint” shortcut parameter activated (**ADVANCED SETUP \ n. 24 SKPW=ON**) the “OK” button will have a different function: it will take you to the next waypoint on your route and will no longer zero the A2 altimeter.
If the parameter (**MAIN SETUP \ n. 25 A2AU=ON**), the AIR will automatically set the Altimeter 2 to zero, right after launch.
- The **A3** altimeter is automatically reset when you start thermalling.
- The altimeters can be shown in meters (mt) or feet (ft), to set up, go to: **MAIN SETUP \ n. 13 U-AL**.

4.2 VARIOMETERS

4.2.1 10-SENSORS VARIOMETER WITH SELF-ADAPTIVE SENSITIVITY

- It's a revolutionary digital system designed by Digifly, based on a sophisticated data acquisition system updated 100 times each second that merges 10 sensors: the atmospheric pressure sensor data with the 9 sensors of the inertial data platform (3 accelerometers, 3 magnetometers and 3 gyroscopes).
- This system is also equipped with a **self-adaptive sensitivity** that auto-modulates the instruments sensitivity according to the air's situations: increasing it in weak conditions and decreasing it in strong conditions or turbulence.

This allows to have a vario with high sensitivity and instantaneous response, that is yet fluid and immune to the turbulences while very helpful in weak conditions thanks to its pre-thermal function. In contrast to the traditional ones, based on pressure sensors only, this vario is not affected by false readings due to acceleration.

Important Notes: *The mathematical method that manages the variometer has been optimized to obtain an excellent response during flights; for this reason, we suggest you try or compare it flying and not on the ground.*

- The vario reactivity can be set with **VARIOMETER SETUP \ n. 10 RVAR**, ranges from 1 (minimum reactivity) to 20 (maximum reactivity); default =10.

4.2.2 DIGITAL VARIO

- Shows instant climbing or descending values in a range of +/- 25 m/s in digital format +/- 5,000 fpm.

4.2.3 ANALOGICAL VARIO

- Indicates the instant vario values; it is displayed by the left-hand analogical bar indicator that shows the sink or climb rate within a +/- 5 m/s range, +/- 500 fpm range.

4.2.4 INTEGRATED (AVERAGE) VARIO

- The right-hand bar shows the integrated vario values; the average of the instant vario during X amount of time (this bar can be changed to the value of the net vario, see section. 4.2.6).
- It can be used to monitor the progression of your climb to see if it is getting better or worse. For example, if the integrated vario value is higher than the instant vario, it means that the climb was previously stronger; it can be used, therefore, to better core the thermal.
- The averaging time (integration time) can be set with **VARIOMETER SETUP \ n. 11 INTE**, ranging from 5 to 60 seconds.

4.2.5 NET VARIO (WITH OPTIONAL PITOT TUBE)

- The bar on the right hand, analogically indicates the climb/descent rate values of the air mass around you in a +/- 5m/s (approx. 1,000fpm) range. It can also be set to display the average vario values instead (see 4.2.6).
- When the netto vario is being displayed, the icon "NET" will show on the right-hand bar.
- **N.B.** In order to use this function, you must have a Digifly AIR with Pitot Tube option and that the tube is installed on the instrument; also, you need to have the Polar coefficients to be programmed in your instrument (for example, you have Polar 1: **ADVANCED SETUP \ n. 11-12-13 P1A-P1B-P1C**) and set the Polar parameter to use the values stored for Polar 1 (for example, Polar 1: **ADVANCED SETUP \ n. 10 POLA=1**).



4.2.6 INTEGRATED VARIO / NET VARIO AUTOMATIC SWITCH

- You can change the vario's indicators layout using **VARIOMETER SETUP \ n. 12 DSEL** :
 - 0 = (default), the right-side analog bar always shows the average vario and the digital indicator always shows the instant vario.
 - 1 = right-side analog bar and digital indicator always show average vario values.
 - 2 = right-side analog bar and digital indicator always show net vario values.
 - 3 = right-side analog bar and digital indicator change depending on effective flight conditions: when you are gliding, the right-side analog bar and the digital indicator both show net values and, when you are thermalling, the right-side analog bar shows the average vario values and the digital indicator shows the instant vario values.
 - 4 = right-side analog bar and digital indicator change depending on effective flight conditions: when you are gliding the right-side analog bar and the digital indicator both show net values, when you are thermalling, the right-side analog bar and the digital indicator both show average vario values.
- When the net vario value is shown, the "NET" icon will appear vertically on the right bar.
- Thermalling mode / Gliding mode:** it switches to "Thermalling" mode when it feels a new thermal for more than x seconds (**VARIOMETER SETUP \ n. 17 THET**) default 2 seconds and you make a turn to fly into it; it switches to "Gliding" mode when you fly "straight" for more than x seconds defined in **VARIOMETER SETUP \ n. 16 CRUT**); default =15 seconds.



4.2.7 McCREADY (WITH OPTIONAL PITOT TUBE)

- The McCready value is the average lift value of the last "nn" minutes in thermal
- To adjust the average lift time: **ADVANCED SETUP \ n. 20 MCRA**. (default: 10min)
- N.B.** In order to be able to use this function, you must have the Digifly AIR with Pitot Tube and have the tube installed in your instrument; also you need to have the Polar data programmed (for example, Polar 1: **ADVANCED SETUP \ n. 11-12-13 P1A-P1B-P1C**) and that the Polar parameter itself is enabled to work with the values you have programmed (for example, Polar 1: **ADVANCED SETUP \ n. 10 POLA=1**).

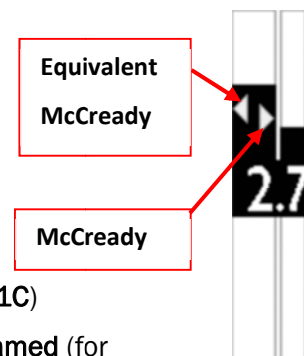

4.2.8 EQUIVALENT McCREADY (WITH OPTIONAL PITOT TUBE)

- This value indicates the Equivalent McCready value: this is the McCready value, considering the current airspeed as the optimal speed.
- The equivalent McCready, based on the glider's polar, the sink rate and the current airspeed (IAS), indicates in real time at which true McCready value we are flying compared to the optimal speed. When this value matches the one estimated in the thermal, this means that the current airspeed (IAS) matches the optimal speed (see "Speed to Fly" paragraph 4.5).
- To set the reaction time of the Equivalent McCready indicator go to: **ADVANCED SETUP \ n. 21 MCRE**.
- N.B.** In order to be able to use this function, you must have the Digifly AIR with Pitot Tube and have the tube installed in your instrument; also you need to have the Polar data programmed (for example, Polar 1: **ADVANCED SETUP \ n. 11-12-13 P1A-P1B-P1C**) and that the Polar parameter itself is enabled to work with the values you have programmed (for example, Polar 1: **ADVANCED SETUP \ n. 10 POLA=1**).

4.2.9 TOTAL ENERGY COMPENSATION (WITH OPTIONAL PITOT TUBE)

- To use this function, it is necessary to have the optional Pitot tube installed.

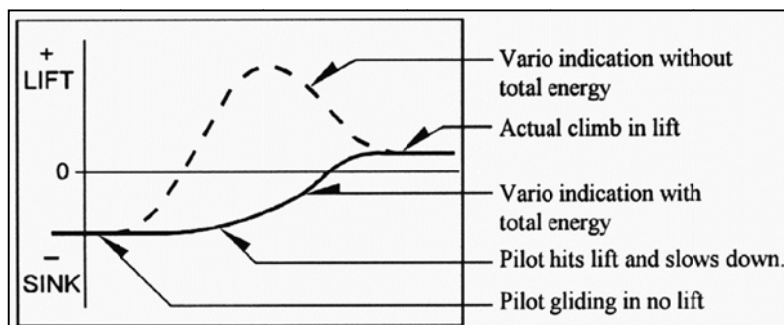

- Generally, a variometer works as follows: it feels the atmospheric pressure change rate considering it as an altitude change, but, if during the flight the pilot slows the glider (and even more so if done quickly), there is a real change of pressure, so a vario 'without compensation' records it as a climb, but this variation is caused by a change of speed (kinetic energy) and not due to a true thermal.
- With the Total Energy Compensation function, the part of the climb due to the change in velocity is ignored, allowing you to identify the "real" thermals.
- To properly set the TOTAL ENERGY compensation values, you need to set the following parameters:
 - "Total Energy Compensation Mode" (**VARIOMETER SETUP \ n. 13 TECM**): OFF = T.E.C. off (default), ON = T.E.C. is calculated during glide only, FUL= T.E.C. is calculated both during glide and in thermals.
 - "Total Energy Compensation" (**VARIOMETER SETUP \ n. 14 TEC**), to set this percentage correctly, you should fly in calm air conditions and slow down as if you were entering a thermal. If the vario shows a change in lift, you have to increase the total energy compensation value, until the change in velocity is no longer recorded as lift; a typical value for hang gliders is 65.
 - "Total Energy Compensation Average" (**VARIOMETER SETUP \ n. 15 TECA**): it is the average applied to the total energy component, the range goes from 0 (fast) to 99 (slow); default 80.

4.2.10 ACOUSTIC VARIO

- The acoustic vario represents the instantaneous values of the vario with a modulated acoustic tone.
- **LONG PRESSING** the  key while on any page (except Info GPS) changes the vario volume (3 settings): “HIGH”, “OFF” & “LOW”.

The chosen volume is shown by the ‘loudspeaker’ icon on the bottom left side of the display.

Please note that if the SKPW (ADVANCED SETUP \ n. 24 SKPW) parameter is ON, the function of **LONG PRESSING** the “arrow down” button, while flying with an active route will skip to the next waypoint and not adjust the volume; therefore, make sure you set the volume level before activating the route.



Remember that when you turn your Digifly AIR on, it checks the volume of the acoustic vario and, if it happens to be turned off, it will immediately turn it up to HIGH.

- To set the sound’s threshold level to indicate lift, go to: **VARIOMETER SETUP \ n. 1 V.UP**; for the sink’s threshold, go to: **VARIOMETER SETUP \ n. 3 V.DN**.
- It is possible to set the preferred acoustic profile with the **VARIOMETER SETUP \ n. 4 PROF** parameter. Three pre-set profiles are available (**FAS, STD, SFT**) plus two fully customizable ones (**USR1, USR2** - using AirTools); moreover, there is a manual ‘**MAN**’ mode, to directly customize the instrument using the following parameters:
 - **Style** (**VARIOMETER SETUP \ n. 5 STYL**): the relation between sound/pause; values from 1 to 3.
 - **Modulation** (**VARIOMETER SETUP \ n. 6 MODH**): increases the tone frequency; values from 1 to 30.
 - **Pitch** (**VARIOMETER SETUP \ n. 7 PITC**): increases the ascending **tones’ rhythm**; values from 1 to 4.
 - **Climb** (**VARIOMETER SETUP \ n. 8 UPHZ**): climb’s threshold tone’s frequency.
 - **Sink** (**VARIOMETER SETUP \ n. 9 DWHZ**) sink’s threshold tone’s frequency.
 - **Auto-silence** (**VARIOMETER SETUP \ n. 21 AUTV**): “ON” by default, it activates the acoustic vario only after takeoff and stops it 60 seconds after landing (see 4.2.11 for the “FUL” setting).

4.2.11 ACOUSTIC VARIO PRE-THERMAL TONE

- If activated, an acoustic signal with a tone and modulation significantly different of the acoustic vario, indicates that we are near a thermal (the instantaneous sink rate is better of the glider’s minimum sink rate, therefore indicating an area of slightly climbing air). To set the pre-thermal sound’s threshold go to: **VARIOMETER SETUP \ n. 2 V.PT**; value from 0,00 to 1,50 m/s and the suggested value is 0,50 m/s.
- Pre-thermal tone starts at -0,1 m/s and lower.
- If the parameter **VARIOMETER SETUP \ n. 21 AUTV = FUL** means the pre-thermal tone is only activated during glide and the acoustic vario will activate right after takeoff.

4.2.12 VARIO SIMULATOR

- For a perfect tuning of the acoustic vario, without flying, it is possible to set the ‘Vario Simulator’ mode, setting the **VARIOMETER SETUP \ n. 20 SIMV** parameter to “ON” and **VARIOMETER SETUP \ n. 21 AUTV** to “OFF”. Then exit from menu and use the arrow keys   to set the vario value.

To deactivate the simulator set **SIMV** to “OFF” and **AUTV** back to “ON” or “FUL”.

Note: for safety reasons the simulator is automatically deactivated when the instrument power on.

4.3 AIRSPEED (WITH OPTIONAL PITOT TUBE)

- This sensor measures the glider's airspeed; without it the AIR will only display Ground Speed values.
- This function is available only with the Pitot tube sensor module (optional). The tube will have to be inserted in the specific housing hole located on the instrument's top and the parameter **ADVANCED SETUP \ n.1 PITO** has to be set on the desired value: **IAS (Indicated Airspeed)** or **TAS (True Airspeed)**.
- It is possible to set the speed's unit of measure to km/h or mph using the parameter **MAIN SETUP \ n. 14 U-SP**
- The minimum speed indication is 18 km/h, 11 mph.



4.3.1 AIRSPEED CALIBRATION (WITH OPTIONAL PITOT TUBE)

- **Pitot tube sensor offset calibration**

It is possible to rectify the Pitot tube sensor offset using the **ADVANCED SETUP \ n. 3 OFSP** parameter:

Turn the instrument on, in a place where you don't have any wind (preferably indoors).

Write down the value of the sensor's number visible on PAGE 11 (AHRS) beside the km IAS indicator.

Go to "Advanced Setup" and use this number to set the **OFSP** parameter.

Warning: If used incorrectly, this feature will render your airspeed indicator less accurate.

- **Pitot tube sensor span calibration**

It is possible to perform a fine tuning of the airspeed full scale value using the **ADVANCED SETUP \ n. 4 KIAS** parameter that indicates the airspeed correction value (100%=no correction, 110%=increase, 90%=decrease).

Warning: If used incorrectly, this feature will render your airspeed indicator less accurate.

4.4 SPEED DIFFERENCE (WITH PITOT TUBE)

- The "Speed Difference Enable" (**ADVANCED SETUP \ n. 2 SDIF**) parameter = ON will display the headwind component (Ground Speed - Anemometric Speed), on the digital indicator on the bottom of the combined speed instrument, instead of showing the Ground Speed value.
A negative value ("-" symbol) indicates headwind.



4.5 SPEED TO FLY (WITH OPTIONAL PITOT TUBE)

- Speed to Fly (STF) is the best anemometric speed to obtain the best glide ratio; this value depends on performance of your glider as well as vertical and horizontal airflow. In calm air, the optimum flying speed is the same as the best glide speed (point **B**).

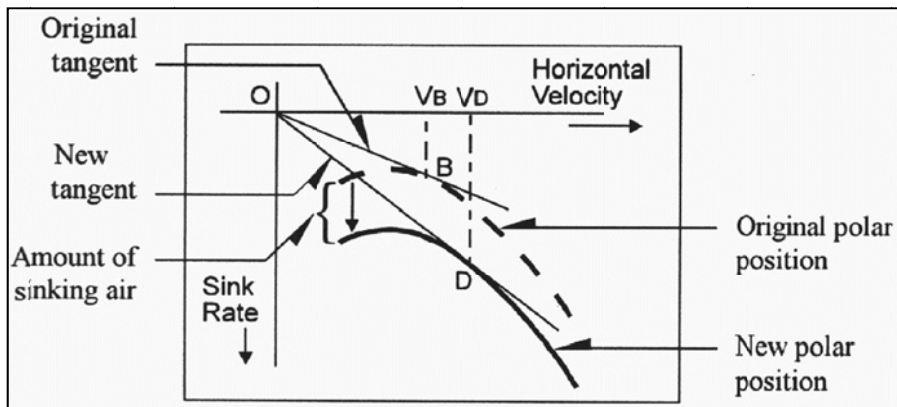

- The diagram shows different values of speed to fly related to different flight conditions
- The X-axis shows horizontal speed; the Y-axis shows sink rate. With headwind or sink conditions, the best glide speed increases. In order to find the optimum speed to fly value in sink conditions, the sink rate of the air is added to the polar of your glider, drawing a new polar and a new tangent line from the initial point of axes. The new tangent (point **D**) meets the polar at the point giving a higher optimum flying speed V_D .
- To fly at the correct “STF”, adjust your flying speed “IAS” to match the STF indicator (triangle symbol) with the value on the optimal anemometric speed.
- N.B.** In order to be able to use this function, you must have the Digifly AIR with Pitot Tube and have the tube installed in your instrument; also you need to have the Polar data programmed (for example, Polar 1: **ADVANCED SETUP \ n. 11-12-13 P1A-P1B-P1C**) and that the Polar parameter itself is enabled to work with the values you have programmed (for example, Polar 1: **ADVANCED SETUP \ n. 10 POLA=1**).

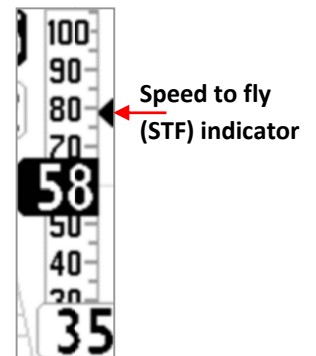

4.6 POLAR (WITH OPTIONAL PITOT TUBE)

- A polar curve (shown in bold on the figure) is the graph of your glider's sink rate over its speed range.

- The glider's stall speed is shown at point **S** on the left and the glider's max speed at point **T** on the right of the graph.
- On the graph, you can also see three pairs of relative speed readings and sink rates. The graph shows, at point **A**, the lowest sink rate achieved at the top of the curve; therefore, **Sink A** is the minimum sink rate and **VA** is the speed at which this is achieved.

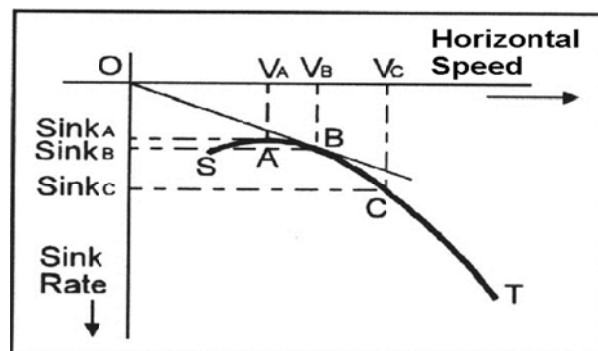

- The glide ratio is the ratio between the glider's horizontal speed and its sink rate. To find the best glide rate on the graph, it is necessary to draw a straight line from the origin of the graph (point **O**) tangent to the curve.
- The intersection of the tangent with the curve (point **B**) shows the speed to fly (**VB**) to achieve the best glide, where you are in **B** sink; so, your best glide ratio is **VB / Sink B**.
- On your Digifly AIR you can insert three different polar curves using the parameters in **ADVANCED SETUP \ n. 11 - 19 PxA / PxB / PxC** where Px is the polar 1, 2 or 3 and A, B and C are the ka-kb-kc are the specific values used by the Digifly AIR to define the polar curve. They must be calculated with a special function within the AirTools program:
 - Open the AirTools program on your computer (PC or Mac), go to the "Configurations" tab, then to "Advanced Setup" and on the P1, P2 or P3 parameters line, next to the factory polar values, you will see a small box with two dots.
 - Click on this box to open the Polar Values Calculator (kz, kb, kc). Using the polar curve of your wing, input the speed and sink values.
 - Click on the "calculate" button to obtain the ka, kb and kc values that you will then manually set in your AIR.
- **Note that** if you want to upload these values to the AIR using the AirTools on your computer, you should first download your parameters, calculate the polar values ka, kb and kc and then upload the entire parameters file. You cannot upload one separate parameter.
- To choose which polar to use, go to (**ADVANCED SETUP \ n. 10 POLA**).
- If this parameter (**ADVANCED SETUP \ n. 10 POLA**) is set to "OFF", all the information relating to **McCready**, **McCready Equivalent**, and **Net Vario** are not displayed on the instrument.
- On the instrument, there are three preloaded polar curves, (2 for hang gliders and 1 for paragliders); using the Digifly AirTools software, you can see the values of the three default polar curves and set your own.
- We suggest that you insert your own polar curve data which best reflects the actual performance of your glider.
- If a polar curve is active, it will be displayed on the top of Standard PAGE 11 (AHRS). Its layout is:
 - ka, kb, kc coefficients (calculated with the AirTools Calculator)
 - Best efficiency value (L/D max eff)
 - Airspeed in km/h at max. efficiency
 - Descending rate at max. efficiency (m/s max eff)
 - Minimum descending rate and corresponding airspeed

905	1599	833	ka	kb	kc
	7.2		L/D max eff		
	34		IAS max eff		
	-1.31		m/s max eff		
	-1.26		m/s min at 31 IAS		

4.7 BAROMETER

- The barometer displays the atmospheric pressure in millibar.
- It is possible to adjust its calibration by changing the **ADVANCED SETUP \ n. 5 KBAR** parameter.
Important: while the recorder is activated is not possible to change this parameter.
Warning: incorrect adjustment of this parameter will make the barometric altimeters less accurate

4.8 TIME

- The current time **RTC (RT)** is constantly updated automatically with GPS data.
- To set the time zone you are in, go to: **MAIN SETUP \ n. 7 UTCO**.



4.9 AUTOMATIC CHRONOGRAPH

- The Chronograph **CHRONO (CH)** shows the duration of your flight.
- It is automatically reset to zero when the instrument is turned ON. It will remain at 00:00 until the flight begins and will stop when you land.
If I take off again, it will reset to zero and start a new time count.

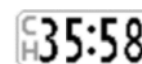

4.10 PILOT'S NAME & GLIDER'S INFO

- To set the pilot name, glider type and glider ID, go to: **MAIN SETUP \ n. 16 PILO**, **MAIN SETUP \ n. 17 GTYP** and **MAIN SETUP \ n. 18 GID**.

5 ADVANCED FUNCTIONS

5.1 MAGNETIC COMPASS (HEADING)

- Magnetic compass (**HEADING**) shows directions related to the magnetic north.
It is made with solid state sensors along the 3 axes, ensuring correct functionality even if not fully leveled.

5.2 G-METER

- The G-meter is made of solid state G-sensors along the 3 axes; its value (**G-METER**) shows the number of “G” at which we are subjected (1G = an acceleration of 9.8m/s² or 32.174ft/s²).

5.3 INERTIAL PLATFORM (AHRS)

- The inertial platform (**AHRS**) produces data regarding space location: pitch, roll and yaw.
Made by a data acquisition system with a complex processing algorithm and 9 solid state sensors: 3 accelerometer sensors, 3 magnetometers and 3 gyroscope sensors.

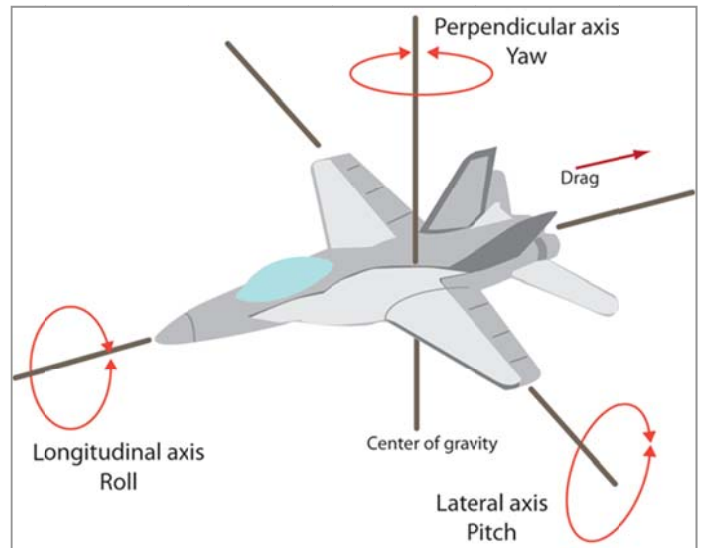

5.3.1 PITCH

- Points out the angle of rotation compared to the lateral axis.

5.3.2 ROLL

- Points out the angle of rotation compared to the longitudinal axis.

5.3.3 YAW

- Points out the angle of rotation compared to the perpendicular axis.

All three values (pitch, roll and yaw) can be found on the "STANDARD" layout of PAGE 11 AHRS.

905	1599	833	ka	kb	kc
	7.2		L/D max eff		
	34		IAS max eff		
	-1.31		m/s max eff		
	-1.26		m/s min at 31 IAS		
140		IAS			
2.2		G METER			
74		PITCH			
-52		ROLL			
-35		YAW			
326		HEAD			
+3.842 v					

6 GPS FUNCTIONS

6.1 INTEGRATED GPS RECEIVER WITH 99 CHANNELS

- Digifly AIR features an extremely sensitive, and state-of-the-art, integrated GPS receiver with 99 channels.

6.2 GPS STATUS INFORMATION

- The GPS status icon has different meanings:
 - 1) Fixed GPS icon = GPS FIX valid (GPS position available) 
 - 2) Blinking GPS icon = insufficient signal (GPS position NOT AVAILABLE)

6.3 GPS SIGNAL QUALITY (HDOP)

- The HDOP value represents the weakening of the GPS signal; lower values mean good precision.

6.4 LATITUDE & LONGITUDE COORDINATES

- The latitude and longitude coordinates are displayed on the upper part of the INFO GPS page and are referred to the WGS84 map datum.

6.5 LATITUDE & LONGITUDE COORDINATES OPTIONS

- Four different coordinate formats are available:
 - DMS = degrees, minutes & seconds (dd° mm' ss.s) (default)
 - DMM = degrees & minutes (dd° mm.mmm')
 - UTM = Universal Transverse Mercator (utm x, y, zone)
 - DDD = decimal degrees (dd.ddddd)To change the coordinate format DMM, DMS, UTM or DDD use the **ADVANCED SETUP \ n. 23 CORD** parameter.
- The latitude and longitude coordinates are referred to the WGS84 map datum.

Lat Lon ddmms.ss		
44 25' 51.3 N		
013 42' 08.4 E		
HDOP 2.4		
ALT GPS	TRK	GS
385	13	35
D56110	CORNIZZOLO	
B49065	SIN	CASCINA STA
B17135	M.TE CORNI D	
B13030	CESANA BRIA	
A01024	SUELLO LAND	
22/11/14		13:42:08
		REC 

6.6 GPS ALTITUDE

- The GPS altitude (“ALT GPS”) is the height above the sea level accordingly to the GPS satellite system.

6.7 GPS GROUND SPEED

- The GPS ground speed is the glider’s speed related to the ground (“Gs”). This value is always displayed - analogically and digitally- on instruments that do not have the Integrated Airspeed Sensor (Pitot Tube).

6.8 GPS DIRECTION (TRK)

- The GPS direction (“TRK”) is the glider’s direction related to the ground.

6.9 GROUND EFFICIENCY (GLIDE RATIO)

- It shows the efficiency (glide ratio) related to the ground.
- To set the time over which the average efficiency (glide ratio) is calculated, go to: **ADVANCED SETUP \ n. 8 EFF**.
- If GPS signal is not available or if the vario value is higher than -0,15m/s (-29.5fpm), the indicator shows: “-.-”.
- To set the time to be used to calculate the **average efficiency** (glide ratio) of the last glide go to: **ADVANCED SETUP \ n. 9 EFFA**. The **average efficiency** value is very important because it is the value used by the glide computer for the glide calculations to the WP (altitude upon arrival, etc.).

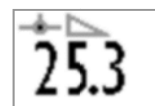

6.10 WIND SPEED AND DIRECTION INDICATION USING GPS

- The wind speed and its direction are automatically calculated using the GPS info Tracking (“TRK”) and the “Ground Speed (“Gs”).
- To determine the wind speed and its direction, you should make a “normal” turn, which has to be neither too tight, nor too wide. It is also important to maintain constant airspeed during the turn.
- For an accurate calculation, at least a 360° turn must be completed.
- This function uses the **ADVANCED SETUP \ n. 22 WSEN** parameter for the wind calculator sensibility (default 5).

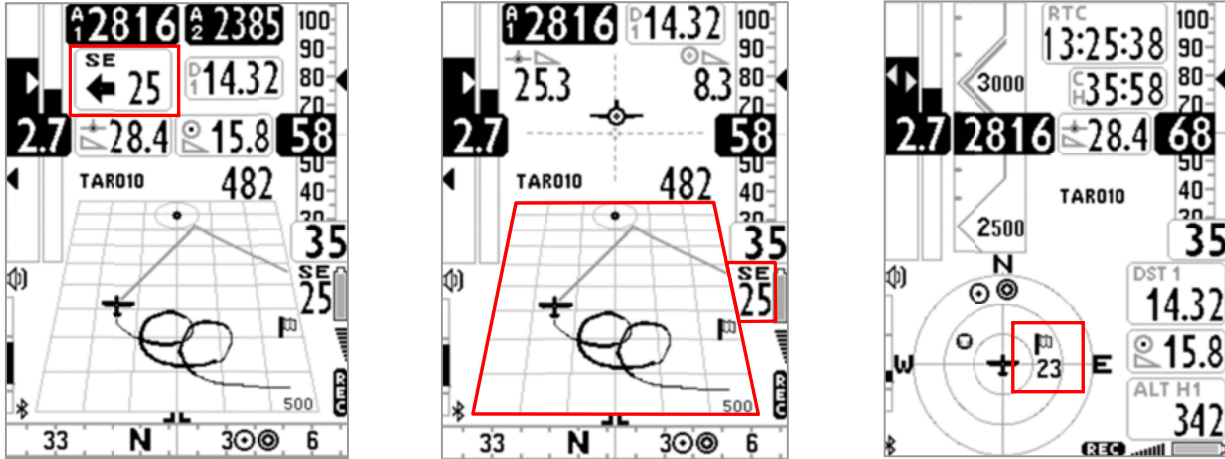

- Wind speed and direction are displayed in different ways on the instrument:
 - On the “Wind Speed” instrument displaying the direction in letters (N, E, SW, etc.); graphically with an arrow and numeric figures (see figure above – left side).
 - On the “Plotter” instrument in two ways: a) Digitally, on the right side of the instrument, showing the direction in letters and the strength in numbers and b) On the grid, it is displayed graphically with a flag showing the direction from where it’s coming from (see figure above – center).
 - On the “Round Compass” instrument it is graphically displayed with a flag showing its direction and its strength in numbers, just below the flag (see figure above – right side).

6.11 LAST THERMAL POSITION, DISTANCE & HEIGHT INFORMATION

- The data: direction “BRG T”, distance “DST T” and altitude gain “A3” are shown on the display when a thermal is detected.
- To recognize a thermal, this function uses the **VARIOMETER SETUP \ n. 17 THET** parameter where the lift’s minimum duration is set (seconds); the AIR is programmed to differentiate a thermal from gliding in a good line.

6.12 THERMAL ASSIST

- It consists of a graphic instrument that uses two concentric circles and a round icon (letter “T” for thermal) to help you to better center the core, taking into account the possible thermal’s wind drift.
- The center of the circles represents our current position and the “T” is the location of the thermal’s core; therefore, we know where to look for it.
- We can also customize the scale of the “Thermal Assist” instrument in order to have a better idea of how far away we are from “T”; when the “T” is in the center of the 2 circles, we are in the core!
- This instrument can be moved on the screen (using AirPages) with a maximum outer diameter of 128 pixels and 40 as a minimum; default 84 pixels.
- This instrument includes the "Thermal Assist Zoom Level" parameter **VARIOMETER SETUP \ n. 19 THEA** from 1 to 20; default is 5 mt/pixel meaning that the first circle has a 100m / 330ft* radius, and the second circle a 200m / 660ft* radius.
- **Keep in mind** that the “Circular Compass” instrument, movable on the screen (using AirPages), includes the “Thermal Assist” instrument as well, which is located on the first two circles.

6.13 THERMAL TUTOR

- The thermal tutor is an innovative function capable of helping you center thermals by displaying their core on the Plotter (a “T”) and draw their trace using lines with variable thickness to provide thermal strength information: the thicker the line, the better the climb. This way, finding the core of the thermal, becomes very intuitive.
- The track on the plotter is redrawn with a new auto-zoom factor each time that you change flight situation, from “thermallng” mode to “gliding” mode and vice versa.
- It switches from “gliding” mode to “thermallng” mode when it feels a new thermal for more than x seconds (**VARIOMETER SETUP \ n. 17 THET**) default 2 seconds and if you make a turn to fly into it.

When this happens, the plotter cleans up and zooms to the maximum level of magnification defined by parameter **VARIOMETER SETUP \ n. 18 THEZ** “Thermal Tutor zoom level”, assigning a scaled value in mt to every pixel on the screen (default 1mt/pixel).

- It switches from “thermallng” mode to “gliding” mode when you fly “straight” for more than x seconds defined in **VARIOMETER SETUP \ n. 16 CRUT**; default =15 seconds. When this happens, the plotter cleans up and the zoom is automatically set on the basis of the calculated distance between the current position and the current waypoint so both can be displayed on the plotter at the same time.

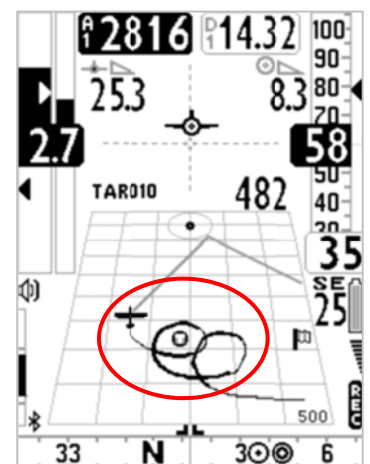
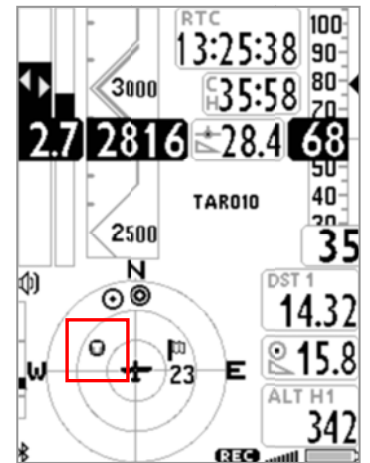
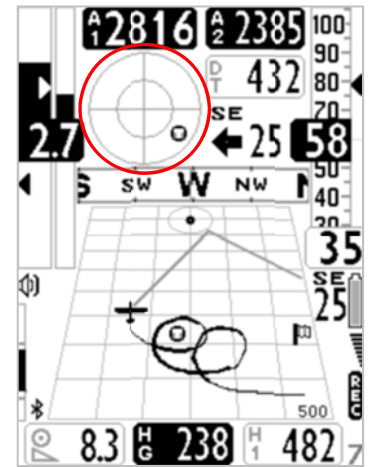

6.14 PLOTTER

- The plotter automatically displays different sets of information depending on the different flight situations.
- **Information that is always displayed during every flight situation:**
 - Aerial position and bearing
 - Wind direction flag
 - Absolute wind direction (ex. SE)
 - Wind strength
 - Track of the last 40sec with variable width depending on the variometer's values (i.e. thicker: better lift)
 - "T" icon (thermal)
 - Scale indicator showing the plotter's width in meters
- **In "thermallng" mode:**
 - The plotter zooms to the maximum level of magnification defined by parameter **VARIOMETER SETUP \ n. 18 THEZ** "Thermal Tutor zoom level", with a range of 1 to 100 m/pixels; default value is 1 m/pixel, corresponding to 25mt per each plotter's square.
- **Information displayed during glide, without any navigation feature active:**
 - The north up symbol "N"
The zoom's value will be fixated at 10 m/pixels, corresponding to 250mt per square.
- **Information displayed in glide when a navigation feature is activated (Route):**
 - Sketch of the current waypoint
 - Dashed line connecting the airplane (you) to the optimized point of the cylinder of the current waypoint
 - Dashed line connecting the optimized point from the current waypoint cylinder to the optimized point of the next waypoint cylinder
The zoom's value is automatically calculated depending on the waypoints' distance
- **Information displayed in glide when the GOTO navigation feature is activated:**
 - Waypoint's sketch
 - Dashed line connecting the airplane (you) to the center of the waypoint
The zoom's value is automatically calculated depending on the waypoint's distance.

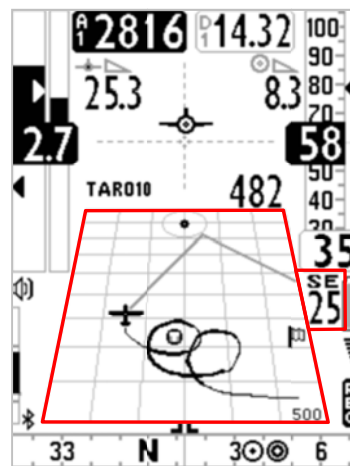

6.15 MAP

- The **Map** instrument enables you to view several graphic information sets (layers) at the same time.
- The Map instrument is to be found on page 12, by default.
- The Map can be placed on any page (using the Digifly **AirPages** software) and it can go from 120x120 to 240x240 pixels and any size in between.
- It is always “North up”
- The zoom is fully automatic depending on the route’s navigation requirements.
- The scale is displayed, on the lower right corner: in meters, up to 1,000 (3,300ft), and in Km over 1,000mt.

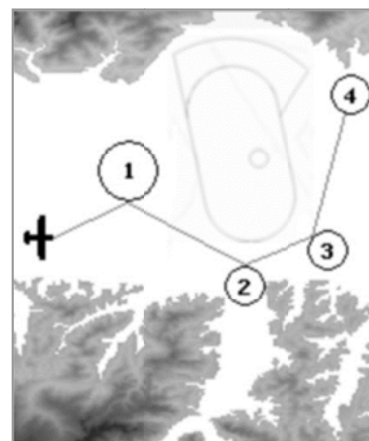

▪ **Map layers:**

- There are three map layers available: Terrain, NAV and CTR

6.15.1 TERRAIN (FIRST LAYER):

- This layer traces the digital elevation terrain map with 10 different shades of grey.
- With your Digifly AIR, you get FREE world wide digital topographic maps! The digital terrain elevation map files are created with the Digifly AirTools free software
- In order to view the Terrain Layer (digital elevation of the terrain) you should have previously:
a) created the digital terrain elevation map files with AirTools, using the “Maps” tab:



- Enter the latitude and longitude (in decimal degrees) of your desired map’s center
- Set the radius in km (e.g. 200km)
- Click on the “Create map” button. The program may prompt you to accept downloading some extra information from the Digifly website. Accept.
- Click on the “Save to file” button to save the new map file in your computer.
N.B. The file name must have the xxxxxxx.dgm format, where “xxxxxxx” can be up to 8 characters.
- Close the AirTools program.
- Insert the microSD card into your computer then copy & paste the map file on the microSD.
- Remove the microSD from the computer and insert it into your Digifly Air with the instrument turned OFF.

Important notes:

- i) Use only microSD cards formatted FAT32, class 10 with at least 8GB and up to 32GB.
- ii) Insert the microSD card with the instrument turned OFF then turn it on, holding down the power key, in order to verify that the SD card is working correctly. The possible messages are: "Micro SD: OK / NONE / ERROR!" In case of error, turn the instrument off, remove the card and try it again.

Digital elevation map selection is automatic: if AGL altimeter or TERRAIN Layer are enabled, as soon as the GPS acquires coverage, the AIR will do an automatic search among the maps available on the microSD card and it will choose the one matching its current position.

b) set the "Elevation Mode" parameter **MAIN SETUP \ n. 19 ELVM = 2** (suggested setting).

ELVM=0: (default) = AGL altimeter disabled and Terrain Map layer disabled

ELVM=1: AGL altimeter enabled and Terrain Map layer disabled

ELVM=2: AGL altimeter enabled and Terrain Map layer enabled showing only elevations above the GPS altitude

ELVM=3: AGL altimeter enabled and Terrain Map layer enabled and it shows ALL elevations

c) set the parameter "Elevation base height" **MAIN SETUP \ n. 20 ELVB :**

It sets the height basis of the Terrain Map's grayscale when ELVM is set to 3 (all elevations displayed).

In this way, you get the most out of the of 10 shades of gray color range the map uses (each shade is called a "step"), corresponding to 10 elevation contour lines.

d) set the parameter "Elevation step" **MAIN SETUP \ n. 21 ELVS:**



It sets the value in meters of each elevation step with a different gray scale of the Terrain Map.

From 10 to 1000m (default value 100m).

▪ Terrain Map setting examples:

When using the Terrain Map, we can define the minimum height at which the TERRAIN elevations are displayed **MAIN SETUP \ n. 20 ELVB** and the height corresponding to each individual step **MAIN SETUP \ n. 21 ELVS**.

For example, in the Fiemme Valley (Italy) with the valley floor at 1,000m (approx. 3,300ft) and maximum peaks at 3,250m (approx. 10,700ft) I can set my ELVB height at min=1,000m and ELVS step at =200m and the map will show the contour lines from 1000m up to 3000m.

- N.B. The Terrain Elevation Map is **not** displayed when the map's side is larger than 100km (62mi), when using a 240x240pixels map, or if larger than 50km (31mi), if using a 120x120 pixel map.
- N.B. It is possible to interrupts the Terrain Elevation Map's drawing by pressing the  or  buttons.
- N.B. The Terrain Elevation Map is **not** displayed when the Navigation layer is set to "NAV photo task" (see 6.15.2 for more details).

6.15.2 NAV (SECOND LAYER)

- The Navigation Layer sketches your active route on the map.
In order to be able to see the Navigation Layer, you need to have an active route or an active “GoTo”.
- The Navigation Layer has 3 different view modes; you can switch among them by **LONG pressing** the  button when you are on a page that has the map instrument on it:

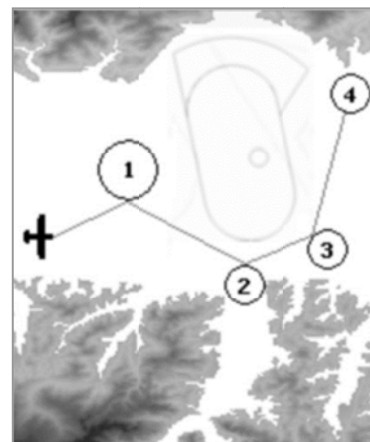

a) Navigation mode in “NAV all remaining waypoints” (default) will display the airplane icon (you) and the waypoints that you still have to fly to. The zoom level is automatically calculated so that the map is “cropped” around these remaining waypoints and the airplane, as shown on the picture.

b) Navigation mode in “NAV only current and next waypoints” will only display the airplane (you), the waypoint that you are currently flying to and the next waypoint after that. The zoom is automatically calculated to “crop” the map around the 2 waypoints and the airplane.

c) Navigation mode in “NAV photo task” will display the whole route without the airplane. The zoom level is automatically calculated to “crop” the map around all the waypoints of your route; the airplane is not displayed.

6.15.3 AIRSPACE CTR (THIRD LAYER)

- This layer displays the airspaces and CTRs on your map. **Important:** this layer is **not** displayed when the Navigation layer is set to “NAV photo task”.
- In order for the Digifly to draw the airspaces and CTRs, you must have previously uploaded the airspace & CTR file to the instrument’s internal memory and have correctly set the following parameters: **MAIN SETUP \ n. 22 CTRM** " enable CTR mode" , **MAIN SETUP \ n. 23 CTRD** "CTR distance warning" and **MAIN SETUP \ n. 24 CTRH** " vertical CTR warning". Detailed instructions for this matter, are found in 6.16.1 below.



6.16 3D AIRSPACE MANAGER

- The “**3D Airspace manager**” function has a very important role in air navigation especially concerning safety since it is constantly verifying -in all 3 dimensions- that our distance from the different airspaces is never closer than the safety threshold we have set, both horizontally and vertically. As soon as you pass these set thresholds, an acoustic alarm will sound and your Digifly AIR will post a warning message on your screen.

6.16.1 UPLOAD AND ENABLE AIRSPACE CTRs TO THE DIGIFLY AIR

- In order to be able to see the airspaces and CTRs, to activate the distance warning messages and alarms, you need to have previously done the following steps:
 - a) Search and download (Internet) the airspace and CTR files from of the flying area in standard OpenAir format.

Websites where you can create and download your own OpenAir airspace files :

<http://airspace.xcontest.org/app/overview>

Websites where you can download ready-made OpenAir airspace files :

<http://www.lk8000.it/download/files/86-waypoints-a-airspaces.html>

<http://soaringweb.org/Airspace/HomePage.html>

<http://www.xcsoar.org/download/data.html>

OpenAir files format documentation :

<http://www.winpilot.com/UsersGuide/UserAirspace.asp>

GpsDump for PC and Android , software to edit and display OpenAir files :

<http://www.gpsdump.no/>

AirTome for PC, software to edit and display OpenAir files:

<https://bitbucket.org/airtome/airtome/downloads>

<https://bitbucket.org/airtome/airtome/wiki/screenshots>

Online converter with the option of selecting the different classes of CTRs: Converter OpenAir -> GoogleMap

<http://cunimb.net/openair2map.php>

b) Using the USB cable supplied, connect your Digifly to the PC/Mac and go to AirTools in the Digifly's Menu.

c) On your computer, open the AirTools program and click on the "AirSpaces" tab

d) Click on "Load from file", set the type of file to "OpenAir (*.txt)" on the pop up browser and select the airspace file you have; for example "ITA_N_ASP2014.txt".

Important : the file may contain up to 500 airspaces and each airspace may contain a maximum of 500 polygon points

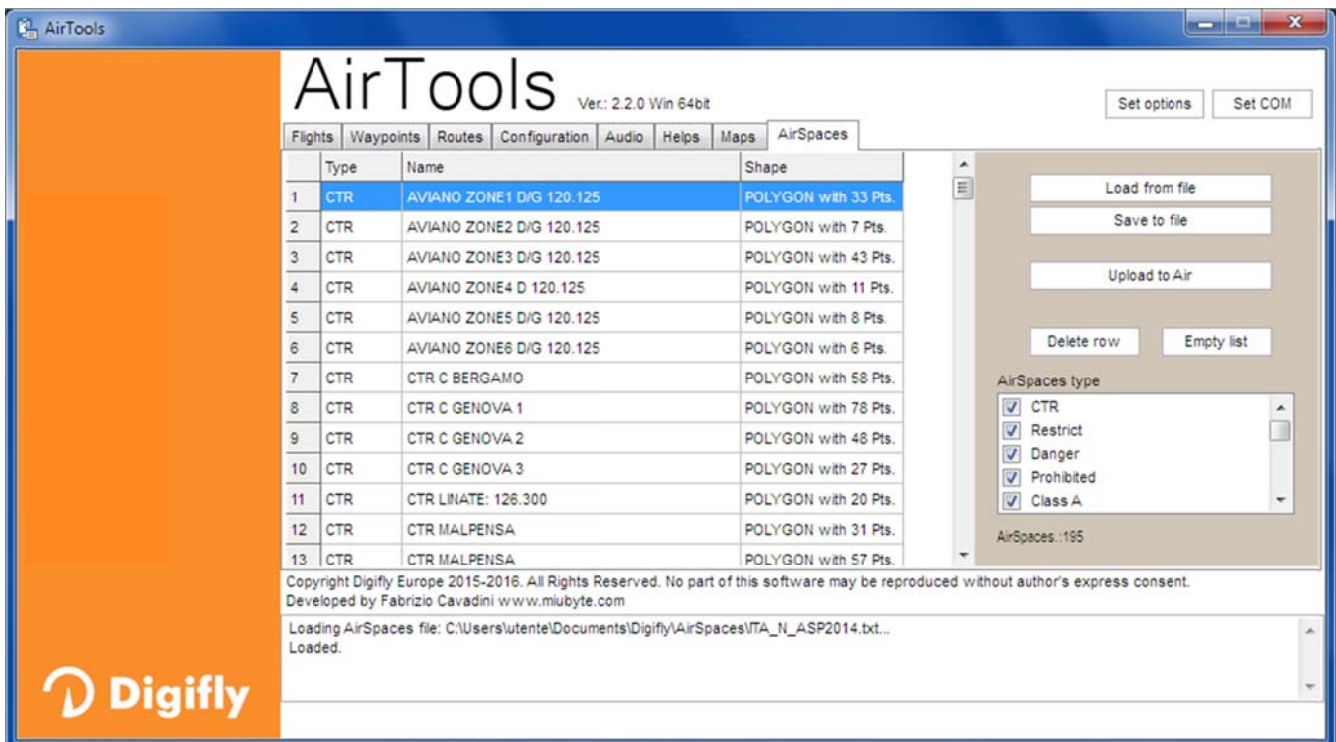

- e) If applicable, deselect the airspaces that you know are not necessary (from the box on the right side)
- f) Click on “Upload to AIR” to upload these files to the Digifly AIR’s internal flash memory
- g) Close the AirTools program
- f) Set the **MAIN SETUP\ n. 22 CTRM parameter (CTR mode) to 1** (enable CTR)
CTRМ: 0=CTR disabled (default), 1=CTR enabled
- h) Set the Distance warning (horizontal) parameter in **MAIN SETUP\ n. 23 CTRD (default is 400mt)**
CTRД : 0=warning disabled, from 1 to 9999= horizontal distance in mt at which the warning message and alarm will go off; this alarm will also go off if you happen to invade the airspace.
- i) Set the Distance warning (vertical) parameter in **MAIN SETUP\ n. 24 CTRH (default is 400 mt)**
CTRН : 0=disabled, from 1 to 999=vertical distance in mt at which the warning message and alarm will go off; this alarm will also go off if you happen to invade the airspace.

6.16.2 VISUAL AND ACOUSTIC DISTANCE WARNING TO THE CTR

- Set the horizontal distance to the airspace, at which your warnings will go off, using the **MAIN SETUP\ n. 23 CTRD** parameter: 0=disabled, from 1 to 9999 mt=enabled (default 400)
- Set the horizontal distance to the airspace, at which your warnings will go off, using the **MAIN SETUP\ n. 24 CTRH** parameter: 0=disabled, from 1 to 999 mt=enabled (default 400)
- When you fly inside the airspace or CTR, no matter what page you may be on, you will hear an alarm and a popup message with warning details will be displayed during 6 seconds.
- To see the last pop-up warning message, **LONG press** the  button while on page 12 (in both STD – standard and USR – user settings); the message will be displayed during 6 seconds.
- The popup warning message and alarm will not be displayed again while you stay inside the airspace. If you fly out and then fly into it again or if you go into the MENU and back out, it will reactivate; in will **not** be reactivated if you simply switch pages.

6.16.3 CTR’s HORIZONTAL DISTANCE INDICATOR

- The horizontal distance to the CTR is displayed as a numeric value, in real time, on the “DST CTR” instrument.



6.16.4 CTR’s VERTICAL DISTANCE INDICATOR

- The vertical distance to the CTR is displayed as a numeric value, in real time, on the “ALT CTR”.

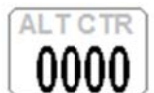

7 WAYPOINT MANAGEMENT

7.1 WAYPOINT DATABASES: COMPETITION & USER

- Two waypoint databases are available: Competition Waypoints (“WPT COMP”) and User Waypoints (“WPT USER”); each one holds 186 waypoints.
- To visualize the Waypoint list, press the  key (“MENU” function) and select the desired WP list.
- The Waypoints can be manually created or can be downloaded from a computer using the AirTools or GpsDump software; for Mac, a GpsDump ‘Mac’ version is available. It is also possible to transfer the Waypoints from Digifly AIR to the other devices via BT using the correct program in each case: AirTools or GPSDump and vice versa.

7.1.1 MANUALLY CREATING A NEW WAYPOINT

- To create a new Waypoint, on the MENU screen select the waypoint database where you’d want to save it.



Highlight the first row (dotted line) then press the  key (“EDIT” function).

The “EDIT” function is described on chapters 2.6.1 and 2.6.2.



- Name:** 6 characters, format aaaNNN (aaa = 3 alphanumeric characters, NNN = waypoint altitude above sea level, in tens of meters). *Note: if the NNN field doesn’t contain three numbers, then the navigation uses the information on the Altitude field.*
- Sym:** numbers from 0 to 9 or the letter A to identify an official landing zone (Airfield).
Note: alphanumerical has 16 characters available.
- Lat / Lon:** Latitude and longitude.
- Altitude:** altitude in meters. *Note: this field is used only if the NNN part of the name field of the waypoint doesn’t contains three numbers.*
- Near:** distance in meters that activates the high frequency flight recorder (one second scan).
- Radius:** radius in meters of the waypoint’s cylinder

Name	Sym
0 4 M 0 1 1	
S T A R T	
Lat Lon ddmms.ss	
44 29' 08. 1N	
011 16' 59. 9E	
Altitude	0110 m
Near	0100
Radius	01400







7.1.2 CREATING A NEW WAYPOINT USING THE CURRENT POSITION (MARK)

- With GPS coverage, you can save the current position in the instrument’s memory using the “MARK” function.
- On the GPS INFO page, LONG PRESS the  key, the " Save Mark?" message is displayed; press the  key to confirm or the  key to cancel. The current position will be saved as a new Waypoint in the USER WAYPOINT list (“WPT USER”) with the nnMaaa (aaa= altitude GPS in tens of meters) format.

7.1.3 EDIT WAYPOINT

- To modify (edit) an existing Waypoint, scroll though the list using the arrow keys  or  until the cursor is on the desired one, then press the  key (“EDIT” function).
- The “EDIT” function is described in chapters 2.6.1 and 2.6.2.

7.1.4 DELETE WAYPOINT

- To delete a Waypoint from the list, enter in the desired Waypoint with the  key, then LONG PRESS the  key and confirm the delete request by pressing the  key, or cancel the procedure using the  key.
- To delete all the Waypoints of a list: while you are inside a WP list LONG PRESS the  key, and confirm the delete request of ALL THE WP with the  key, or cancel the procedure using the  key

8 NAVIGATE TO A SINGLE WAYPOINT (GOTO)



8.1 ACTIVATING NAVIGATION TO A WAYPOINT (GOTO)



8.1.1 NAVIGATION TO WAYPOINT HOME (GOTO HOME)

- Available only when you are on the **GPS INFO** page; it ensures that the instrument guides us back to the point where we activated this function from.

It is particularly useful, for example, when we go flying in a new site where we don't have any waypoints and we want to be guided to the landing zone.







In this case, it is necessary to go to the landing zone and activate this function.

How to activate the "**GOTO HOME**" function: from the **GPS INFO** page, wait until the GPS position is valid, then **LONG PRESS** the  key; the message " Activate Home Wpt ?" is shown, press the  key to confirm or press the  key to cancel.







Note : if a navigation has already been previously activated, first of all it is necessary to deactivate it: from the **GPS INFO** page **LONG PRESS** the  key; the message " Clear Nav ?" is shown, press the  key to confirm or press the  key to cancel.

The "**GOTO HOME**" function creates a landing waypoint in the User Waypoint list ("WPT USER") with the current position data "HOMaaa" (aaa = GPS altitude in tens of meters) and with the icon "A" (airfield) and at the same time activates the navigation (GOTO) to it







8.1.2 NAVIGATION TO THE NEAREST LANDING ZONE (GOTO LANDING)

- To activate this function, wait until the GPS position is valid, go to the menu with the  key, select the sub-menu "Wpt Near Airfield".
- A list of the recorded landing fields (name starts with "A") from both WP databases (USER+COMP) is displayed.
- This list is sorted by "nearest to you" using the distance from the current GPS position.
- The cursor is automatically set on the nearest one. To choose a different one, scroll down the list (use the arrow keys  and ) , select the one you'd like, **LONG PRESS** the  key, then confirm the choice to activate the navigation to this WP by pressing the  key again, or cancel the procedure using the  key.



8.1.3 NAVIGATION TO THE NEAREST WAYPOINT (GOTO NEAREST)

- To activate this function, wait until the GPS position is valid, go to the menu with the  key, select the sub-menu "Wpt Nearest".
- A list of all the nearest waypoints, obtained from both USER & COMP databases, will be displayed.
- The cursor is automatically set on the nearest Waypoint. If you'd like to go to a different one, scroll the list using the arrow keys  and ) , select the new waypoint, **LONG PRESS** the  key then confirm the choice to activate navigation to the WP by pressing the  key again, or cancel the procedure using the  key.

8.1.4 NAVIGATION TO A GENERIC WAYPOINT (GOTO)

- To activate this function, wait until the GPS position is valid, go to the menu with the  key, select a Waypoint database ("Competition" or "User") where the chosen WP is recorded.
- Scroll the list using the arrow keys ,  and set the cursor on the wished Waypoint, select it **LONG PRESSING** the  key then confirm the choice to activate the navigation to the WP by pressing the  key again, or cancel the procedure using the  key.

8.1.5 DEACTIVATING NAVIGATION TO A WAYPOINT (CLEAR NAV)



- To deactivate the current navigation, from the **GPS INFO** page, **LONG PRESS** the  key, the message "Clear Nav ?" is shown, press the  key to confirm or press the  key to cancel.

8.2 NAVIGATION'S FUNCTIONS TO A SINGLE WAYPOINT (GOTO)

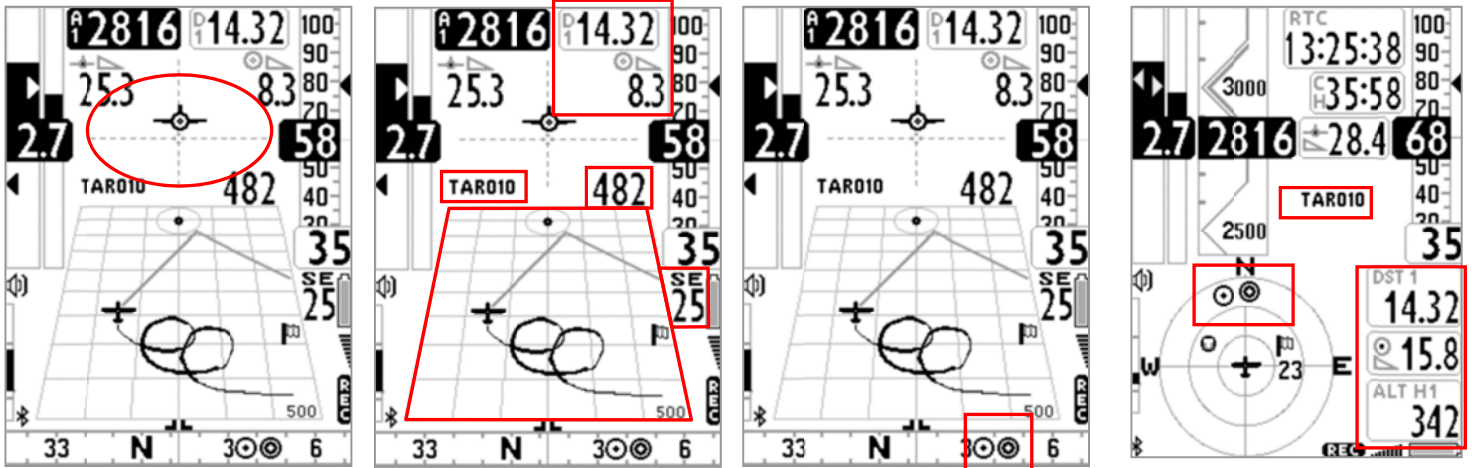
The following navigation's functions are available only if navigation toward a single waypoint (GOTO) is active:



8.2.1 DIRECTION, DISTANCE & HEIGHT TO THE CURRENT WAYPOINT

- **BRG 1 (B1):** is the direction to the current Waypoint; it is shown on the compass with the  icon and the "follow me" symbol 
- **DST 1 (D1):** is the distance to the current Waypoint.
It can be displayed in km or in mi; go to MENU \ MAIN SETUP \ n.15 U-DS.
- **ALT H1 (H1):** is the estimated height of arrival to the current Waypoint.
This height is computed integrating the following information: Altimeter A1, distance to the Waypoint "DST1", Waypoint altitude and average glide ratio.

BRG 1
45

DST 1
14.32

ALT H1
342

The average glide ratio is continuously updated during the glide and stored in the memory during the thermal flight. To change the average time (seconds) use the **ADVANCED SETUP \ n. 9 EFFA** parameter.

The Waypoint's altitude must be included in the Waypoint's name:

- aaaNNN visible on the bottom of the waypoint's page.
- aaa = 3 alphanumeric characters for the Waypoint's name.
- NNN = waypoint altitude above sea level, in tens of meters. **Note:** if the field NNN doesn't contain three numbers, then the navigation uses the information from the Altitude field.

8.2.2 COMPASS TO THE CURRENT WAYPOINT

- There are two types of "Compass" instruments, a circular and a linear one and two models of the linear one. All of them will show you the direction to the current waypoint displayed with the  icon.

8.2.3 REQUIRED GLIDE RATIO TO THE CURRENT WAYPOINT

- It is the estimated required glide ratio to reach the current Waypoint.

 15.8

8.2.4 ARRIVAL HOUR, ARRIVAL TIME TO THE CURRENT WAYPOINT

- It is the expected arrival hour "**TIM1 (T1)**" and the expected arrival time "**ETIM1 (E1)**" to the current Waypoint

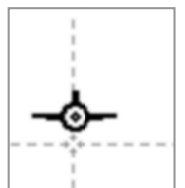

8.2.5 HSI GRAPHIC INDICATION TO THE CURRENT WAYPOINT

- HSI is a graphical navigation tool made by two dashed lines that intersect each other, indicating the current WPT and its real height. Flying towards the center of the WPT cylinder, the airplane icon moves right or left of the dashed vertical line in reference to the route and up or down of the dashed horizontal line telling us whether, with the current glide ratio, we will arrive above or below the waypoint.



9 ROUTE MANAGEMENT





9.1 ROUTES OVERVIEW

- From the main menu, enter in the "ROUTES" sub-menu.
- The first visualized route is the "Rt 01", to select other routes **LONG** PRESS the arrow keys  or .
- It is possible to memorize up to 12 routes from "Rt 01" to "Rt 12" each one containing up to 20 Waypoints
- A route allows to automatically navigate towards the last WP (goal) passing through all the listed WPs.
- For every route, it is possible to insert waypoints from either the Competition or User banks, in any combination.
- The routes can be created manually or can be uploaded from a Computer using the Digifly AirTools software.
- On the "Route" page, the total route distance is also listed in meters "Tot dst m", when the distance units are set to meters; when set to miles, it will be displayed as "Tot dst mil" with the value in MILES x 1,000.





Rt 01		1.04
04M011	S	001400
01M031	A	000400
03M009		000400
01M031	A	000400

OUT	Start	15 : 02
Next Gate		15 min
Tot. Gates		1
Altitude	0110	mt
Tot dst m	035763	





9.2 VISUALIZING WAYPOINT INFO OF A ROUTE

- Using the arrow keys ,  set the cursor on the desired waypoint's line.
- Press the  key to open the drop down menu containing the possible actions, then select "EDIT - VIEW" and confirm with the  key.
- Press the  key to go back the route's page.









9.3 INSERT A WAYPOINT IN A ROUTE

- Using the arrows keys ,  set the cursor on the desired waypoint's line where you want to insert another Waypoint.
- Press the  key to open the drop down menu containing the possible actions, then select "INSERT WPT xxxxx" and confirm with the  key.
- From the Waypoints list select the desired one and confirm with the  key.

9.4 SUBSTITUTING A WAYPOINT IN A ROUTE

- Using the arrows keys ,  set the cursor on the desired waypoint's line where you want to change an existing Waypoint.
- Press the  key to open the drop down menu containing the possible action, then select "CHANGE WPT USER/COMPETITION" and confirm with the  key.
- From the Waypoints list select the desired one and confirm with the  key.

9.5 MODIFY A WAYPOINT IN A ROUTE (PARAMETER CHANGE)

- If you want a waypoint to be your "start pylon/gate" its type must be changed (**Wpt Type = IN/OUT**) and you may even need to adjust the radius of the cylinder (**Radius**) to.
- Press the ,  keys to set the cursor on the desired waypoint's line that you want to modify.
- Press the  key to open the drop down menu containing the possible actions, then select "EDIT - VIEW" and confirm with the  key.
- You'll see a page with all the Waypoint's info, use the arrow keys ,  to navigate to the field you want to modify and confirm with the  key.
- The function "EDIT" is described in chapters 2.6.1 and 2.6.2.
- The waypoint fields that are generally EDITED in a route are:
 - **Sym:** from **0** to **9** or the letter **A** to identify a landing zone (Airfield).
 - **Note:** alphanumeric, 16 characters
 - **Near:** distance (in meters) from the cylinder where the one-second recording interval (oversample) is activated.
 - **Radius:** radius (in meters) of the turn point cylinder
 - **Wpt Type:** "----" = conventional entry by default, "REV" = reverse type (for concentric cylinders with different radii), "IN" = Entry Start Gate, "OUT" = Exit Start Gate
 - **Start Gate Time:** time of the first start (hours:min)
 - **Next Gate:** time interval (in minutes) between start gates
 - **N. Gates:** total number of start gates
 - **Aux:** not used
- Press the  key to go back to the route's page

Name	Sym
0 4 M 0 1 1	
S T A R T	
Lat Lon ddmms.ss	
44 29' 08.1N	
011 16' 59.9E	
Altitude	0110 m
Near	0100
Radius	01400
OUT Start	15 : 02
NextGate	15 min
N.Gates	1
Aux	0



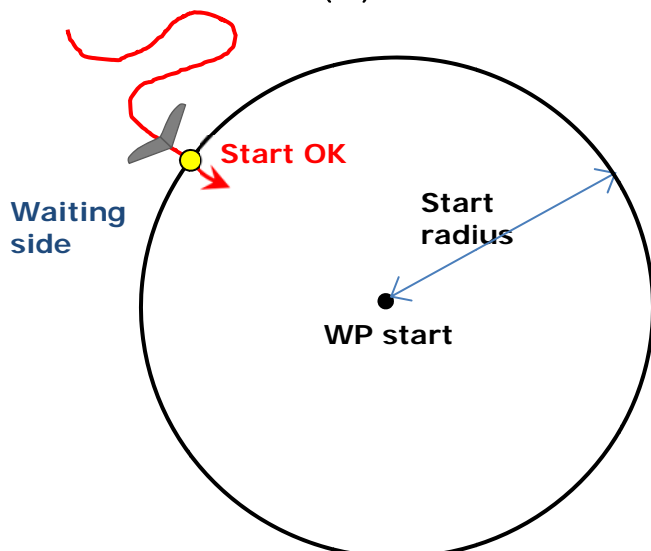

ENTRY START GATE (IN):

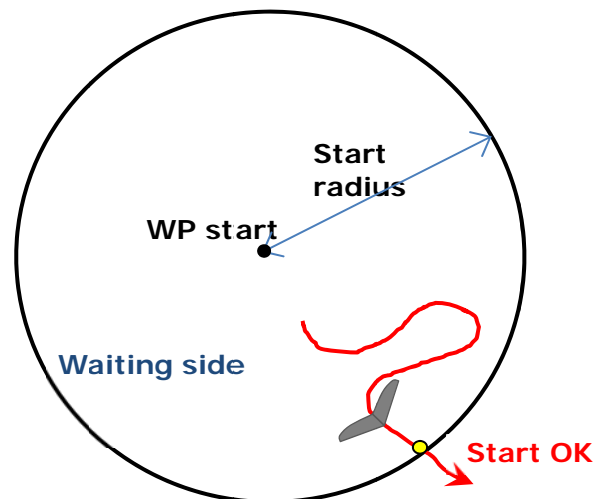



EXIT START GATE (OUT):



9.6 DELETE A WAYPOINT OF A ROUTE

- Using the arrows keys ,  set the cursor on the waypoint to be deleted.
- Press the  key to open the drop down menu containing the possible actions, then select “DELETE”.
- Confirm to accept the cancellation of the WP pressing the  key, or cancel the procedure using the  key.

9.7 DELETING A ROUTE

- To delete a route from the **Routes' Menu**, go into the route to be deleted and **LONG PRESS** the  key; confirm with the  key, or cancel the procedure using the  key.

9.8 NAVIGATION TO CONCENTRIC WAYPOINTS

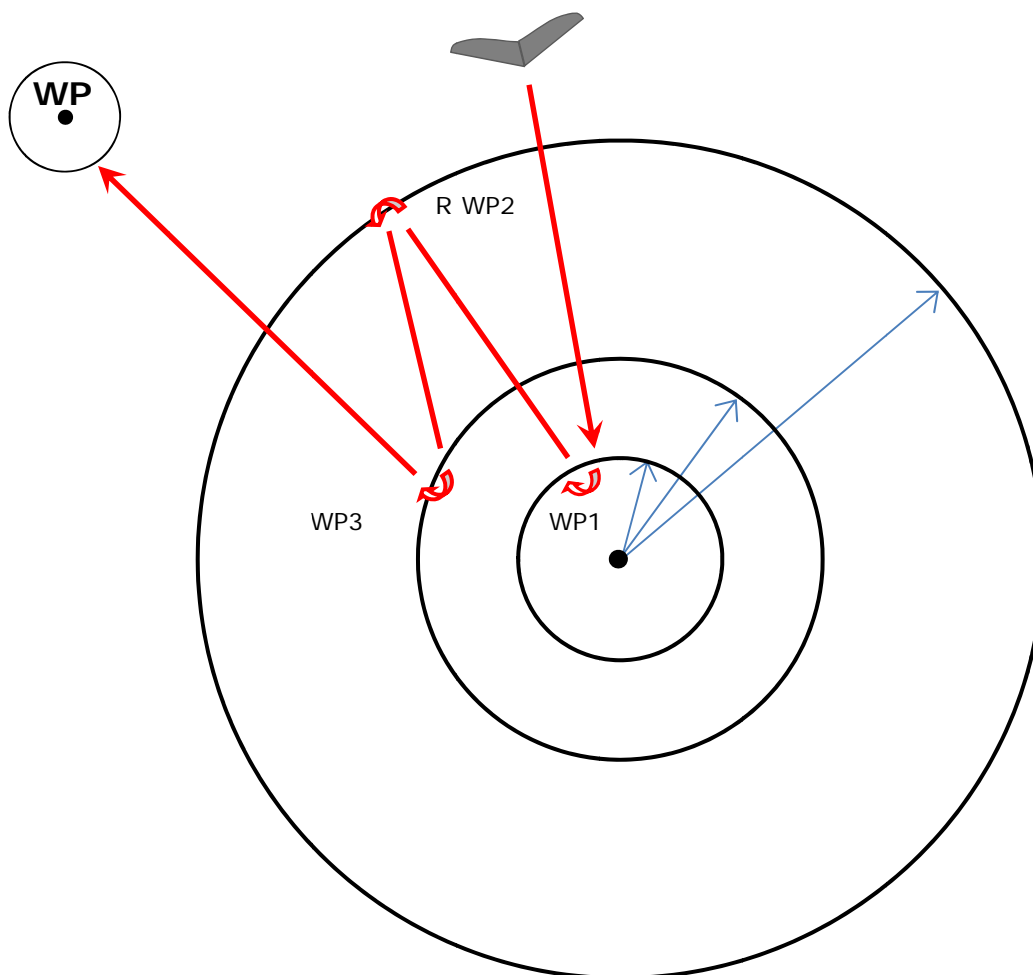

- To properly manage a task's route with concentric waypoints, you need to insert -in your route list- the same waypoint three times, according to the task. Set the different cylinder radii and set the outermost Waypoint's parameter “**Wpt Type**” to "REV" for “reverse type” (WP2 in the example below):





10 ROUTE NAVIGATION

To have this information available a route's navigation has to be activated.

10.1 ACTIVATING A ROUTE

- To activate a route, from the **Menu Routes** enter in the route to be activated and **LONG PRESS** the  key, the message "Activate Route Nav ?" is shown, press the  key to confirm or press the  key to cancel.

10.2 DE-ACTIVATING A ROUTE (CLEAR NAV)

- To deactivate a route, from the **GPS INFO** page, **LONG PRESS** the  key, the message "Clear Nav ?" is shown, press the  key to confirm or press the  key to cancel.

10.3 OPTIMIZED NAVIGATION

- The optimized navigation is always activated and calculated in real time; it shows the pilot the shortest path along the route:

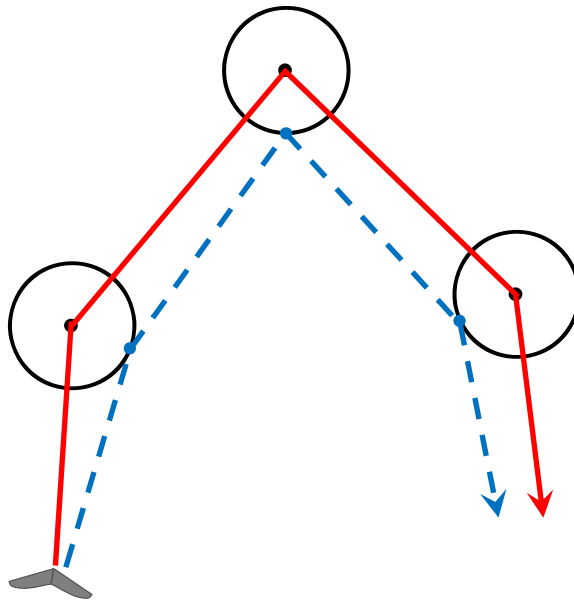

10.4 NAVIGATION TO A STANDARD WAYPOINT

- If the current Waypoint is **not** set as a start pylon, the navigation is managed in standard cylinder mode and the Digifly AIR will guide you providing constant info about your position, distance, direction, required glide ratio and expected arrival height above the current Waypoint cylinder and to the arrival Waypoint cylinder (goal).
- When you get near the Waypoint cylinder, the flight recorder rate is automatically set to one data point per second (oversample); the “NEAR” parameter of any waypoint can be modified in the “Edit” page.
- Cylinder validation: when you enter a cylinder the Digifly AIR will alert you with a sound and you will see a message of “WPOK” (or “TASK FINISHED” if it is the arrival Waypoint), then flight recorder rate returns to the setup value (MAIN SETUP \ n.6 RECR).
- If the navigation is activated the following functions are visible:

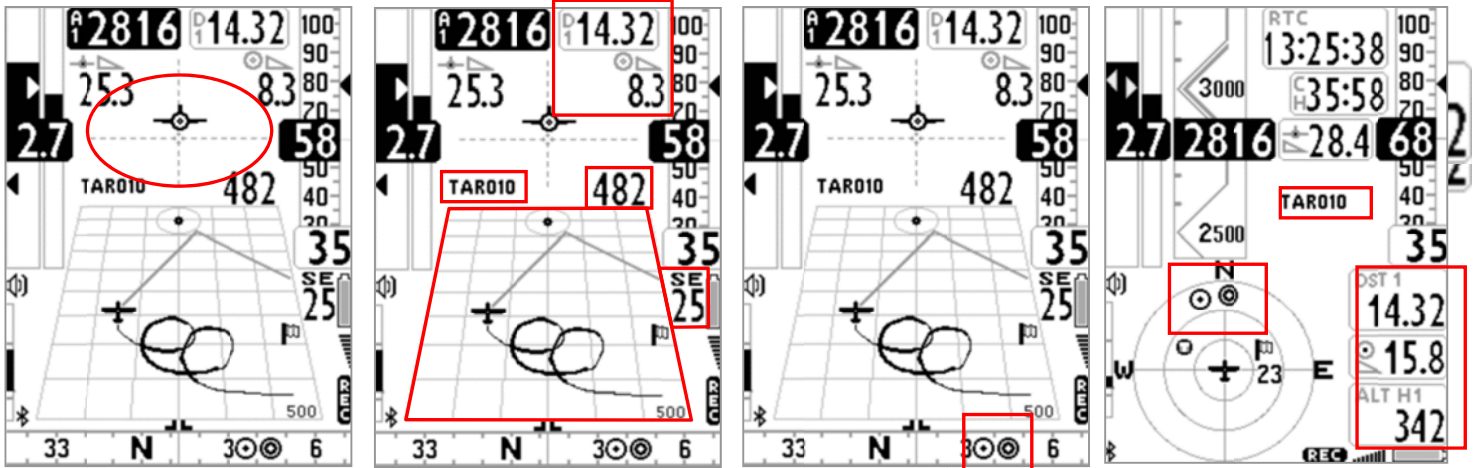
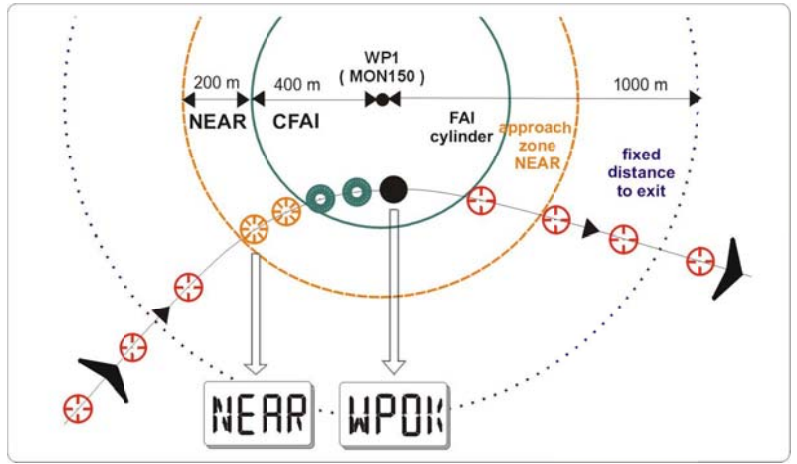

10.4.1 DIRECTION, DISTANCE & HEIGHT OVER THE CURRENT WAYPOINT

- **BRG 1 (B1):** Shows direction to the current waypoint cylinder along the optimized route. It is represented by the icon on the compass and with the "follow me" icon.
- **DST 1 (D1):** Shows the distance to the current cylinder waypoint along the optimized route.
- It can be displayed in km or in mi; go to **MAIN SETUP \ n. 15 U-DS**.
- **ALT H1 (H1):** Shows the estimated arrival height to the current cylinder waypoint along the optimized route.

BRG 1
45

DST 1
14.32

ALT H1
342

This height is computed integrating the following information: Altimeter A1, distance to the Waypoint "DST1", Waypoint altitude and average glide ratio.

The average glide ratio is continuously updated during the glide and stored in the memory during the thermal flight. To change the average time (seconds) use the **ADVANCED SETUP \ n. 9 EFFA** parameter.

The Waypoint's altitude must be included in the Waypoint's name:

- aaaNNN visible on the bottom of the waypoint's page.

- o aaa = 3 alphanumeric characters for the Waypoint's name.
- o NNN = waypoint altitude above sea level, in tens of meters. **Note:** if the field NNN doesn't contain three numbers, then the navigation uses the information from the Altitude field.



- **BRG 0 (BO):** Shows the direction to nearest point of the current waypoint cylinder; also, shown with the  icon on the compass.



- **DST 0 (DO):** Shows the distance to the nearest point of the current waypoint cylinder.



10.4.2 COMPASS TO THE CURRENT WAYPOINT

- There are two types of "Compass" instruments: a circular and a linear compass and two types of linear ones. All of them display the direction to the optimized point of the cylinder (optimized route) using the  icon. It also displays the direction towards the nearest point on the cylinder with the  icon.

10.4.3 REQUIRED GLIDE RATIO TO CURRENT WAYPOINT

- It is the estimated needed glide ratio to reach the current Waypoint's cylinder along the optimized route.



10.4.4 ARRIVAL TIME & TIME TO CURRENT WAYPOINT

- "TIM1 (T1)" shows the estimated arrival time to get to current cylinder waypoint along optimized route and "ETIM1 (E1)" shows how much remains until the estimated arrival time.

10.4.5 HSI GRAPHIC NAVIGATION TO CURRENT WAYPOINT

- HSI is a graphical navigation tool made by two dashed lines that intersect each other indicating the current WPT and its real height. Flying towards the center of the WPT cylinder, the airplane icon moves right or left of the dashed vertical line in reference to the route and up or down the dashed horizontal line telling us, with the current gliding ratio, the arrival height to the waypoint (above or below).

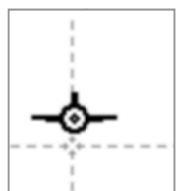

10.4.6 DISTANCE & HEIGHT OVER THE ARRIVAL WAYPOINT (GOAL)

- **DST A (DA):** Shows the distance to the goal cylinder along the optimized route.
- **ALT HA (HA):** Shows the estimated height above the goal cylinder, along the optimized route.



This height is calculated using the following data:

- o Alti A1 (your current height)
- o DST A (distance to the goal cylinder)
- o Average efficiency
- o Altitude of the goal waypoint

10.4.7 REQUIRED GLIDE RATIO TO GOAL

- It is the estimated needed glide ratio to reach the goal 's cylinder, along the optimized route.



10.4.8 ARRIVAL TIME & TIME TO GOAL

- "TIMA (TA)" shows the estimated arrival time to get to the arrival cylinder waypoint along optimized route and "ETIM A (EA)" shows how much remains until the estimated arrival time.

10.4.9 CROSS TRACK ERROR (XT)

- This instrument displays the lateral deviation regarding the NON-optimized route. That is, what is your current distance from the line joining the centers of the two waypoints (past and current) on the current leg. If you are on the right side of the line, the value will be displayed in black over white, but if you are on the left side of it, it will be displayed in reverse (white over black).



Remember to leave the border of this instrument when creating your own pages (with AirPages) otherwise the reverse function will not be enabled and it will always show black over white, as if you were on the right side of the non-optimized route.

10.5 NAVIGATION TO THE START WAYPOINT (GATE)

- The current Waypoint is managed as a Start waypoint only if its parameter "**Wpt Type**" has the value "**IN**" (Entry start Pylon) or the value "**OUT**" (Exit Start Pylon); see 9.5 for more details about the **Wpt Type** setting.
 - When the first start gate time is 10 minutes away, a message appears on the screen: "**10 MIN TO GO !**" followed by a double beep.
 - When the time to the start gate is **00:00**, the "**GATE OPENED**" message appears on the screen, followed by a double beep, telling the pilot that the gate is open and he can now go through the start waypoint (IN or OUT depending on the selected option).
 - When you go through the start waypoint before the gate is opened, the value of the distance to the cylinder line is shown in reverse mode (white on black background) so that you know you're on the wrong side of the circle.
 - The instrument guides us constantly towards the border of the "start waypoint", until it gets crossed correctly when start gate is opened. When this happens the "**WP OK**" message appears, followed by a bitonal sound, then the clock will start showing the time since the gate opened and the navigation instruments will display information regarding the next waypoint.
-
- **IN** = start validation entering the cylinder **OUT** = start validation exiting the cylinder.

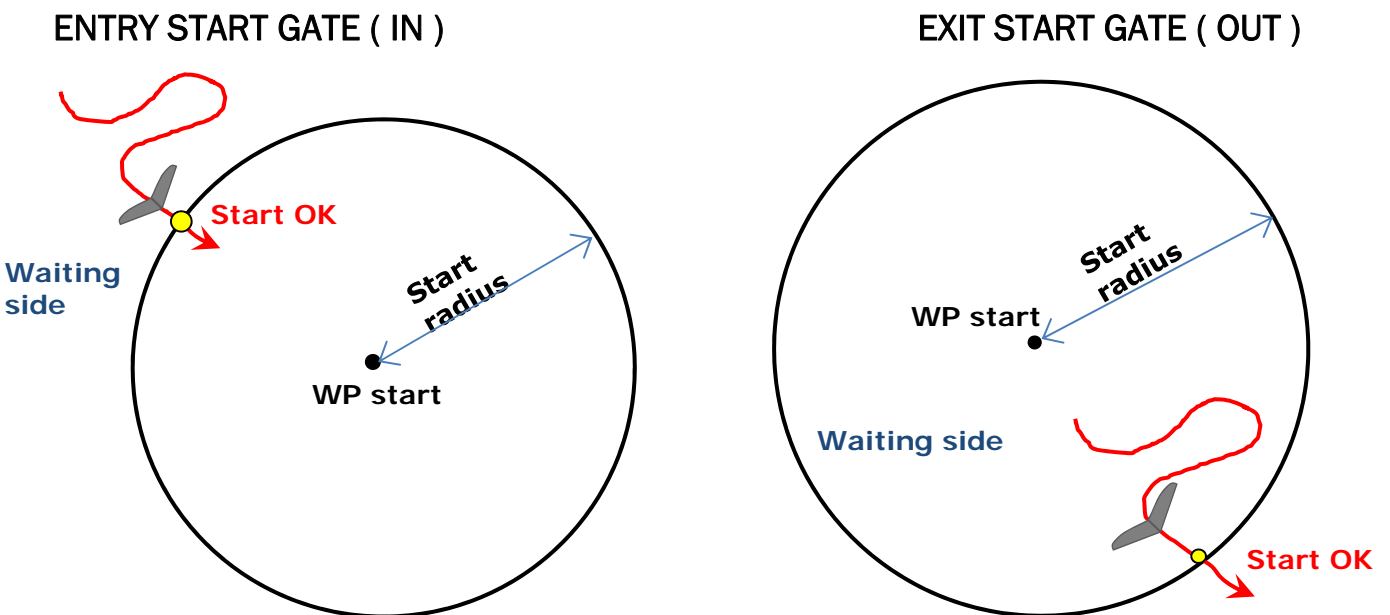

10.5.1 STARTING TIME (TSTART)

- **TSTART:** Shows the start gate time
- When you have an active route, with a start gate waypoint and the track recording is



active, you can forward to the next start gate times by pressing the  button from any page except from the INFO GPS page. Once you get to the last one, it will go back to the first time and start all over again.

10.5.2 REMAINING TIME TO START (CSTART)

- **CSTART (CS):** shows time remaining (countdown) until the start gate opens



10.5.3 EXPECTED ARRIVAL TIME TO START LINE (ESTART)

- **ESTART (ES):** Shows the estimated arrival time to the edge of start cylinder, based on the average speed relative to the countdown. If the instrument indicates "00:10" (black on white), it means the pilot will get to the start line with a delay of 10 seconds; if its written "00:15" in reverse mode (white on black), it means the pilot will get to the start line 15 seconds ahead of time (penalty).



10.5.4 REQUIRED SPEED TO START THE CYLINDER LINE (STS)

- **STS (SS):** shows the required speed to get to the start cylinder line in time for gate opening.



10.6 OPERATION CHECKLIST BEFORE A TASK

- Be sure that batteries are fully charged.
- Download the waypoints from the competition's official web site or get them from the scorekeeper.
- Upload them on the Digifly Air with the AirTools software (PC, Mac) or GpsDump (PC, Mac, Smartphone)
- Edit the route accordingly to the task board's instructions:
 - Insert the turn points cylinders' radii
 - Insert the Start Waypoint type correctly, using the "**Wpt Type**" parameter: set the value "IN" (Entry start) or the value "OUT" (Exit Start); see 9.5 for more details about the **Wpt Type** settings.
 - Insert the start time correctly
 - For multiple start gates (SG), insert the SG interval and Number of SG.
 - In the route page verify that the total distance corresponds ("Tot dst m"), it is calculated from the center of the first waypoint to the center of the last waypoint along the standard route (not optimized).
- Activate the route.
- Set the barometric altimeter A1, this is important as it is also used by the glide computer.
- Before takeoff, turn your instrument on, with enough time to allow a correct GPS position to be acquired.
- After the GPS position, has been acquired, check that the time is correct. If necessary, change the time zone setting, otherwise the start time will be wrong. Parameter: **MAIN SETUP \ n. 7 UTCO**

11 FLIGHT RECORDER

- When the Digifly Air starts the flight recorder, it shows the “REC ON” message and the “rec”  icon, on the bottom of the display, starts blinking. The following parameters are continuously recorded: Date and time, latitude, longitude, number of satellites, tracking GPS, GPS ground speed, altimeter GPS, barometric altimeter A1, variometer and anemometer.
- ***IMPORTANT:*** while in menu no data are recorded.

11.1 ACTIVATING / DE-ACTIVATING THE FLIGHT RECORDER

- The flight recorder can operate in three different ways:
 - “AUT”: Automatic flight recorder.
 - “ALW”: Flight recorder always active
 - “OFF”: Flight recorder deactivated.

11.1.1 RECORDING MODE: AUTOMATIC START “AUT”

- By default setting, the flight recorder starts automatically, **MAIN SETUP \ n. 3 RECM = AUT**
- The flight recorder activates automatically, only if the GPS position is available and it has detected a takeoff with an altitude variation of at least 0,5m (**MAIN SETUP \ n. 4 R.DS = 0,5**) and Ground Speed (GPS) higher than 6km/h (3.7 mph) for 3 consecutive seconds (**MAIN SETUP \ n. 5 R.TI = 3**).
- The flight recorder is automatically deactivated 60 second after landing or if the instrument is turned off.



11.1.2 RECORDING MODE: ALWAYS ACTIVE “ALW”

- To set the "Always Active" record mode, set the **MAIN SETUP \ n. 3 RECM** parameter to “ALW”. The flight recorder is activated once the instrument is turned on and is deactivated when it is turned off.





11.1.3 RECORDING MODE “OFF”

- To deactivate the flight recorder set the **MAIN SETUP \ n. 3 RECM** parameter to “OFF” (no data is recorded).

11.2 RECORDING RATE

- The recorder rate can be adjusted from 1 to 60 seconds, go to: **MAIN SETUP \ n. 6 RECR**).
- Setting 1 data point per second, will record over 30 hours of flight data.
- Setting 1 data point per minute, will record up to 1800 hours of flight data.
- The recorder memory has room for up to 100,000 GPS data points and up to 250 flights.
- When you are **NEAR** a Waypoint, the recorder rate is automatically increased to 1 data point per second.
- When the recorder’s memory is full, the oldest flight is automatically deleted by the newest one.
- The remaining free memory is shown for 2 seconds as the instrument is turned on, or for as long as the power button is pressed when turning the instrument on.
- If a single flight fills the whole memory, it is not possible to use the recorder anymore. The “MEM FULL” message appears every time that you try to use it. To activate the flight recorder again, it is necessary to clear the entire recorder memory. To do this: go to **MENU \ LOGBOOK**, **LONG PRESS** the key  and confirm the cancellation of ALL FLIGHTS by pressing the  key, or cancel the procedure using the key .

11.3 LOG BOOK MANAGEMENT (LOG BOOK)

- To see the recorded flights, select the menu “LOGBOOK”. The list of all the recorded flights will be displayed with their date and take off time.
- To see details of each recorded flight, select a flight the press the  key.
 - For every flight the following information is displayed:
 - Take off date and time, flight duration, and total altitude gain.
 - Max. and min. values for Altimeter A1 and Variometer
 - Max values for Ground speed GPS and Indicated Airspeed (IAS)
- To delete all the flights of a list: from the menu “LOGBOOK LONG PRESS the  key and confirm the cancellation of ALL THE FLIGHTS by pressing the  key, or cancel the procedure using the  key.
- It is not possible to delete a single flight.

Suggestion: *It is a good practice to clear up your flight memory before the start of a competition. You can save your flight on your computer before doing this.*

12 ADDITIONAL MEMORY CARD

- On the Digifly AIR's housing, besides the miniUSB connector, you will find the **microSD HC Class 10** memory card reader slot, with a capacity ranging from 8GB to 32GB, formatted FAT32.
- To insert a memory card, your instrument should be OFF. Place the card with the label facing the instrument's keyboard side and insert the card's connector side in the instrument; to lock the memory card it is necessary to gently press it with your fingernails (or another microSD) until it you hear the typical “locked” click.
- To extract the memory card, turn your instrument OFF, press the SD card and let it go, to release it.
- **Warning:** *The instrument **should be turned off** to insert or extract the card. Beware that if the card is inserted incorrectly, it could damage the instrument void its warranty.*



13 CONNECTIONS & INTERFACES

- It is possible to connect your Digifly AIR-SE and AIR-BT to a PC, Mac, Smartphone, Tablet, PDA, etc. using the provided USB cable. The Digifly AIR-BT allows also the connection via Bluetooth.

13.1 USB CABLE CONNECTION

- To connect your AIR via USB cable, you need to install the FTDI USB Cable Driver on your PC or Mac.
- USB cable driver automatic installation**
Connect the USB cable to the PC/Mac and to the instrument, while connected to the Internet and the operative system will usually download and install the FTDI driver automatically.

- USB cable driver manual installation**

If the automatic installation is not successful, you need to manually install the FTDI driver:

- Disconnect the USB cable from the PC/Mac and from the instrument
- Download the proper driver installation program accordingly to the PC/Mac in use from www.digifly.com
-> download -> FTDI USB Cable Driver.
- Unzip the downloaded files and run the driver installation program.
- Restart your computer.
- Reconnect the USB cable to the computer and to the instrument.

- Verify proper installation of the USB driver:**

- Connect the USB cable to the PC/Mac
- For example, from Windows7, go to Start -> Control Panel -> System and Security -> System -> Device Management.
- Click on the "+" sign next to "Ports (COM e LPT)".
- If the driver is correctly installed, you will see the "USB Serial Port (COM X)" without any yellow indication of error. **Note:** The 'X' is the number of the COM port assigned to the computer's USB.
- The driver type is visible with a right click on your mouse over "USB Serial Port" then click on "Properties"; if the driver is installed it will show "FTDI".

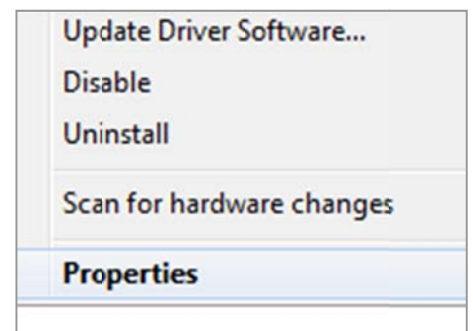
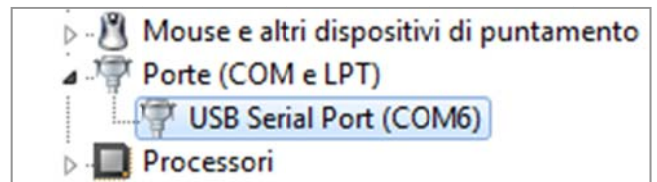

- How to manually reassign the COM port number:**

- All Digifly software performs the automatic search of the COM port in the range of 1 to 20; a third-party software in most cases requires that the COM port is in the range from 1 to 9.
If the COM port assigned by the computer has a higher number it is necessary to manually reassign it:
- Connect the USB cable to the PC/Mac
- Right click on "USB Serial Port" then click on "Properties"
- Click on "Port settings" then click on "Advanced"



- In the "Advanced Settings" window, set the "COM Port Number" with the lowest number (from 1 to 9) among the ports that aren't already in use, then click "OK"

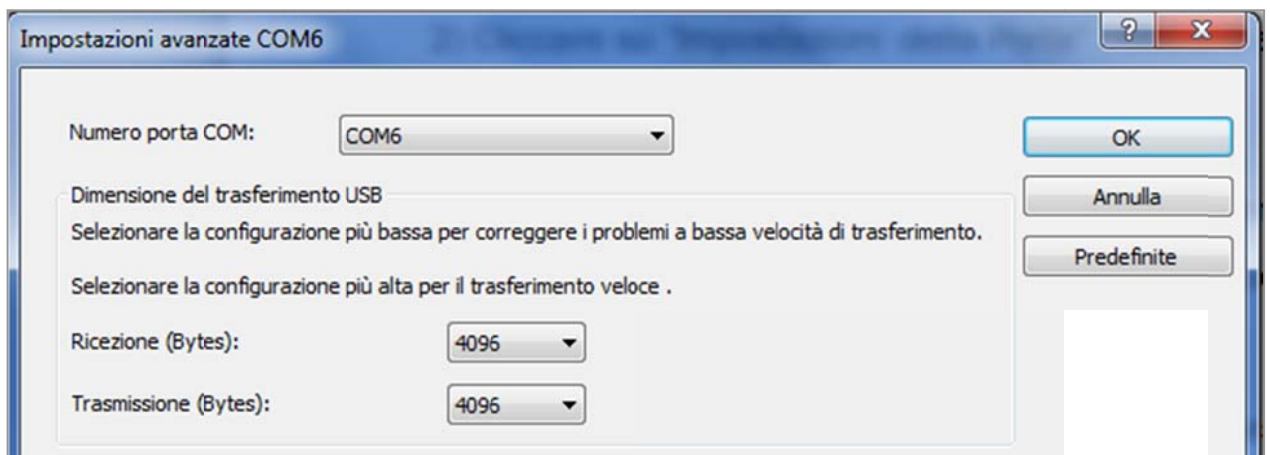

Note: If the value displayed on the "Device Manager" window is still the old one, refresh the display value by closing and reopening this window.



- Take note of the COM port number, to be used later on to manually set the correct port number of third-party software (e.g. GPSDump).

Please note that all Digify software has automatic COM port number detection (Auto search) and therefore it does not need this setting.

13.2 BLUETOOTH CONNECTION (AIR-BT ONLY)

- The communication possibilities offered by the fully functional Bluetooth system on the Digifly AIR BT instrument are extraordinary and practical! There are two major lines when using your Bluetooth:
 - 1) Upload and download of different types of data (waypoints, flights, tracklogs, routes, airspace files, settings, etc.) between your instrument and a wide array of devices, also operating with the Bluetooth system, using either the Digifly AirTools program and/or GPSDump, depending on the type of device (PC, Mac, Android or Apple devices).
 - 2) Telemetry Function, which really marks a difference and shows the quality of this instrument. This function allows your Digifly AIR BT to send its telemetry (data from its sensors: barometric altitude, GPS altitude, ground speed, IAS speed -with Pitot Tube system-, vertical velocity, GPS position, etc.), in the international NMEA format, via Bluetooth to another device it has previously paired, so that this data can be used directly by specialized programs such as XCSoar, XCTrack and LK8000. This information (telemetry) can also be used to live track to any server using, for example, GPSDump on an Android phone; this means, the Digifly AIR-BT also serves as a "info box = sensor box = a data source"

13.2.1 BLUETOOTH "PAIRING"

- The communication via Bluetooth between Digifly AIR-BT and an external device (PC, Mac, Smartphone, Tablet or PDA) is possible only after pairing the two devices, here is how to proceed:
 - 1) On the **AIR-BT**, set the **ADVANCED SETUP \ n. 26 BLUT** parameter to "ON".
 - 2) Enter the MENU page and go to "**AirTools**"
 - 3) You will be prompted to choose whether to communicate via USB cable or via Bluetooth with the message "Press OK to link USB, Press DOWN to link BT or Menu to exit", press the  key.
 - 4) **AIR-BT** looks forward to the pairing request from the external device.
 - 5) From the Bluetooth's control panel of the external device, press the option "Search".
 - 6) A list of available devices is created, select "Digifly Air nnn" (where "nnn" are the last three digits of your instrument's serial number).
 - 7) When prompted, enter the pairing code of the AIR-BT which is "0000" and then confirm; if the procedure is successful, the external device displays a message confirming that the Digifly AIR BT is paired.
- Once the AIR-BT has paired with a device, it is no longer necessary to repeat the pairing process.
- In case of problems, press the  key on the **AIR-BT** to exit and try it again.

13.2.2 BLUETOOTH COMMUNICATION WITH MANAGEMENT SOFTWARE OF THE INSTRUMENT

- The GPSDump app installed on an Android smartphone, allows to manage your Digifly AIR-BT instrument via Bluetooth to upload and download waypoints, flights and tracklogs.

In order to use this software, you must have already previously paired the devices (see 13.2.1). It also requires that the parameter (**ADVANCED SETUP \ n.26 BLUT**) is set to "ON" (Bluetooth enabled).

The sequence of operations to use the software via Bluetooth is the following:

- 1) In the **AIR-BT**, go to the MENU page, then to "AirTools" and press the "OK" button.
- 2) You will be prompted to choose whether to communicate via USB cable or via Bluetooth with the message "Press OK to link USB, Press ARROW DOWN to link BT or MENU to exit"; press the  key.

3) Run the software on the external device (e.g. GPSDump for Android Smartphone)

4) As the **AIR-BT** starts to communicate with the external device, it displays a "Link BT" blinking message.

- In case of problems, exit by pressing the  key on the **AIR-BT** and try again.

13.2.3 BLUETOOTH COMMUNICATION WITH SOFTWARE DECODING THE DIGIFLY TELEMETRY

- Software that can receive, decode and display the **Digifly Telemetry Data** sent in real time at high speed from the AIR-BT via Bluetooth are XCSoar, LK8000, XCTrack and GpsDump.

In order to use this software, you must have already paired the devices (see 13.2.1). It also requires that the **ADVANCED SETUP \ n. 26 BLUT** parameter is set to "ON" (Bluetooth enabled) and that the (**ADVANCED SETUP \ n. 25 TELE** parameter is set to "FL2" for XCSoar or "FL3" for XCTrack depending on which of the programs you are looking to sending the telemetry to (sending Digifly telemetry data enabled).

The sequence of operations to use this software via Bluetooth is the following:

1) On the **AIR-BT**, go to MENU \ "**Telemetry BT**".

2) Run the software on the external device (e.g. XCSoar on Android Smartphone).

3) When the AIR-BT gets confirmation that it is connected to the external device, it automatically exits from the "Telemetry BT" menu, returns on the current page, turns the Bluetooth icon "ON" and activates the continuous transmission of real-time Digifly telemetry data at high speed.

- In case of problems, press the  key on the **AIR-BT** to exit and try again.



14 SOFTWARE

14.1 AIR MANAGEMENT SOFTWARE

- Your Digifly Air uses the Digifly protocol, which enables high speed communication with the applications having it embedded in their interface (e.g. AirTools, AirPages and GpsDump); thanks to this protocol it is possible to remotely access & configure your vario. **Important:** *always run only one program at a time!*

14.1.1 DIGIFLY AIRTOOLS (PC / Mac) SOFTWARE

- The Digifly “AirTools” software is available for both Windows and Mac, to download for free at www.digifly.com.
- Digifly “AirTools” allows the full management of: flights, routes, waypoint, settings, the help language of the “SETUP PARAMETERS”, the complete personalization of the vario’s acoustic profile, airspaces and creating worldwide digital topographic maps.
- Connect the PC/Mac to the Digifly AIR and turn them both on.
- On the AIR, go to MENU \ "AirTools" where the blinking “LINK” message is displayed.

Note: if the Bluetooth is enabled (only AIR-BT), you are prompted to press  or  to choose whether to communicate via USB or Bluetooth; press then  (USB).

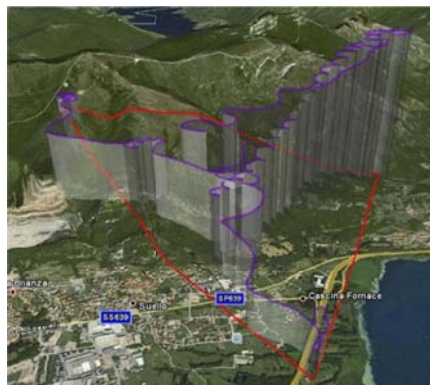
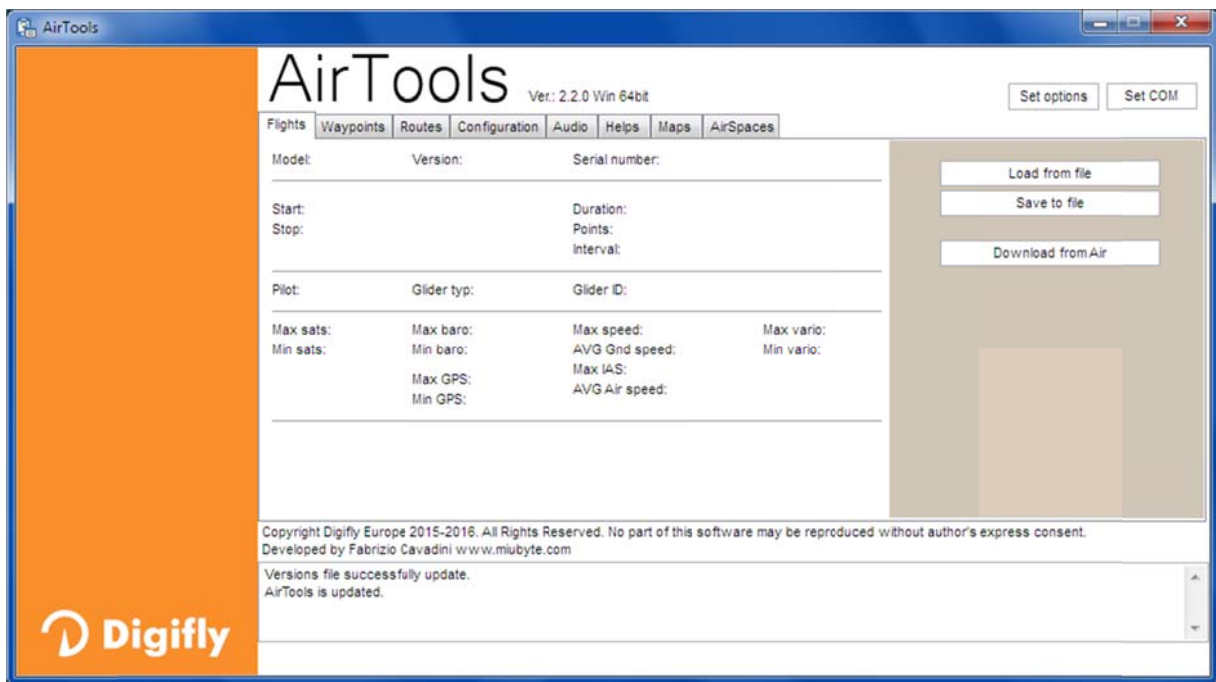

- On your PC/Mac run the Digifly AirTools program.

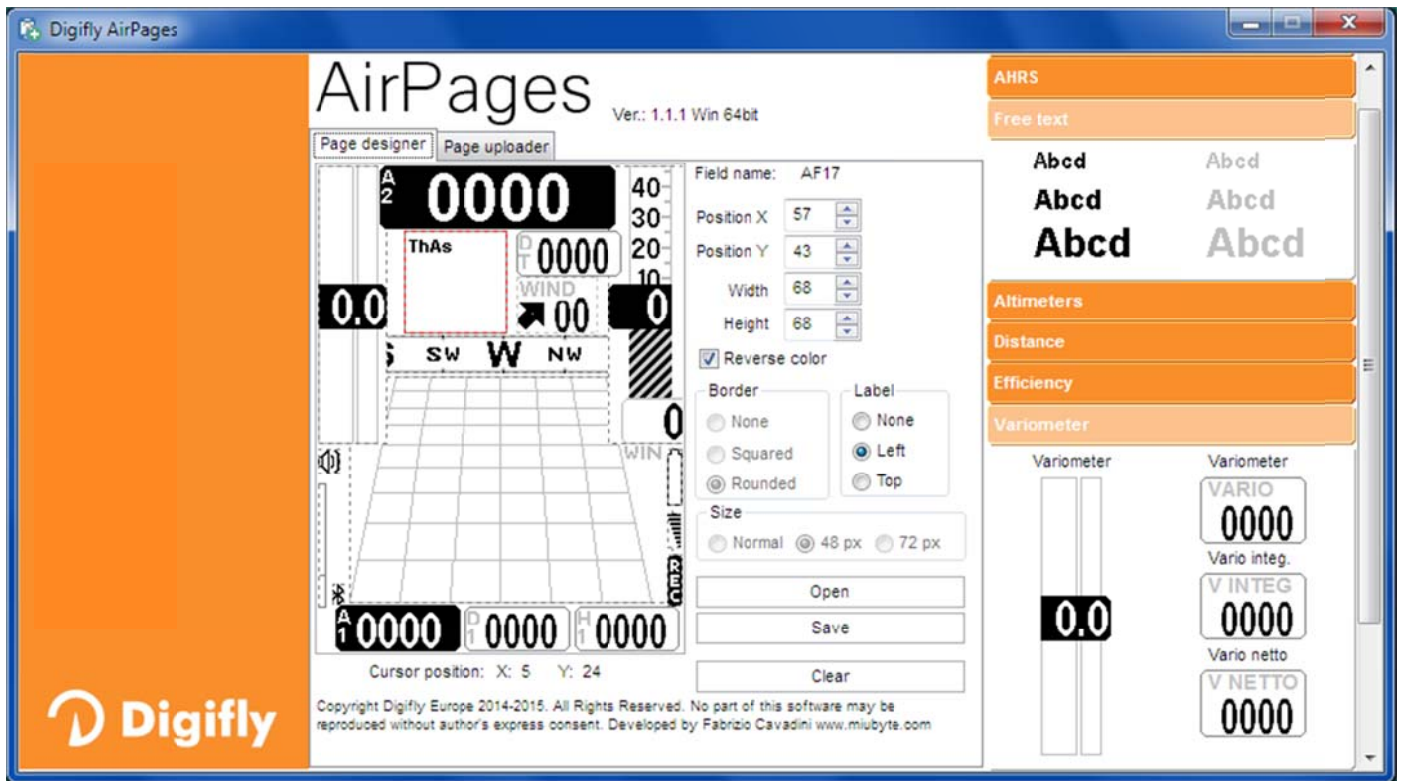

14.1.2 DIGIFLY AIRPAGES SOFTWARE FOR PC OR MAC)

- The Digifly “AirPages” software is available for both Windows and Mac, to download for free at www.digifly.com. It gives you the possibility to create and graphically configure the “User Pages”, so that you can then upload them to the 12 configurable pages of the AIR instrument (GPS Info page is not configurable).



- Connect PC/Mac to Digifly and then power them both up.
- On the AIR, go to MENU \ "AirTools" where the blinking “LINK” message is displayed.
- Note:** if the Bluetooth is enabled (only AIR-BT), you are prompted to press  or  to choose whether to communicate via USB or Bluetooth; press then  (USB).
- On your PC/Mac run Digifly AirPages.
- It is possible to start creating your own User pages from a blank page or using one of the *.dat files available on the installation set up (click "Open" and choose a *.dat file; for example, Claudio3.dat).
- Drag and release the desired instruments on workspace.
- To cancel an element from workspace, right click on it and select “delete”.
- To upload your page to the instrument, click on "Page uploader" click on "Set page", select the configurable page of your instrument to which you want to upload your User page (i.e. "Pag 1"), click "Start" and wait until the upload is complete; **remember** to select “AUTOSEARCH” under “SET COM” in case you are not sure which port your Digifly AIR is using.
- On the AIR instrument, set the “USR” value for the corresponding page that has been uploaded (in our example, Page 1, so the parameter is MAIN SETUP \ n. 26 PG1).

Claudio.dat

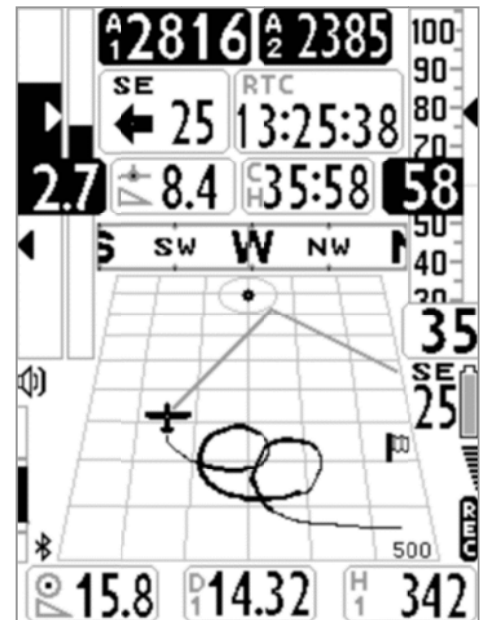

- Your Digifly AIR comes with twelve (12) customizable pages; **each** one of them is linked to one of the twelve (12) configurable parameters (**MAIN SETUP\ n. 26 to 37 - PG1 to 12**) and for **each** page it is possible to configure a different layout:

OFF = the layout view of the page is disabled (the page will be skipped)

STD = it will show the corresponding layout of the preset page by Digifly (pgs. 1 - 12) that come with your AIR.

USR = it will show the corresponding layout of the page "USER PAGE 1 to 12" created and uploaded by the User with the FREE Digifly **AirPages** program.

▪ **REFERENCE TO NAME AND CONTENT OF CUSTOMIZABLE PAGES**

- PG01 page_1_IntelliComp_flight_thermal **OFF/STD/USR**
- PG02 page_2_IntelliComp_flight_glide **OFF/STD/USR**
- PG03 page_3_IntelliComp_start_thermal **OFF/STD/USR**
- PG04 page_4_IntelliComp_start_glide **OFF/STD/USR**
- PG05 page_5_IntelliComp_goal_thermal **OFF/STD/USR**
- PG06 page_6_IntelliComp_goal_glide **OFF/STD/USR**
- PG07 page_7_IntelliXc_cross_thermal **OFF/STD/USR**
- PG08 page_8_IntelliXc_cross_glide **OFF/STD/USR**
- PG09 page_9_compass **OFF/STD/USR**
- PG10 page_10_relax **OFF/STD/USR**
- PG11 page_11_ahrs **OFF/STD/USR**
- PG12 page_12_map **OFF/STD/USR**

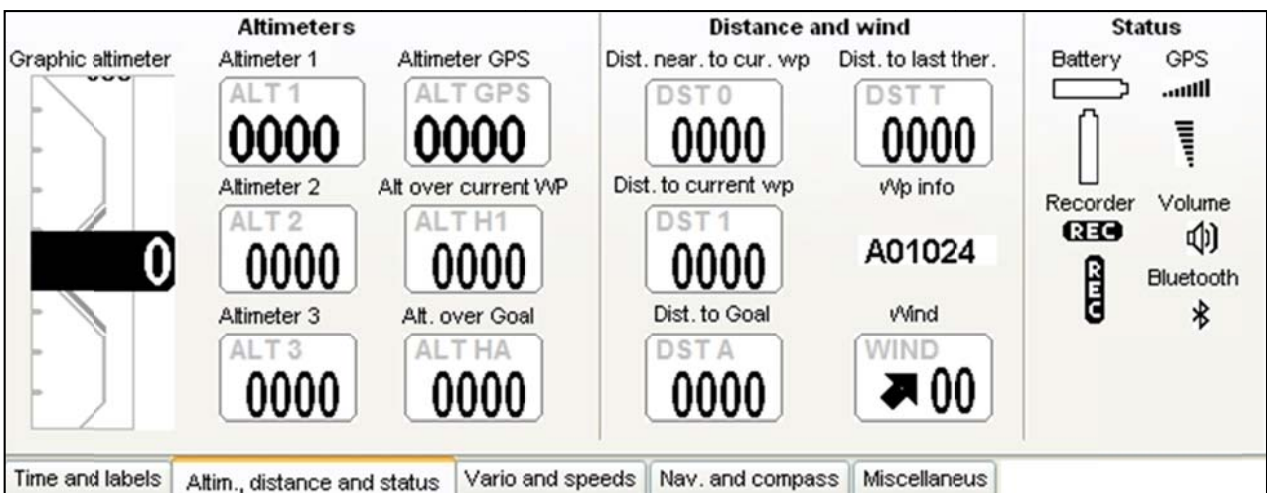
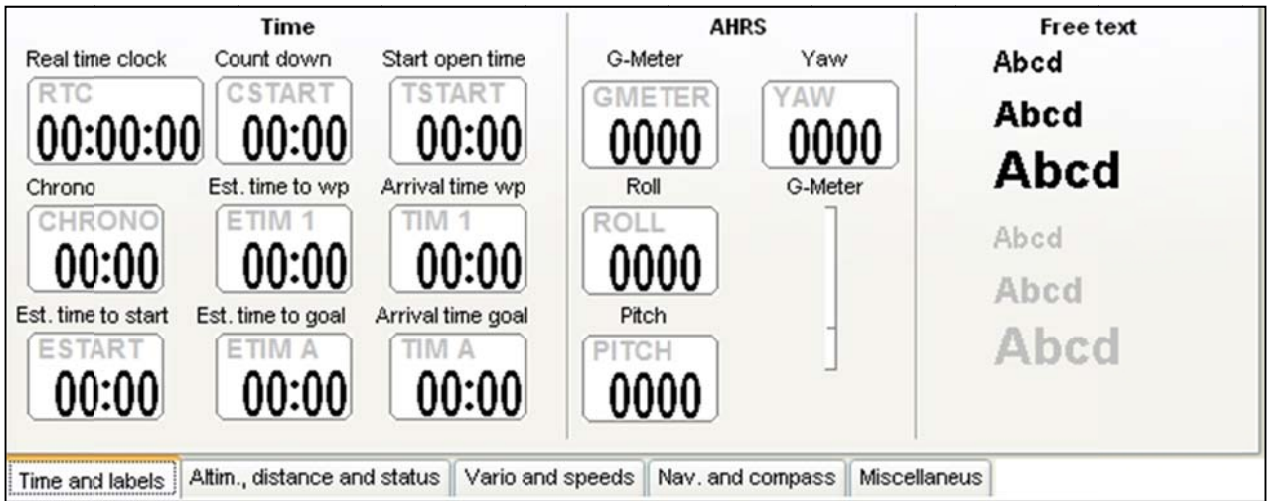



Variometer	Speed	Efficiency
Variometer VARIO 0000 Vario integ. V INTEG 0000 Vario netto V NETTO 0000	Air speed IAS 0000 Ground speed GS 0000 Speed to start STS 0000	Instant efficiency 000 Req. Eff. to WP 000 Req. Eff. to Goal 000
Time and labels Altim., distance and status Vario and speeds Nav. and compass Miscellaneous		

Navigation	Graphic navigation
GPS Tracking TRK 0000 Bear. wp cent. BRG 0 0000 Bear. wp opt. BRG 1 0000	Bear. last ther. BRG T 0000 Mag. heading HEADING 0000 Follow Me
Time and labels Altim., distance and status Vario and speeds Nav. and compass Miscellaneous	

Barometer
Pressure in MB MB 0000
Time and labels Altim., distance and status Vario and speeds Nav. and compass Miscellaneous

14.1.3 GpsDUMP SOFTWARE (PC, MAC, ANDROID)

- GpsDump is the most commonly used free software among the free flight organizers to manage competitions; it integrates the Digifly protocol. It allows full management of flights, routes and waypoints; operations also possible via **Bluetooth** with a Smartphone (AIR BT models only).
- Through GpsDump on your smartphone, the “Live Track” feature is also available (AIR BT only), in this case you need to set parameter **ADVANCED SETUP \ n. 25 TELE=CAR**.
- On the **AIR**, go to MENU \ "AirTools", the blinking “LINK” message is displayed.
Note: if the Bluetooth is enabled (only AIR-BT), you are prompted to choose whether to communicate via USB or Bluetooth; press  for PC/MAC or press  for Bluetooth Smartphone.
- Run the GpsDump program, select “GPS type”: if you are connected via USB, scroll down the menu until you find “Digifly AIR” or if you are connected to a Bluetooth Smartphone, scroll even further until you find the section “Bluetooth devices”; click on it then scroll down to “Digifly Air nnn” (where “nnn” are the last 3 digits of you AIR’s serial number).
- The following images, sample some of the program’s features:

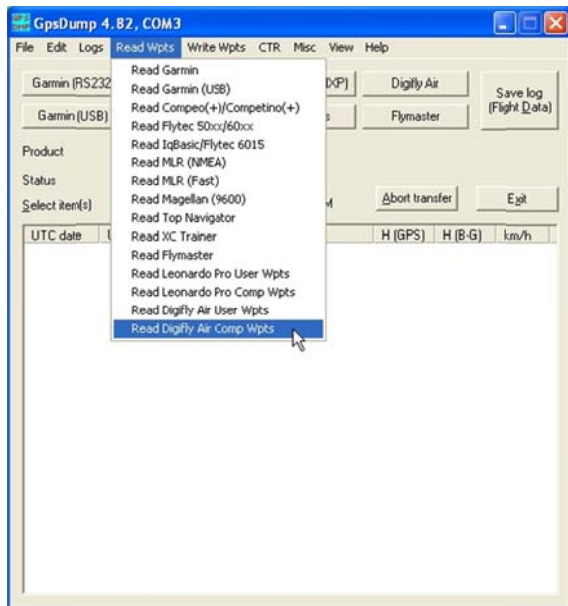
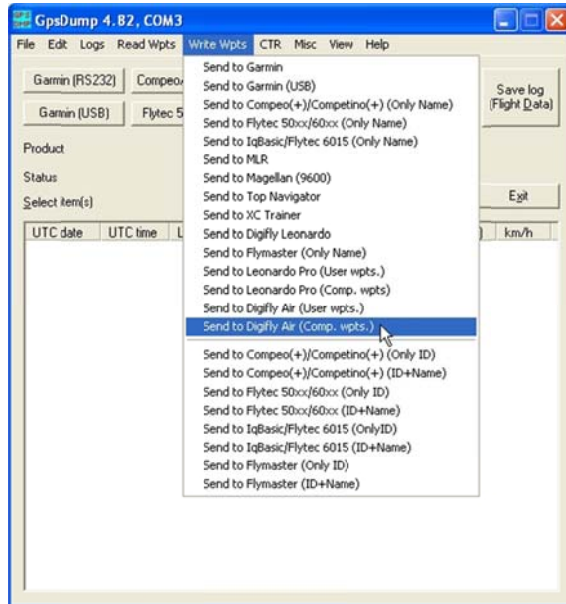
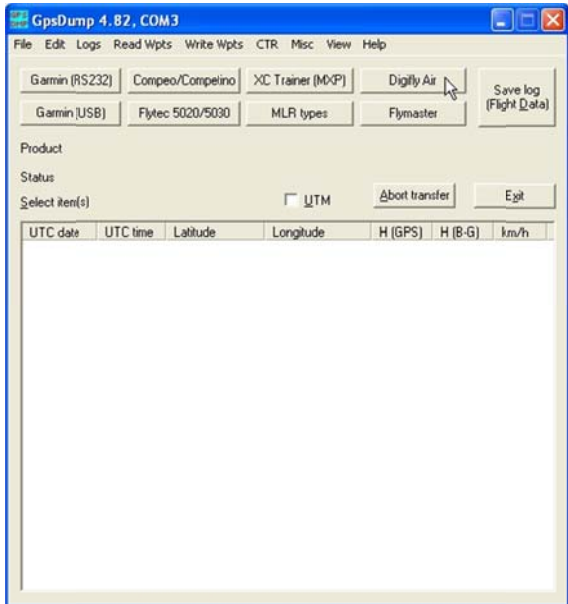





14.2 DIGIFLY AIRUPDATER SOFTWARE FOR FIRMWARE UPDATE (PC, MAC)

- When you buy a Digifly AIR, besides the FREE specialized management software and the possibility of creating FREE worldwide digital topographic maps, you will also get FREE firmware updates for life!
- The firmware on your Digifly instrument can be updated to new versions using the “AirUpdater” program available for Windows and Mac. This free software can be downloaded from our web site



- www.digifly.com and allows you to get new functions and improvements on your instrument.
- The firmware update works only with the USB cable. **Note:** it is **not** possible to update the firmware via the Bluetooth connection.

14.2.1 FIRMWARE UPDATE PROCEDURE







- 1) Make sure that your instrument's battery is fully charged. It is important!
- 2) Close all other PC/Mac programs that are running, including the antivirus & firewall.
- 3) Make sure that the instrument is turned off and connected with the USB cable to your computer.
- 4) Press and hold the  key first and hold it down, then simultaneously press and hold the  key and wait until the instrument emits a long acoustic “beep”. Now the instrument is turned on and is in “boot loader mode”, waiting for the firmware upload. **Note:** the screen will be totally blank at this point.
- 5) First release the  key and then the  key.
- 6) On your PC/Mac run the Digifly's firmware updating program "AirUpdater".
- 7) Set the COM Port (“Auto search”) and the speed (115200) should be automatically set, press the “Start” button, then select the firmware file (e.g. AirBt_410B_Gr_19.hex) and confirm.

Note: If you need to upload the same firmware version: right click on the Start button, click on "Force full firmware update" then select the firmware file and confirm.

- 8) The complete update procedure takes about 10 minutes; once finished, your computer will provide an acoustic and visible message, then the Air instrument will switch off automatically.

Important: if the update fails, the instrument's memory could be wiped, and in this case, it will not turn on. If this happens, the instrument may quickly discharge the battery BUT IT IS NOT BROKEN.

To restore it, it is necessary to reset it and, at the same time, to recall the "bootloader mode":

- Press and hold the 3   and  keys together.
- Wait 5 seconds, then release the  key; the instrument emits a long acoustic “beep”.
- First release the  key and then the  key. Now the instrument is turned on and it is in “boot loader mode”, waiting for the firmware upload. **Note:** the screen will be totally blank at this point.
- Resume from step 6) making sure that the “Set COM” is on “Auto search” and “Set speed” on “115200”.

15 DIGIFLY TELEMETRY: HIGH SPEED REAL TIME DATA OUTPUT (AIR-BT ONLY)

- With this fantastic feature, the AIR-BT can send, via Bluetooth, at a continuous high speed (10 times per second) and in real time, information (telemetry: all the information from its sensors) to external devices such as Smartphones, Tablets, PDAs, Car Navigators, Palms, Pocket PCs, etc. that have a software compatible to receive, decode and display the Digifly's telemetry data, such as **XCSoar**, **XCTrack** and **LK8000** (see paragraphs 15.3, 15.4, 15.5).

15.1 ACTIVATE THE DIGIFLY'S TELEMETRY DATA OUTPUT

- To enable the Digifly's telemetry output, set the **ADVANCED SETUP \ n. 26 BLUT** parameter to "ON", which activates the Bluetooth then set the correct telemetry type **ADVANCED SETUP \ n. 25 TELE**. **N.B.** Use "FL2" for **XCSoar** and **LK8000**; for **XCTrack** use "FL3".

15.2 TELEMETRY DATA SELECTION

- Select the telemetry data type with the **ADVANCED SETUP \ n. 25 TELE** parameter:
- TELE=CAR: GPS(\$GPGGA+\$GPRMC) sends telemetry once per second
- TELE=FL1: GPS(\$GPGGA+\$GPRMC) sends once per second and \$PDGFTL1, sends once per second.
- TELE=FL2: GPS(\$GPGGA,\$GPRMC) sends once per second and \$PDGFTL1 sends 10 times per second.
- TELE=FL3: LK8EX1 sends 10 times per second.
- TELE=FL4 and FL5: (reserved for future implementations).
- TELE=FL6: barometer in thousandths of mb in 6 digit hex "xxxxxx[CR][LF]" sent 10 times per second.
- TELE=FL7: barometer in hundreds of mb in 5 digit hex "PSR[SP]xxxxx[CR][LF]" sent 10 times per second.
- DATA COMMUNICATION SETTINGS: **115200 bauds**, no parity, 8 data bit, 1 stop bit
- The Nmea field "checksum" is composed by "*" and 2 hex digits representing the "exclusive OR"

\$GPGGA, 161229.487, 3723.2475, N, 12158.3416, W, 1, 07, 1.0, 9.0, M, , , ,0000*18<CR><LF>

Name	Example	Unit	Description
Message ID	\$GPGGA		GGA protocol header
UTC Position	161229.487		hhmmss.sss
Latitude	3723.2475		ddmm.mmmm
N/S Indicator	N		N=north or S=south
Longitude	12158.3416		Dddmm.mmmm
E/W Indicator	W		E=east or W=west
Position Fix Indicator	1		0=Fix not available 1=Fix available
Satellites Used	07		Range 0 to 12
HDOP	1.0		Horizontal Dilution of Precision
MSL Altitude	9.0	meters	
Units	M	meters	
Geoid Separation		meters	
Units	M	meters	
Age of Diff. Corr.		second	Null fields when DGPS is not used
Diff. Ref. Station ID	0000		
Checksum	*18		Nmea checksum
<CR><LF>			End of message termination

\$GPRMC, 161229.487, A, 3723.2475, N, 12158.3416, W, 0.13, 309.62, 120598, ,A*10<CR><LF>

Name	Example	Unit	Description
Message ID	\$GPRMC		RMC protocol header
UTC Position	161229.487		hhmmss.sss
Status	A		A=data valid or V=data not valid
Latitude	3723.2475		ddmm.mmmm
N/S Indicator	N		N=north or S=south
Longitude	12158.3416		dddmm.mmmm
E/W Indicator	W		E=east or W=west
Speed Over Ground	0.13	knots	
Course Over Ground	309.62	degrees	True
Date	120598		ddmmyy
Magnetic Variation		degrees	E=east or W=west
Mode	A		A=Autonomous, D=DGPS, E=DR
Checksum	*10		Nmea checksum
<CR><LF>			End of message termination

\$PDGFTL1,2025,2000,250,-14,45,134,28,65,382,153*3D<CR><LF>

Name	Example	Unit	Description
Baro Altitude QNE(1013.25)	2025	meter	2025 mt
Baro Altitude QNH	2000	meter	2000 mt
Vario	250	cm/sec	+2,50 m/s
Netto Vario	-14	dm/sec	-1,40 m/s
Indicated Air Speed	45	km/h	45 km/h
Ground Efficiency	134	ratio	13,4 : 1
Wind Speed	28	km/h	28 km/h
Wind Direction	65	degree	65 degree
Main Lithium Battery Voltage	382	0.01 volts	3,82 volts
Backup AA Battery Voltage	153	0.01 volts	1,53 volts
Checksum	*3D		Nmea checksum
<CR><LF>			End of message termination

15.3 DIGIFLY TELEMETRY DATA CONNECTION WITH XCSoAR (AIR-BT ONLY)

- The free **XCSoAR** software, running on an external device (e.g. Smartphone, Tablet, PDA, Car navigator, Pocket-PC, etc.), receives, decodes and displays the **Digifly Telemetry Data** sent in real time at high speed by the **AIR-BT** via Bluetooth.
- In order to use **XCSoAR** you must have already previously done (only once) the pairing procedure with the external device (see 13.2.1).
- It also requires that the **ADVANCED SETUP \ n. 26 BLUT** parameter is set to "ON" (Bluetooth enabled) and that the **ADVANCED SETUP \ n. 25 TELE** parameter is set to "FL2" (sending Digifly telemetry data enabled).
- The sequence of operations to use this software via Bluetooth is the following:
 - 1) In the **AIR-BT**, go to MENU \ "Telemetry BT"
 - 2) Run **XCSoAR** on the external device, follow the program's instructions as to how to connect to an external Info Box (in this case, your Digifly AIR).
 - Go to MENU \ CONFIGURATION \ DEVICES then choose one of the unassigned windows and select "Edit".
 - Click on "Port" and select "Digifly AIR nnn" (where "nnn" are the last 3 digits of your instrument's serial number), go to "Driver", select "Digifly Leonardo" and click on "Select" (see images below). They are now connected and the telemetry data transfer should be running.
 - 3) When the **AIR-BT** receives the confirmation that it is connected from the external device, it automatically exits from the "Telemetry BT" menu, returns to the current page of instruments, turns the Bluetooth icon on and activates the continuous transmission of real-time Digifly telemetry data at high speed.

In case of problems, press the  key on the **AIR-BT** to exit and try again.

- To correctly decode the Digifly telemetry, it is necessary (only once) to enter in the XCSoar "CONFIGURATION MENU", then "devices" and enable the Device Driver = "Digifly Leonardo" and Port = "Digifly AIR BT".
- If everything is correct, the "Monitor" page in XCSoar will display the telemetry data transmitted from the AIR-BT.
- For more info about the **XCSoar** software please visit their website www.xcsoar.org

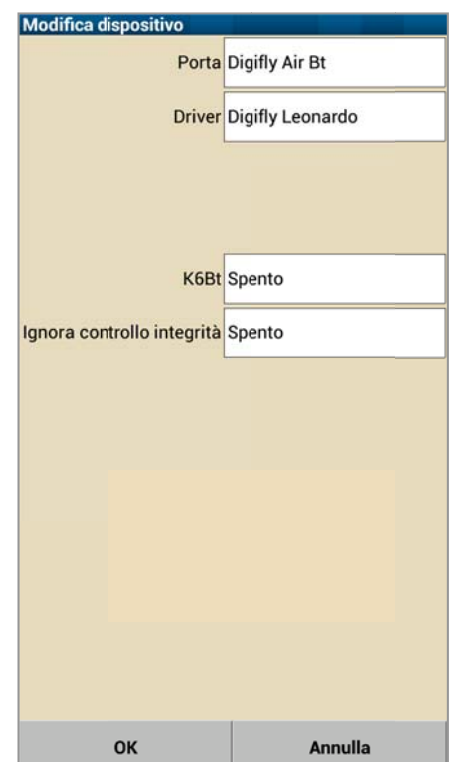
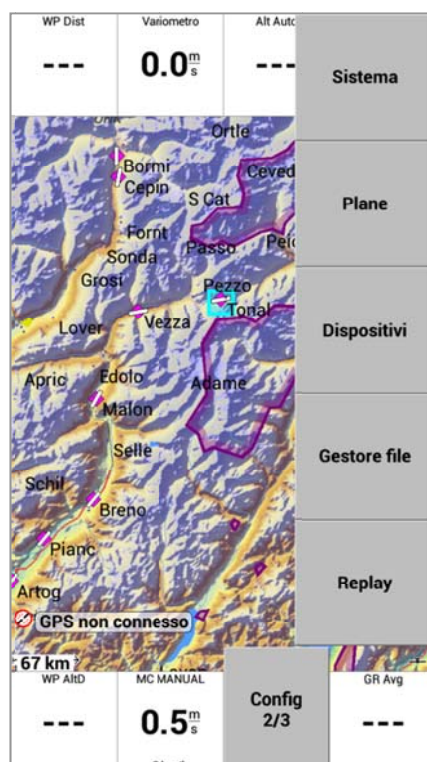
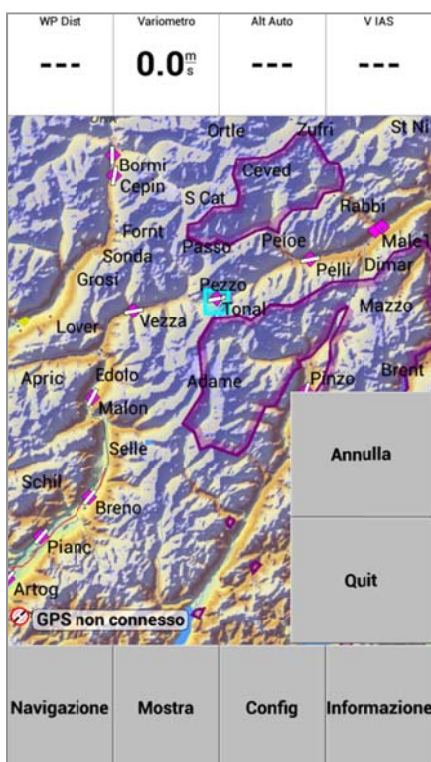

Monitor porta: Bluetooth Digify Air Bt

```

SPDGFTL1-17.76.13.0_375.38
SPDGFTL1-17.76.14.0_377.30
SPDGFTL1-17.76.15.0_377.3C
SPDGFTL1-17.76.15.0_375.3E
SPDGFTL1-17.76.17.0_375.3C
SPDGFTL1-17.76.18.0_375.33
SPDGFTL1-17.76.19.0_376.31
SGPRMC,162437.094,V,0.00,0.00,17
1113_N#4I
SGPGGA,162437.094,0.0_M,M,-4
0
SPDGFTL1-17.76.26.0_377.3C
SPDGFTL1-17.76.26.0_376.3D
SPDGFTL1-17.76.26.0_376.3D
SPDGFTL1-17.76.25.0_376.3E
SPDGFTL1-17.76.25.0_376.3E
SPDGFTL1-17.76.24.0_377.3E
SPDGFTL1-17.76.23.0_377.39
SGPRMC,162438.094,V,0.00,0.00,17
1113_N#4E
SGPGGA,162438.094,0.0_M,M,-4
0
SPDGFTL1-17.76.0.0_377.25
SPDGFTL1-17.76.2.0_377.27
SPDGFTL1-17.76.4.0_377.21
SPDGFTL1-16.77.6.0_376.22
SPDGFTL1-16.77.8.0_375.2F
SPDGFTL1-16.77.10.0_375.16
SPDGFTL1-16.77.12.0_375.14
SGPRMC,162439.094,V,0.00,0.00,17
1113_N#4F
SGPGGA,162439.094,0.0_M,M,-4
0
SPDGFTL1-17.76.15.0_375.13
SPDGFTL1-17.76.14.0_376.11
SPDGFTL1-17.76.13.0_375.15
SPDGFTL1-17.76.13.0_375.15
SPDGFTL1-17.76.13.0_376.16
SPDGFTL1-17.76.13.0_377.17
SPDGFTL1-17.76.12.0_376.17

```

Chiudi	Annulla	Riconnetti	Pausa
--------	---------	------------	-------

Dispositivi

A: GPS integrato & sensori
No dati

B: Digify Leonardo su Bluetooth Digify Air Bt
Connesso; Barometro; Airspeed; Variometro

C: Disabilitato
Disabilitato

D: Disabilitato
Disabilitato

E: Disabilitato
Disabilitato

F: Disabilitato
Disabilitato

Chiudi

Disable	Riconnetti	Download volo	
Modificare	Gestisci	Monitor	Debug

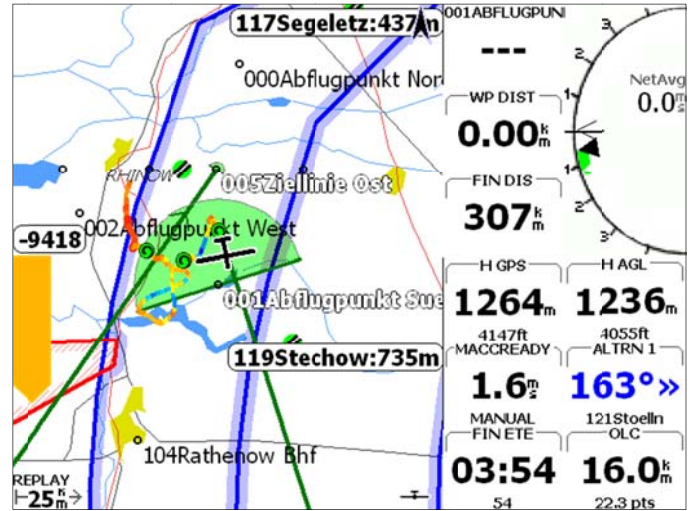

15.4 DIGIFLY'S TELEMETRY CONNECTION WITH XTRACK (AIR BT ONLY)

- The free **XCTrack** software, running on an external device (e.g. Smartphone, Tablet, PDA, Car navigator, Pocket-PC, etc.) receives, decodes and displays the Digifly's Telemetry Data sent in real time at high speed by the AIR-BT via Bluetooth.
- In order to use the **XCTrack** software, you must have already previously done (only once) the pairing procedure with the external device (see 13.2.1). It also requires that the **ADVANCED SETUP \ n. 26 BLUT** parameter is set to "ON" (Bluetooth enabled) and that the **ADVANCED SETUP \ n. 25 TELE** parameter is set to "FL3" (sending Digifly Telemetry data enabled).
- The sequence of operations to use this software via Bluetooth is the following:
 - 1) Go to the **AIR-BT's** MENU page, then to "**Telemetry BT**".
 - 2) Run the **XCTrack** software on the external device.
 - 3) When the **AIR-BT** receives the confirmation from the external device that they are connected, it automatically exits the "Telemetry BT" screen, returns to the current page of instruments, turns the Bluetooth icon on and activates the continuous transmission of real-time Digifly telemetry data at high speed.

In case of problems, press the  key on the **AIR-BT** to exit and try again.

- To correctly decode the Digifly's telemetry while using **XCTrack**, you need to go to "menu", "settings", then select the "sensors" sub-menu, then select "use external Bluetooth sensor" and finally -from the list- select your Digifly, which will be listed as Digifly AirXXX, where the "XXX" stand for the last 3 digits of your AIR's serial number; for example, "Digifly Air123". This procedure only needs to be done once.
- For more info about the **XCTrack** software please visit their website www.xctrack.org

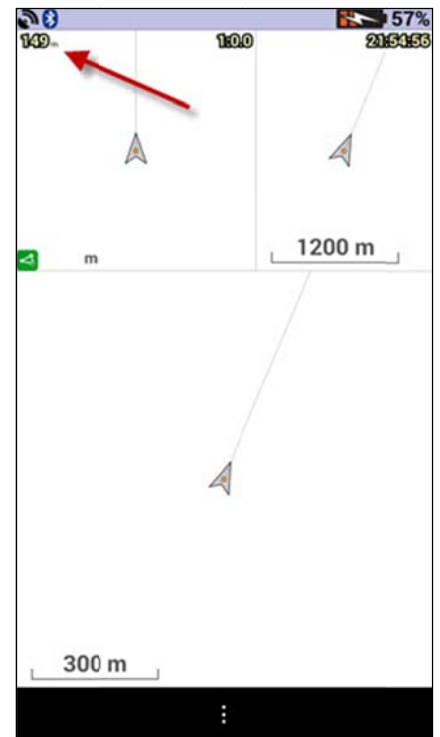
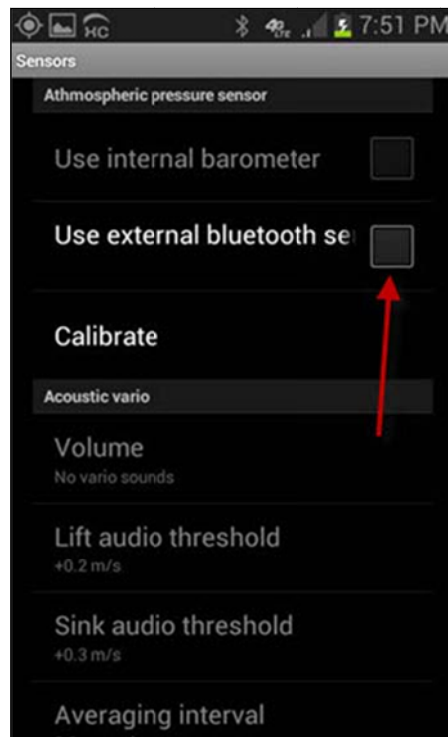
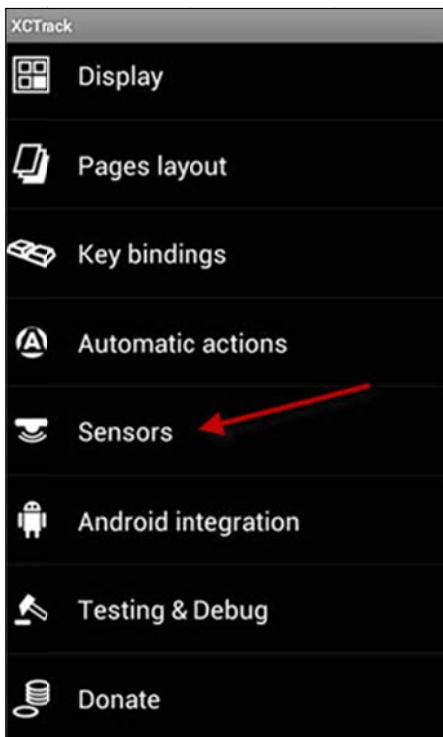

15.5 DIGIFLY TELEMETRY DATA CONNECTION WITH LK8000 (AIR-BT ONLY)

- The free **LK8000** software running on an external device (e.g. Smartphone, Tablet, PDA, Car Navigator, Pocket-PC, etc.) receives, decodes and displays the **Digifly's Telemetry Data** sent in real time at high speed by the **AIR-BT** via **Bluetooth**.

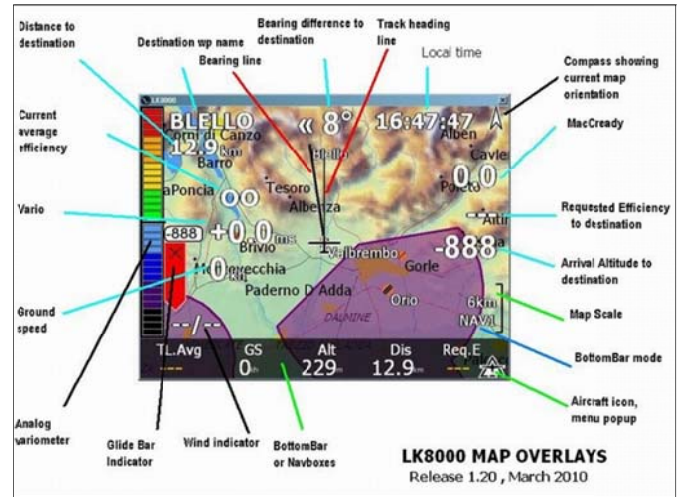

- In order to use the **LK8000** software you must have already previously done (only once) the pairing procedure with the external device (see 13.2.1). It also requires that the **ADVANCED SETUP \ n. 26 BLUT** parameter is set to "ON" (Bluetooth enabled) and that the **ADVANCED SETUP \ n. 25 TELE** parameter is set to "**FL2**" (sending Digifly Telemetry data enabled).

- The sequence of operations to use this software via Bluetooth is the following:
 - 1) On the **AIR-BT**, go to MENU "**Telemetry BT**".
 - 2) Run the **LK8000** software on the external device.
 - 3) When the **AIR-BT** receives from the confirmation that it is connected the external device, it automatically exits from the "Telemetry BT" menu, returns to the current page of instruments, turns the Bluetooth icon on and activates the continuous transmission of real-time Digifly telemetry data at high speed

In case of problems, press the  key on the **AIR-BT** to exit and try again.

- To correctly decode the Digifly's telemetry, it is necessary (only once) to enter in the LK8000 "configuration menu" and enable the Device Driver = "Digifly Leonardo" and Port = "Digifly AIR BT".
- If everything is correct, the "Monitor" page in LK8000 displays the telemetry data transmitted from the AIR-BT.
- For more info about the **LK8000** software please visit their website www.lk8000.it

15.6 DIGIFLY'S TELEMETRY CONNECTION WITH TOPHAT (AIR BT ONLY)

- Tophat is a free software developed for PC and Android; an XCSOAR clone, that can interface with your Digifly. You can download it at: www.tophatsoaring.org/Download.html

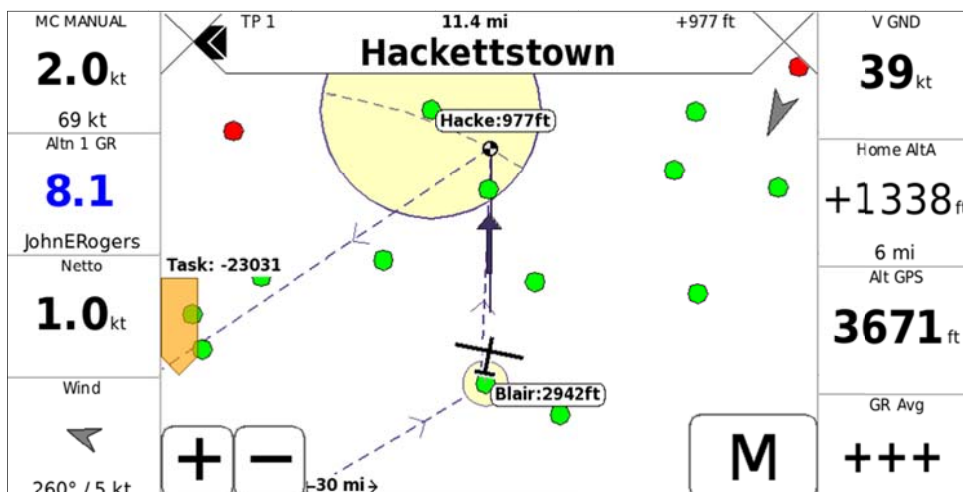

16 APPENDIX

16.1 DIGIFLY AIR STANDARD ACCESSORIES

- The Digifly AIR-SE and AIR-BT are shipped with the following standard accessories:
- Protective padded bag.
- Internal rechargeable lithium battery.
- Battery charger 5V 1000mA (110-220Vca 50-60Hz).
- USB PC cable for flights download, managing other functions and firmware updates directly from the Internet.

16.2 OPTIONAL ACCESSORIES

- The following optional accessories are available from Digifly:
- Integrated Anemometer (Airspeed Sensor - Pitot tube)
- Hang gliding vario mount
- Paragliding protective soft case

16.3 TECHNICAL FEATURES

16.3.1 STANDARD FUNCTIONS

- Graphic altimeter
- Altimeters up to 9,000m (29527ft)
- A1 altimeter with optional automatic synchro with GPS altitude.
- A2 altimeter automatically synchronizes with the altitude on take off
- A3 "thermal gain" altimeter automatic reset
- Above ground altimeter, when using the Topographic Maps functions
- Thermal Tutor with auto-zoom and real time thermal plotter with different thickness depending on the lift
- Thermal Assist with customizable size and scale, to better thermal coring.
- **10-Sensors Vario** (barometer + 9 sensors inertial platform) with **self-adaptive sensitivity** function
- Digital vario +/- 25 m/s (5000 ft/min)
- Analogue vario +/- 25 m/s (5000 ft/min)
- Vario integrator adjustable from 0 to 60 sec
- Net Vario (with optional Pitot tube)
- McCready and Equivalent McCready function (with optional Pitot tube)
- Total energy compensation (with optional Pitot tube)
- Acoustic vario with adjustable volume and tone levels plus vario simulator function
- Acoustic vario with "pre-thermal" function
- Acoustic vario with "auto-silence" function
- Airspeed IAS / TAS (with optional Pitot tube)
- Speed Difference (with optional Pitot tube)
- Speed to Fly (with optional Pitot tube)
- 3 adjustable polar curves (with optional Pitot tube)
- Barometer (range 300 to 1200mB) with user's calibration
- Constant battery monitoring.
- Date and time, with auto GPS synchro, chronometer, flight timer.

16.3.2 ADVANCED FUNCTIONS

- Inertial platform AHRS with 3-axis gyroscopes, 3 accelerometers and 3 magnetometers
- Three axis magnetic compass
- Three axis G-meter
- Pitch, Roll and Yaw indicator
- Integrated Digifly Flybox (sensor box) with high speed telemetry via Bluetooth to XCSoar, XCTrack, LIK8000, GpsDump, TTLiveTrack24 and many other free apps (BT models only).
- Intellifly function with automatic page switching feature.

16.3.3 GPS FUNCTIONS

- Integrated high sensitivity GPS receiver with 99 channels and 10hz
- Latitude, Longitude, Altitude GPS, Direction GPS (TRK), Ground Speed GPS
- Efficiency (Glide Ratio) related to the ground (with GPS ground speed)
- Wind speed and direction indicator (with GPS)
- Position, direction and distance of the last thermal
- HSI graphic navigation function
- "Follow Me" Navigation function
- "GOTO HOME" Navigation function
- "GOTO LANDINGS" and "GOTO NEAREST" Navigation functions
- Direction, distance, height, efficiency and time to the current Waypoint
- Direction, distance, height, efficiency and time to the GOAL
- Optimized navigation management with shortest path indications and Glide calculator
- Real Time Navigation Manager with "Skip Waypoint" and "Skip Start Time" function
- Automatic FAI cylinder turn point and Start Waypoint validation (visual and acoustic)
- Start Waypoint full management with indications of: start gate opening time, time to opening, estimated relative time to the Start cylinder, requested speed to arrive to the Start cylinder
- Automatic Start Waypoint display switching function
- 186 Competition Waypoints + 186 User Waypoints
- 12 Routes with 20 Waypoints on each Route
- Multi-flight logger, 3D recorder (flight data and GPS) with Auto-start and Auto-stop
- 100,000 data points flight recorder: from 1,800 hours (1 point per minute) to 30 hours (1 point per second)
- Up to 250 recordable flights.
- Controlled air spaces (CTR) management
- FREE worldwide digital multi-layer topographic Maps with vector and raster cartography
- Real time AGL altimeter (using the free topographic maps' elevation information)
- 3D Airspace manager

16.3.4 GENERAL SPECIFICATIONS

- Very high resolution, gray scale, graphic LCD display 320x240 pixels
- 13 Graphic screens from which 12 are completely configurable by the user with simple "drag & drop" technique using the graphical free software Digifly AirPages for PC and Mac
- Free Digifly AirTools vario management software for PC and Mac
- Compatible with GpsDump free software for PC, Mac and Android Smartphone
- Compatible with most competition software and with Online XC Contest programs
- USB (AIR SE and BT) and Bluetooth (AIR BT only) data communication
- Integrated Digifly Flybox (sensor box) with high speed telemetry via Bluetooth to XCSoar, XCTrack, LIK8000, GpsDump, TTLiveTrack24 and many other free apps (BT models only).
- Free Firmware updates via Internet
- FREE worldwide digital topographic maps

- 14 Languages for “Help” texts setup
- Adjustable units of measure
- MicroSD Memory Card slot
- Ready for installation of the optional Pitot tube and sensor kit
- Ready for installation of the optional GSM-GPRS LiveTracking kit
- Integrated battery charger via mini USB, which can use an external power supply, even during flight (with external power bank)
- Battery life 30 hours with its integrated high-capacity, rechargeable lithium battery
- Dimensions (H x L x D) 154mm x 90mm x 18mm
- Weight -with battery- 180g (0.4lb or 6.4oz)
- The Digifly AIR instruments are supplied with a protective case, rechargeable internal lithium battery, wall adapter charger (110-220Vca 50-60Hz) and USB cable
- **3-year warranty.**

16.4 MAIN SET UP MENU PARAMETERS

n.	Name	Description	Range	Default	Units
1	CTRS	display contrast setting	1 - 99	36	%
2	LANG	language selection	USR/ UK /ITA/ESP/DEU/FRA/CZE/HUN/PLN/GRK/TRK		
3	RECM	recorder mode selection	OFF/ALW/AUT	AUT	---
4	R.DS	meters variation start autorecorder	0.1 - 5	0.5	mt
5	R.TI	seconds variation start autorecorder	1 - 30	3	sec
6	RECR	recorder rate	1 - 60	3	sec
7	UTCO	time zone difference	-15/+15	2	hours
8	HOUR	time setting: hours	0 - 23	---	hours
9	MIN	time setting: minutes	0 - 59	---	min
10	DAY	date setting: day	1 - 31	---	days
11	MONT	date setting: month	1 - 12	---	months
12	YEAR	date setting: year	0 - 99	---	years
13	U-AL	altimeter units	MT/FT	MT	---
14	U-SP	speed units	KMH/MPH	KMH	---
15	U-DS	distance units	KM/MIL	KMH	---
16	PILO	pilot's name	6 characters	ABCDEF	---
17	GTYP	glider type	6 characters	ABCDEF	---
18	GID	glider ID	6 characters	ABCDEF	---
19	ELVM	elevation mode setting	0 - 3	0	---
20	ELVB	elevation base height setting	0 - 4000	0	mt
21	ELVS	elevation step setting	10 - 1000	100	mt
22	CTRM	CTR mode setting	0 - 1	0	---
23	CTRD	CTR distance warning (horizontally)	0 - 9999	400	mt
24	CTRH	CTR vertical separation warning	0 - 999	400	mt
25	A2AU	A2 altimeter automatic reset (to 0)	OFF/ON	ON	---
26	PG01	Page 1 mode	OFF/STD/USR	OFF	---
27	PG02	Page 2 mode	OFF/STD/USR	OFF	---
28	PG03	Page 3 mode	OFF/STD/USR	OFF	---
29	PG04	Page 4 mode	OFF/STD/USR	OFF	---
30	PG05	Page 5 mode	OFF/STD/USR	OFF	---
31	PG06	Page 6 mode	OFF/STD/USR	OFF	---
32	PG07	Page 7 mode	OFF/STD/USR	ON	---
33	PG08	Page 8 mode	OFF/STD/USR	ON	---
34	PG09	Page 9 mode	OFF/STD/USR	ON	---
35	PG10	Page 10 mode	OFF/STD/USR	ON	---
36	PG11	Page 11 mode	OFF/STD/USR	ON	---
37	PG12	Page 12 mode	OFF/STD/USR	ON	---
38	IFLY	enable intelligibly mode	OFF/CMP/XC	XC	---
39	A1SY	enable A1 - AGPS synchronizing	OFF/ON	ON	---

16.5 ADV-SETUP PARAMETERS MENU (ADVANCED SETUP)

n.	Name	Description	Range	Default	Unit
1	PITO	Pitot tube enable	OFF/IAS/TAS	OFF	---
2	SDIF	enable speed difference	OFF/ON	OFF	---
3	OFSP	Pitot tube offset calibration	0 - 4000	0	---
4	KIAS	airspeed calibration	50 - 200 %	100	%
5	KBAR	barometer calibration	+/- 20.0	0.0	mB
6	GCAL	AHRS calibration	0 - 4	0	
7	GPOS	AHRS spatial position	0 - 1 - 2	0	
8	EFF	real time average glide ratio	1 - 30	3	sec
9	EFFA	average glide ratio for HW calc	1 - 99	15	sec
10	POLA	polar selection	OFF/P1/P2/P3	OFF	---
11-12-13		P1-A P1-B P1-C	polar coefficient 1	xxx	---
14-15-16		P2-A P2-B P2-C	polar coefficient 2	xxx	---
17-18-19		P3-A P3-B P3-C	polar coefficient 3	xxx	---
20	MCRA	McCready average time	0.2 - 30	10.0	min
21	MCRE	McCready equiv. average time	0.1 - 3	0.4	sec
22	WSEN	wind calculator sensibility	3 - 15	5	---
23	CORD	lat. lon. GPS coordinate format	DMM/DMS/UTM/DDD	DMS	---
24	SKPW	enable skip waypoint shortcut	OFF/ON	OFF	---
25	TELE	telemetry output enable	OFF/CAR/FL1 ... FL7	OFF	---
26	BLUT	bluetooth module enable	OFF/ON	OFF	---

16.6 VARIOMETER SETUP PARAMETERS

n.	Name	Description	Range	Default	Units
1	V.UP	acoustic vario lift setting	0 - 2.00	00.10	m/s
2	V.PT	acoustic vario pre-thermal setting	0 - 1.50	00.50	m/s
3	V.DN	acoustic vario sink setting	0 - 25.00	02.50	m/s
4	PROF	acoustic vario profiles	FAS/STD/SFT/US1/US2/MAN	MAN	---
5	STYL	rhythm style tone in lift	0 - 2	1	---
6	MODH	frequency modulation in lift	1 - 30	4	---
7	PITC	tone rhythm in lift	1 - 8	4	---
8	UPHZ	base frequency in lift	500 - 1400	700	Hz
9	DWHZ	base frequency in sink	350 - 1000	600	Hz
10	RVAR	acoustic vario sensitivity	1 - 20	10	---
11	INTE	integrator vario delay	5 - 60	10	sec
12	DSEL	vario bargraph mode	0/1/2/3/4	0	---
13	TECM	total energy compensation mode	OFF/ON/FULL	OFF	---
14	TEC	total energy compensation value	0 - 100	50	%
15	TECA	total energy compensation average	0 - 99	80	---
16	CRUT	glide detect time threshold	2 - 20	15	sec
17	THET	thermal detect time threshold	1 - 30	2	sec
18	THEZ	thermal tutor zoom level	1 - 100	1	---
19	THEA	thermal assist zoom level	1 - 20	5	---
20	SIMV	vario simulator	OFF/ON/FULL	OFF	---
21	AUTV	automatic acoustic vario	OFF/ON/FULL	ON	---

Digifly Europe s.r.l.
Bologna
Italy
www.digifly.com
info@digifly.com

