

# FLYMASTER

# GPS *m*



## User Manual v.1.0

# IMPORTANT

All rights reserved.

Except as expressly provided herein, no part of this manual may be reproduced, copied, transmitted, disseminated, downloaded or stored in any storage medium, for any purpose without the express prior written consent of Flymaster Avionics Lda. herein Flymaster Avionics. Flymaster Avionics hereby grants permission to download a copy of this manual onto a hard drive or other electronic storage medium to be viewed and to print a copy of this manual or of any revision hereto, provided that such electronic or printed copy of this manual must contain the complete text of this copyright notice and provided further that any unauthorised commercial distribution of this manual or any revision hereto is strictly prohibited. Information in this document is subject to change without notice. Flymaster Avionics reserves the right to change or improve its products and to make changes in the content without obligation to notify any person or organisation of such changes or improvements. Visit the Flymaster Avionics website ([www.flymaster-avionics.com](http://www.flymaster-avionics.com)) for current updates and supplemental information concerning the use and operation of this and other Flymaster Avionics products. **Warning** It is the sole responsibility of the pilot to operate the aircraft in a safe manner, maintain full surveillance of all wing conditions at all times, and not become distracted by the Flymaster GPS M . Flymaster Avionics is not responsible for any damages resulting from incorrect or no data provided by the Flymaster GPS M . Flight safety is the sole responsibility of the pilot. It is unsafe to operate the Flymaster GPS M while in the air. Failure by the pilot equipped with a Flymaster GPS M to pay full attention to the aircraft and conditions while wing could result in accident with property damage and/or personal injury.

## Índice

<b>Tech Specs</b> .....	<b>8</b>
<b>Overview</b> .....	<b>9</b>
<b>FLARM ANTENNA</b> .....	<b>10</b>
Warning: .....	10
Installation - .....	10
Antenna cap - .....	11
<b>First Steps</b> .....	<b>12</b>
<b>Reset and “recovery mode”</b> .....	<b>13</b>
Hardware Reset .....	13
Enter “recovery mode” .....	14
<b>Charging and battery management</b> .....	<b>15</b>
<b>Check battery status</b> .....	<b>16</b>
How to preserve the battery lifespan.....	17
Charging is easy .....	17
Avoid extreme ambient temperatures .....	17
<b>Keys and User Interface</b> .....	<b>19</b>
Main menu navigation keys .....	19
Enter/change values in Sub-menus .....	20
Setting the volume .....	21
Zoom and pan map object .....	21
<b>Default Pages</b> .....	<b>22</b>
Page 1 – Main Page.....	22
Page 2 – Airspace.....	23
Page 3 – Thermal .....	24
Page 4 –Route .....	25
Page 5 – Roads .....	26
Page 6 – Section (Cut-side view) .....	27
<b>Available data fields</b> .....	<b>28</b>
Above Toff .....	28
Abs.Pressure.....	28
Active waypoint.....	28
AGL .....	28
Alt.Gain.....	28
Alt.Gain/Loss .....	28
Alt.to CTR.....	28
Altitude.....	28
Altitude2.....	28

Arrival Next.....	28
Ave.Speed.....	28
Ave.Vario .....	28
Ave.ROT.....	28
Battery.....	28
Bearing .....	28
Ceiling.....	28
Compass .....	28
CTR Name.....	28
CTR Status .....	28
Cur.G.R. ....	28
Date .....	28
Dist.CTR .....	28
Dist.Edge .....	28
Dist.Line.....	28
Dist.Next.....	28
Dist.Thermal .....	28
Dist.Toff.....	29
Dur.....	29
Flight Level .....	29
Floor .....	29
G-Force .....	29
G.R.Next .....	29
G.R.Toff .....	29
GPS Alti.....	29
Ground .....	29
Heading .....	29
Latitude .....	29
Longitude .....	29
Max. Altitude.....	29
Max. Climb .....	29
Max. Sink .....	29
Max.G .....	29
Max.Speed.....	29
Min. Altitude .....	29
Odometer.....	29
Speed.....	29
Thermal top.....	29
Thrml.Perfo. ....	29
Time.....	29
Trans.G.R. ....	29
TTD .....	29
Turnpoint size.....	29
Vario .....	29
Wind Dir. ....	30
Wind Speed .....	30
<b>Objects (Graphical Elements).....</b>	<b>31</b>
<b>Battery .....</b>	<b>31</b>
<b>Volume indicator .....</b>	<b>31</b>
<b>GPS.....</b>	<b>31</b>
<b>Vario .....</b>	<b>31</b>
<b>Navigation wheel.....</b>	<b>32</b>
Navigation Arrows.....	32
Thermal Ball .....	33
Wind Flag.....	34

Profile Widget .....	34
<b>Map Layer Selection .....</b>	<b>35</b>
Airspace .....	35
Route .....	37
Roads .....	38
Wind Arrow .....	38
<b>Compass.....</b>	<b>39</b>
<b>Waypoints/Route.....</b>	<b>40</b>
Add a waypoint to the Route - .....	40
Insert New WP - .....	40
Edit waypoint - .....	40
Delete Waypoint - .....	41
Delete all waypoints - .....	41
Go to point - .....	41
Edit route - .....	41
Load waypoints from file – .....	41
<b>Nearby landings .....</b>	<b>42</b>
<b>Route Navigator.....</b>	<b>43</b>
<b>Nearby Airspaces.....</b>	<b>44</b>
Airspace detail.....	45
<b>Flight Log .....</b>	<b>46</b>
Generate IGC.....	46
Delete Flight .....	46
Delete all flights.....	46
<b>Device settings .....</b>	<b>47</b>
Factory settings - .....	47
Reset Now – .....	47
On Landing - .....	47
User:.....	47
SN: Serial number .....	47
Battery: .....	47
Charging mode .....	47
Charge up time: .....	47
Firmware:.....	47
Cur: .....	47
Diag:.....	47

3.000A or other value: .....	47
<b>Set Altimeter</b> .....	<b>48</b>
QNH - .....	48
Get from GPS - .....	48
<b>Time</b> .....	<b>49</b>
Vario integrator - .....	49
UTC offset - .....	49
<b>Alerts</b> .....	<b>50</b>
Turnpoint complete- .....	50
Airspace alarm - .....	50
Altitude alarm - .....	50
<b>Airspace settings</b> .....	<b>51</b>
CTR Distance Threshold: .....	51
CTR alt. Threshold:.....	51
Ignore above: .....	51
Ref. altitude:.....	51
Enabled: .....	51
Grey lines: .....	51
Source: .....	51
<b>Airspace classes</b> .....	<b>52</b>
<b>Trace</b> .....	<b>53</b>
Enabled: .....	53
Auto Zoom: .....	53
Zoom level:.....	53
Grey lines: .....	53
Track up: .....	53
<b>Screen</b> .....	<b>54</b>
Contrast .....	54
Disable triggers:.....	54
Inverse titles:.....	54
<b>Language units</b> .....	<b>55</b>
Language: .....	55
Altitude units:.....	55
Rate of Climb Units.....	55
Speed Units .....	55
Distance units.....	55

Internal Temperature: .....	55
Coordinates: .....	55
<b>FLARM</b> .....	<b>56</b>
<b>Calibrate Compass</b> .....	<b>57</b>
<b>Pages</b> .....	<b>58</b>
Disable Page .....	59
<b>Navigation settings</b> .....	<b>60</b>
Datum - .....	60
Angle – .....	60
Sort WP by Distance: .....	60
<b>Vario acoustics</b> .....	<b>61</b>
Sink Threshold - .....	61
Climb Threshold -.....	61
Sink Alarm - .....	61
Base Frequency- .....	62
Increments- .....	62
Cadence -.....	62
Buzzer - .....	62
Damper - .....	63
Dynamic Frequency- .....	63
<b>Advanced Settings</b> .....	<b>64</b>
Auto Silent- .....	64
Start Speed -.....	64
<b>GPS</b> .....	<b>65</b>
GPS satellite status page:.....	65
<b>Flymaster Instrument Manager Software</b> .....	<b>66</b>
Automatic firmware update - .....	66
Main Screen and tools .....	67
<b>Pages Layouts data fields and objects</b> .....	<b>68</b>
Customizing datafields and objects.....	69
Page Triggers .....	70
Manual firmware update.....	71

## Tech Specs

Display Type.....	Grayscale: 320x240px
Battery Capacity (Lithium-Ion).....	9000mAh
Autonomy.....	Usually +35 hours (environment conditions may alter this value)
Pressure Sensor.....	High resolution barometric sensor 10 – 1200 mbar
Audio.....	On board piezo system for vario and alerts
Memory expansion.....	Micro SD card ( 16 Gb already included)
GPS.....	72-channel BeiDou, Galileo, GLONASS, GPS /
Microprocessor.....	Microprocessor with proprietary RTOS
FLARM®.....	Flarm ready with optional Flarm beacon
Native USB Type C Connection.....	Allows connection to the PC
Battery Charging.....	From wall adapter or standard usb port
Firmware update by USB (upgrades are free)	
Size.....	152x90x18 mm
Weight.....	200g



## Overview



## FLARM ANTENNA

### **Warning:**

The Flymaster uses an external antenna, which has been tuned to the Flarm board circuit, especially for the band used. Although it can be considered annoying when taking off, it is an essential element for the system to work for the distances required by Flarm and which we consider to be ideal for seeing and being seen by other aircraft. The antenna included with the instrument is engraved with Flymaster branding to avoid any swapping or confusion. Any antenna other than the one sent, can lead to a malfunction of the Flarm system, leading the pilot to run the risk of being "invisible" to other aircraft and being subject to a potential accident.

**Installation** - Be sure to install the antenna, tightening it to the end of the thread securely. the tightening must be done in a clockwise direction.





**Antenna cap** - When the pilot does not want or does not need to fly with the Flarm antenna, must place the rubber cap (supplied) to cover the antenna socket.

## First Steps

1.

We recommend the reading of the following documents:

- Warranty terms and conditions.
- Complete user manual of your instrument.

To do that, please use the following links:

[https://dnl.flymaster.net/Flymaster\\_Standard\\_Limited\\_Warranty\\_EN.pdf](https://dnl.flymaster.net/Flymaster_Standard_Limited_Warranty_EN.pdf)  
<https://www.flymaster.net/downloads>

2.

Create a Flymaster Cloud account if you don't already have one.

After the account creation go to:

<https://livetrack360.com/login>

3.

Register the instrument in your account.

<https://livetrack360.com/devices/register>

4.

Install "Flymaster Instrument Manager" to manage your Vario M or GPS M.

F.I.M. will allow you to send new airspaces to the instrument, sending waypoints, building page layouts, update firmware, sync to Flymaster Cloud Flights, etc.

<https://www.flymaster.net/downloads>

## Reset and “recovery mode”

### *Hardware Reset*



If for some reason your instrument becomes unresponsive you can force a reset to force his reboot.

Press the power together with the menu/esc button at the same time for 2 or 3 seconds and release.

After releasing the buttons, the instrument should reboot.

**Enter “recovery mode”**



If for some reason your instrument does not start and keeps rebooting without any apparent reason, it's possible to put it in “recovery mode” so the firmware can be restored via Flymaster Instrument Manager.

Check the Youtube video link bellow, that explains how to do it.



<https://youtu.be/YMSvr8MNkMc>



## Charging and battery management

Flymaster GPS M has an advanced battery power management system, which gives the pilot accurate information about the battery state, as well as the charging time and battery remaining time.

To charge the Flymaster GPS M battery we recommend the usage of the supplied wall charger and USB cable via USB Type-C port.

Original Flymaster accessories are recommended in order to avoid damage to the power management system.

Charging, and battery status information is shown on both the power up screen and the settings info page.

When Flymaster GPS M is connected to a power supply (wall charger or via USB cable), the instrument will show the time remaining to full charge.

Use the supplied wall power supply to fully charge the instrument.

Note: Charging the instrument with high ambient temperatures should be avoided. Such action can cause the battery to overheat and affect the battery health.



## Check battery status

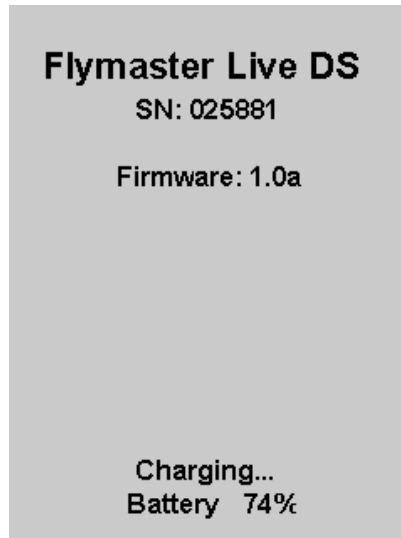

GPS M is charging turned off

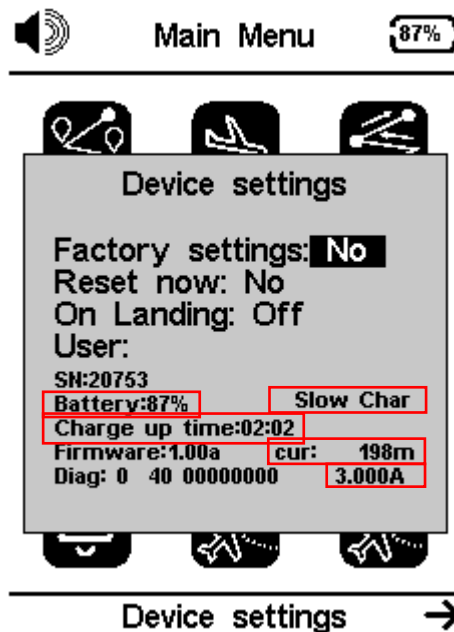

GPS M is charging turned on

Go to Menu -> Device settings

- Battery – Actual battery percentage
- Slow char or Quick Char
- Charge up Time – Time to achieve full charge
- Cur: Charging/discharging current
- 3.000A - Battery capacity



### ***How to preserve the battery lifespan***

All Flymaster instruments use Lithium-Ion batteries. Compared with traditional battery technology, lithium-ion batteries charge faster, last longer, and have a higher power density for more battery life in a lighter package.

The Flymaster lithium-ion battery uses fast charging to quickly reach 80% of its capacity, then switches to slower trickle charging. The amount of time it takes to reach that first 80% will vary depending on your settings and which instrument you're charging. This combined process not only lets you get out flying sooner, but it also extends the lifespan of your battery.

### ***Charging is easy***

Charge your Flymaster lithium-ion battery whenever you want. There's no need to let it discharge 100% before recharging. Flymaster lithium-ion batteries work in charge cycles. You complete one charge cycle when you've used (discharged) an amount that equals 100% of your battery's capacity - but not necessarily all from one charge. For instance, you might use 75% of your battery's capacity one day, then recharge it fully overnight. If you use 25% the next day, you will have discharged a total of 100%, and the two days will add up to one charge cycle. It could take several days to complete a cycle. The capacity of any type of battery will diminish after a certain amount of recharging. With lithium-ion batteries, the capacity diminishes slightly with each complete charge cycle. Flymaster lithium-ion batteries are designed to hold at least 80% of their original capacity for a high number of charge cycles, which varies depending on the instrument.

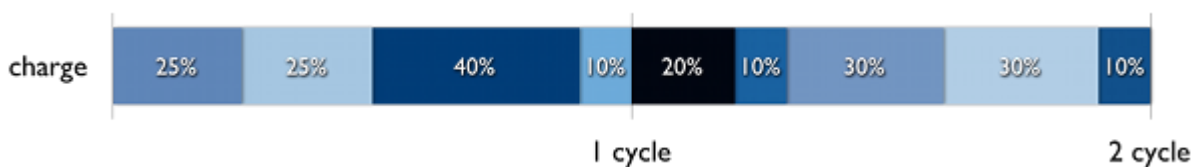

### ***Avoid extreme ambient temperatures***

Your instrument is designed to perform well in a wide range of ambient temperatures, with 5° to 25° C as the ideal comfort zone. It's especially important to avoid exposing your instrument to ambient temperatures higher than 35° C, which can permanently damage battery capacity. That is, your battery won't power your device as long on a given charge. Charging the device in high ambient temperatures can damage it further. Even storing a battery in a hot environment can damage it irreversibly. When using your device in a very cold environment, you may notice a decrease in battery life, but this condition is temporary. Once the battery's temperature returns to its normal operating range, its performance will return to normal as well. Store it half-charged when you store your instrument long term.

If you want to store your device long term, two key factors will affect the overall health of your battery: the environmental temperature and the percentage of charge on the battery when it's powered down for storage. Therefore, we recommend the following:

- Do not fully charge or fully discharge your instrument's battery - charge it to around 50%. If you store a device when its battery is fully discharged, the battery could fall into a deep discharge state, which renders it incapable of holding a charge. Conversely, if you store it fully charged for an extended period of time, the battery may lose some capacity, leading to shorter battery life.
- Place your instrument in a cool, moisture-free environment that's less than 32° C.
- If you plan to store your device for longer than six months, charge it to 50% every six months.

## Keys and User Interface

### *Main menu navigation keys*



Use cursor buttons to choose the desired operation. Push enter button to confirm and enter the Sub-menus.

## Enter/change values in Sub-menus

Waypoints	Route
D01151 D L	D01151 D L
D02145 D L	T10095 GR 3.6
D03124 D L	G11062 G 34.7
G01095 G	T11083 VID 34.0
G02042 G	
G03035 G	
G04067 G	
G05042 G	
G06062 G	
G07060 G	
0000 Total: 72.3	

<b>Add WP to Route</b>
Insert New WP
Edit WP
Delete WP
Delete All Waypoints
Go to Point
Edit Route



- Press **UP** and **DOWN** cursor buttons to chose an option in a list menu.
- Press **UP** and **DOWN** cursor buttons to change value.
- Press **ENTER** to accept the value and skip to next.
- Long press **ENTER** to skip to next line.

Waypoints	Route
D01151 D L	D01151 D L
D02145 D L	T10095 GR 3.6
D03124 D L	G11062 G 34.7
G01095 G	T11083 VID 34.0
G02042 G	
<b>G03035 G</b>	
G04067 G	
G05042 G	
G06062 G	
G07060 G	
0000 Total: 72.3	

Name: <b>G03035 G CHAVES</b>
Altitude: 354m
29 N 629009
4623470
Landing: No

## Setting the volume

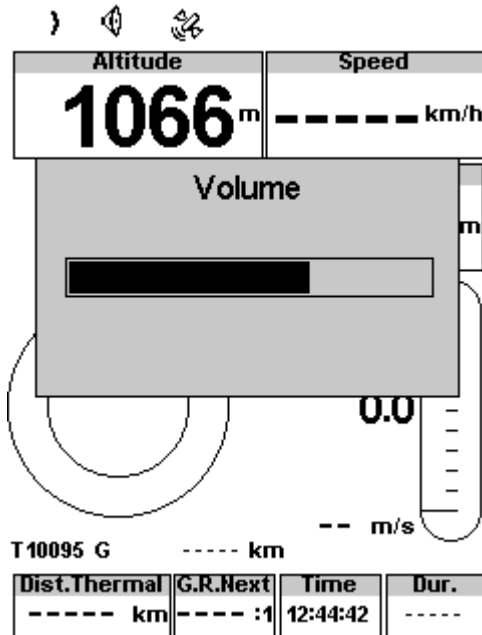

- 1 – Press (short) sound button
- 2 – Left and right cursor buttons to change the volume
- 3 – Press ENTER to confirm

## Zoom and pan map object



- In any layout that contains a Map (road, airspace or route) object is possible to Zoom.
- Press (long) zoom button. Zoom mode is shown over the map object, indicating that the zoom mode is active.
- Use UP button to ZOOM IN or DOWN button to ZOOM OUT. The zoom mode will exit automatically after 5 seconds.

## Default Pages

GPS M allows you to design up to 8 pages in portrait mode and 8 in landscape mode, using the Flymaster Instrument Manager. In flight you can change pages manually using the ENTER button. On the following pages we will show which pages Flymaster designed and which will be default to the instrument. The description of each data field is available in this user manual in the section “available data fields”. The description of each object is available in this user manual in the section “objects”.

### Page 1 – Main Page

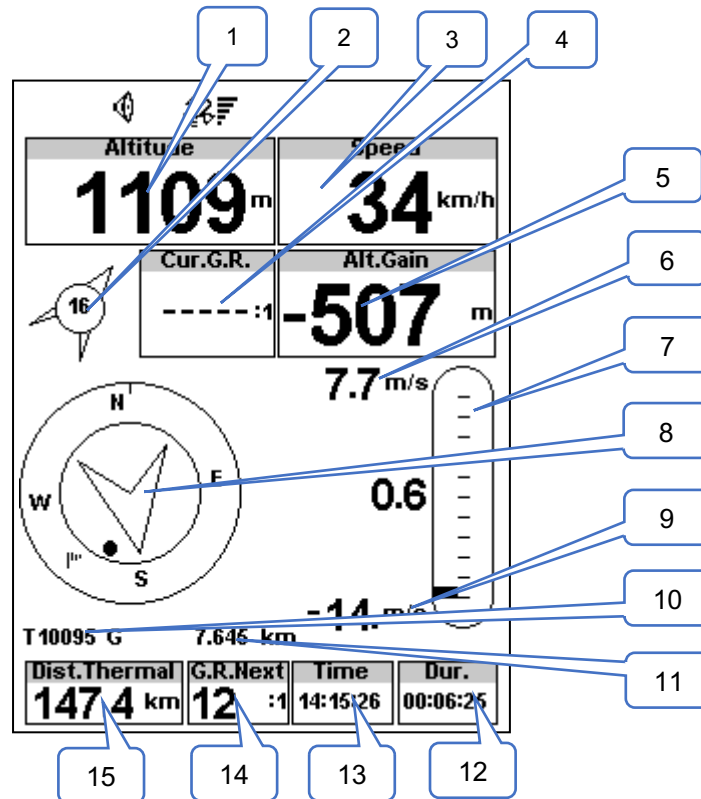

- 1 – [Altitude](#)
- 2 – Wind arrow
- 3 – [Speed](#)
- 4 – [Current glide ratio](#)
- 5 – [Altitude gain](#)
- 6 – [Max. Climb](#)
- 7 – [Vario](#)
- 8 – [Navigation wheel](#)
- 9 – [Max. Sink](#)
- 10 – [Active waypoint](#)
- 11 – [Dist. Edge](#)
- 12 – [Flight duration](#)
- 13 – [Time](#)
- 14 – [Glide ratio to next](#)
- 15 – [Dist. Thermal](#)

## Page 2 – Airspace

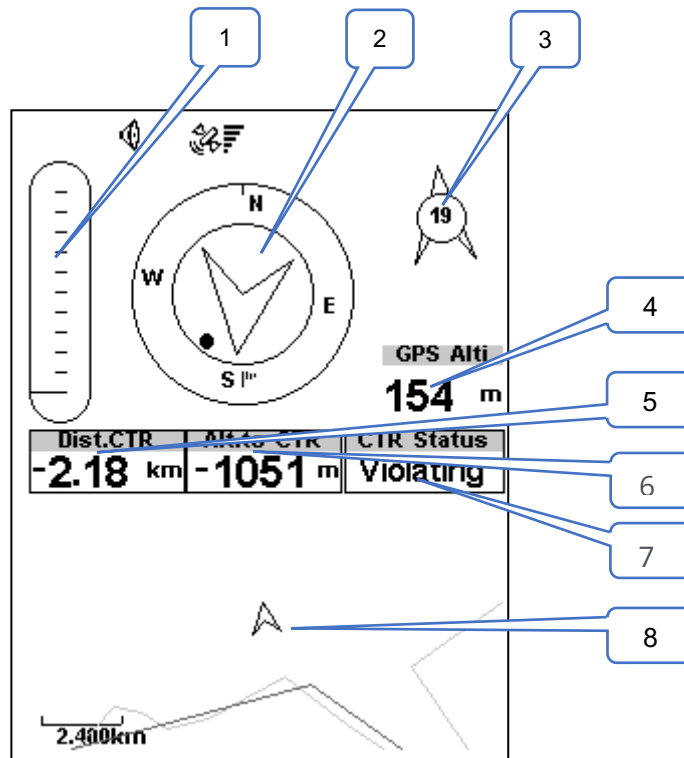

- 1 – [Vario](#)
- 2 – [Navigation wheel](#)
- 3 – Wind arrow
- 4 – [GPS Altitude](#)
- 5 – [Distance to CTR](#)
- 6 – [Altitude to CTR](#)
- 7 – [CTR Status](#)
- 8 – [Map \(airspace\)](#)

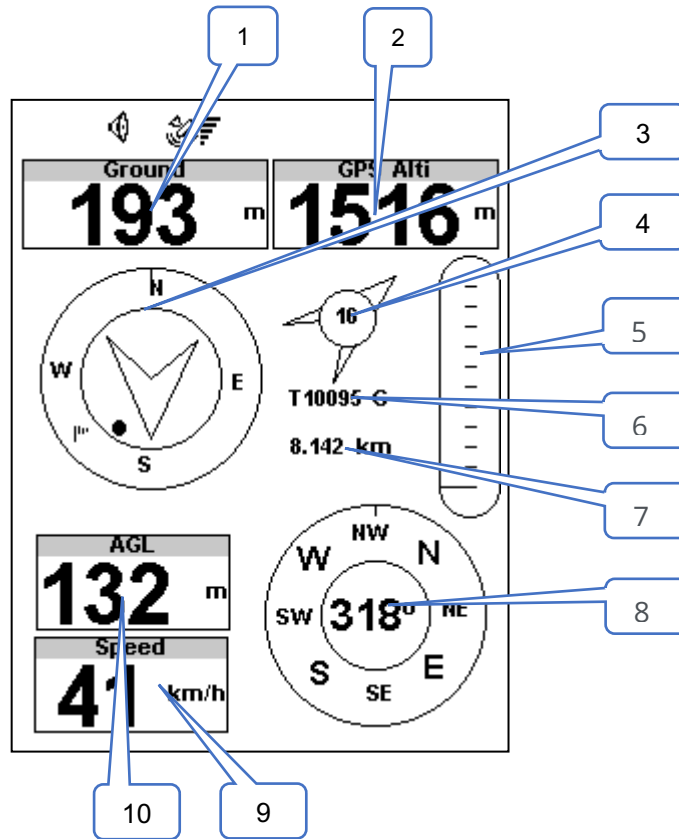

- 1 – [Ground altitude](#)
- 2 – [GPS Altitude](#)
- 3 – [Navigation wheel](#)
- 4 – Wind arrow
- 5 – [Vario](#)
- 6 – [Active waypoint](#)
- 7 – [Dist. Edge](#)
- 8 – [Compass](#)
- 9 – [Speed](#)
- 10 – [AGL](#)



**Page 4 –Route**

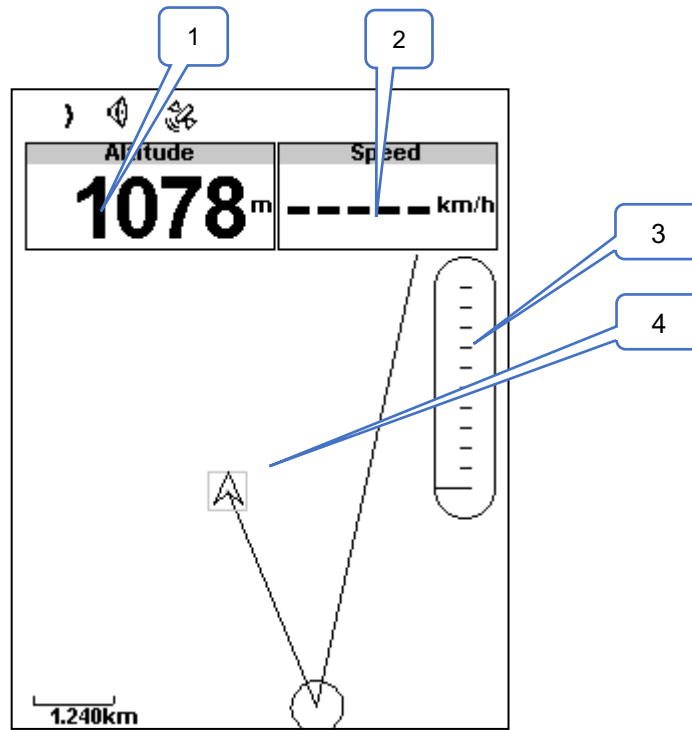

- 1 – [Altitude](#)
- 2 – [Speed](#)
- 3 – [Vario](#)
- 4 – [Map \(route\)](#)

**Page 5 – Roads**

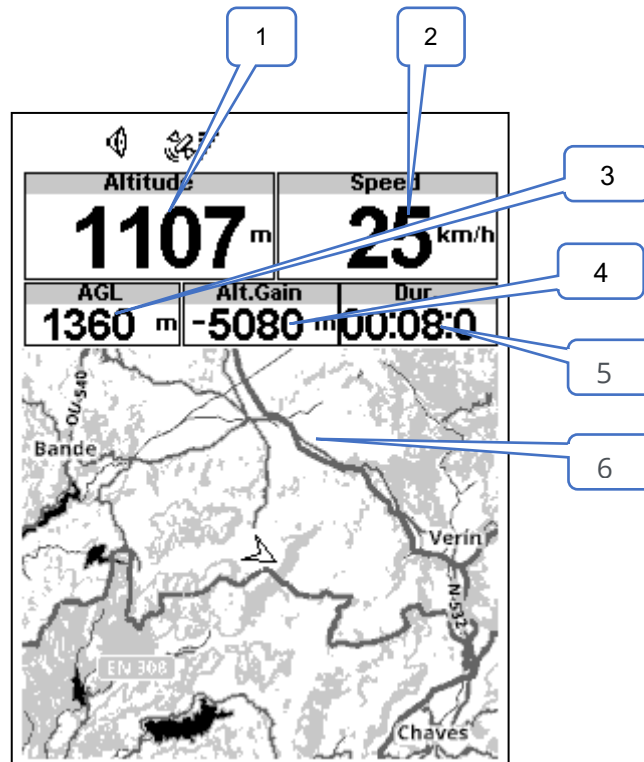

- 1 – [Altitude](#)
- 2 – [Speed](#)
- 3 – [AGL](#)
- 4 – [Altitude gain](#)
- 5 – [Flight duration](#)
- 6 – [Map \(roads\)](#)

## Page 6 – Section (Cut-side view)

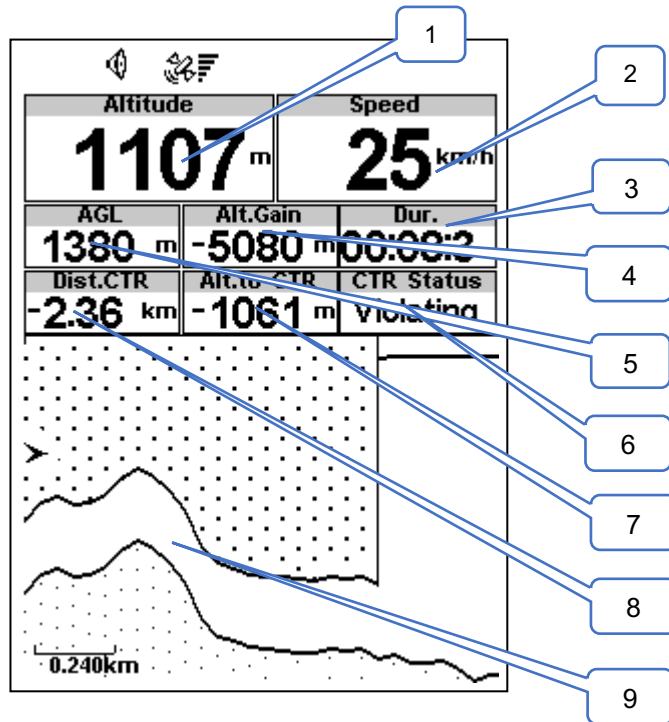

- 1 – [Altitude](#)
- 2 – [Speed](#)
- 3 – [Flight duration](#)
- 4 – [Altitude gain](#)
- 5 – [AGL](#)
- 6 – [CTR Status](#)
- 7 – [Altitude to CTR](#)
- 8 – [Distance to CTR](#)
- 9 – [Cut-side view](#)

# FLYMASTER

## GPS<sup>m</sup>

### Available data fields

<b>Above Toff</b>	Altitude above takeoff is the altitude over the flight starting point.
<b>Abs.Pressure</b>	Absolute atmospheric pressure value in Pascals.
<b>Active waypoint</b>	Active turnpoint name.
<b>AGL</b>	Altitude above ground current location, using GPS altitude as reference.
<b>Alt.Gain</b>	Altitude Gain. Altitude gained in current thermal.
<b>Alt.Gain/Loss</b>	Altitude Gain/Loss. When at the top of the thermal displays the altitude gained from the base of the thermal, else displays the altitude lost since reaching the top of thermal.
<b>Alt.to CTR</b>	Altitude to CTR shows altitude to controlled airspace, a negative number indicates we must sink to come out of controlled airspace.
<b>Altitude</b>	Current altitude. This altitude is calculated based on the barometric pressure and depends on the QNH value.
<b>Altitude2</b>	Second Altimeter which can be set independently to the main altimeter.
<b>Arrival Next</b>	Estimated arrival height above the next waypoint. This means that wind, day quality and glider performance are used in the calculations.
<b>Ave.Speed</b>	Average ground speed calculated using a filter to show a smoothed speed, eliminating erratic speed changes due to glider pitching, etc.
<b>Ave.Vario</b>	Average Vario calculated using an integration time constant in order to indicate smoother climbing rates.
<b>AveROT</b>	Average rate of turn in degrees per second.
<b>Battery</b>	Shows battery strength as a percentage of complete charge
<b>Bearing</b>	Current bearing in degrees.
<b>Ceiling</b>	Shows the upper altitude of the airspace causing the warning, i.e. airspace that you are violating or close to violating.
<b>Compass</b>	Angle between the magnetic North and the instrument.
<b>CTR Name</b>	Name of the airspace causing warning or violation.
<b>CTR Status</b>	Status message of airspace, will show "Violating" when in controlled airspace, "Imminent Alt" when close to entering airspace vertically or "Pos.Imminent" when close to entering airspace horizontally.
<b>Cur.G.R.</b>	Current glide ratio calculated using the average vario value, and average ground speed.
<b>Date</b>	Current date. This value is automatic set when the device gets a valid GPS Signal
<b>Dist.CTR</b>	Distance to controlled airspace. When more than one airspace area is in range the closest will be shown. When inside an airspace area the distance shown is to the closest edge.
<b>Dist.Edge</b>	Dist.Edge
<b>Dist.Line</b>	Distance to Line. Shortest distance to the waypoint line circle. Distance line corresponds to the Distance Next minus the waypoint radius.
<b>Dist.Next</b>	Distance to Next. Shortest distance to the waypoint center. Distance next corresponds to the Distance Line plus the waypoint radius.
<b>Dist.Thermal</b>	Shortest distance to last thermal core (thermal dot).

<b>Dist.Toff</b>	Distance to take off is the distance between the current point and the flight starting point.
<b>Dur.</b>	Flight Duration. Duration of the current flight.
<b>Flight Level</b>	Current altitude in hundreds of feet, based on a fixed QNH of 1013.25hPa.
<b>Floor</b>	Shows the lower altitude of the airspace causing the warning, i.e. airspace that you are violating or close to violating.
<b>G-Force</b>	Current G-Force being experienced by the pilot when using the Heart-G sensor.
<b>G.R.Next</b>	Glide Ratio to Next. Necessary glide ratio to reach the next turn point.
<b>G.R.Toff</b>	Glide ratio to takeoff. Necessary glide ratio to reach the take off.
<b>GPS Alti</b>	Altitude reported by the GPS.
<b>Ground</b>	Height of the ground at current location.
<b>Heading</b>	Heading in degrees returned by GPS.
<b>Latitude</b>	Current position latitude according to the format defined in the settings menu.
<b>Longitude</b>	Current position longitude according to the format defined in the settings menu.
<b>Max. Altitude</b>	Maximum altitude reached during current flight. This is based on barometric altitude.
<b>Max. Climb</b>	Once a flight has started, it shows the maximum rate of climb encountered during the flight. This value uses the instantaneous rate of climb. This value is reset when the instrument is switched off.
<b>Max. Sink</b>	Once a flight has started, it shows the maximum sink encountered during the flight. This value uses the instantaneous vario. This value is reset when the instrument is switched off.
<b>Max.G</b>	Max Gforce reached during flight
<b>Max.Speed</b>	Maximum Speed (returned by GPS) reached during the flight. When the instrument is switched off this value is reset back to zero.
<b>Min. Altitude</b>	Minimum altitude reached during current flight. This is based on barometric altitude.
<b>Odometer</b>	Distance travelled in the current flight
<b>Speed</b>	Indicates ground speed. The speed is only available when the GPS receiver has a valid signal.
<b>Thermal top</b>	The highest point reached during the current thermal.
<b>Thrml.Perfo.</b>	Performance of the most recent thermal showing average rate of climb in most recent thermal.
<b>Time</b>	Current local Time. This value is automatic revised when the device gets a valid Gps Signal. (see Note 2)
<b>Trans.G.R.</b>	Glide ratio during transition. Average glide ratio during transitions between thermals.
<b>TTD</b>	Time to destination
<b>Turnpoint size</b>	Radius of the active turnpoint.
<b>Vario</b>	Instant vario value.

<b>Wind Dir.</b>	Wind direction in degrees, calculated from gps when drifting.
<b>Wind Speed</b>	Calculated wind speed using GPS speed.

## Objects (Graphical Elements)

Graphical elements are characterized by providing information in a graphical way. Most of the graphical elements have fixed dimensions, although their position can be altered.

### ***Battery***



The Battery Element provides a graphical indication of the current battery level. This element has fixed dimensions.

### ***Volume indicator***



The volume indicator element provides a graphical indication of the current volume level. This element has fixed dimensions.

### ***GPS***



The GPS Element provides graphical indication about the current GPS signal quality. Basically, the lower the PDOP value (position dilution of precision), the more accurate calculations are for determining position. Values below 3.0 are fairly accurate. The Pdp values can be seen in info page (select settings icon without pressing ENTER)

### ***Vario***



When the GPS M detects that the pilot is climbing, a black bar starts to grow on the left, from the bottom of the scale to the top, with 0.1 m/s increments. The same bar grows on the right, from the top of the scale to the bottom, if sinking is detected.

### ***Navigation wheel***



The Navigation wheel multi-information element which shows graphically the bearing, wind direction and thermal core. Additionally, if a destination was defined (waypoint) the navigation element will also indicates the direction to the waypoint centre, and waypoint edge and. This element cannot be resized but can be re-positioned.

### **Navigation Arrows**

When a route is active the direction of next optimal point is pointed by an arrow (larger arrow). The optimal point corresponds to the unique point on the waypoint cylinder which lies along the optimal route. If no route is defined the arrow will start showing the direction to the take off , after the take Off` is detected (Take off` is the point taken when the Flight Starts)



Take OFF is the point taken when the Flight Starts. Small course corrections are sometimes required and these are shown on the GPS M by a fine adjustment indicator in the form of a small arrow 4. Arrow 4 to the left means the pilot should turn slightly to the left, and inversely arrow 4 to the right indicates a small adjustment to the right is needed. When the course is perfect, i.e. less than 1°, the GPS M indicates this by showing a large arrow forward

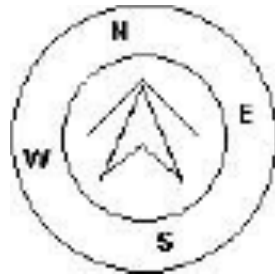

### Thermal Ball

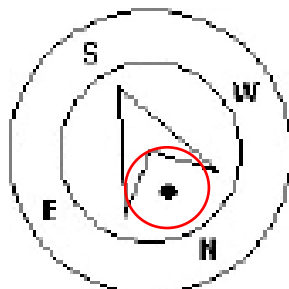

Another useful feature of the Navigation Circle Element is the thermal core ball. This map corresponds to a black dot which is shown inside the inner navigation wheel (together with the navigation arrows). During a thermal climb the GPS M keeps track of the strongest climb values point for each 50m layer. The point of strongest lift is then graphically represented by the black ball in the inner Navigation Circle, showing where the thermal core is relative to the pilot's position. The position of the dot (thermal core) is constantly updated as the pilot moves. When the pilot is over 300m from the thermal core the dot will be at the edge of the circle. As the pilot moves closer to the thermal core the dot will move towards the centre.

## Wind Flag

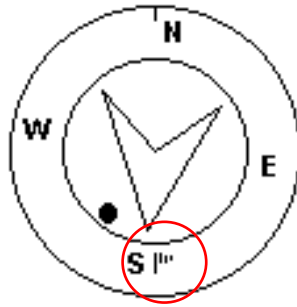

The external circle contains a small ag which indicates the Wind Direction relative to the pilot direction (direction the wind is coming from). For example, if the pilot is facing the wind then the flag is on the top of the circle. In the example of the image above , the wind is blowing from South.

## Profile Widget

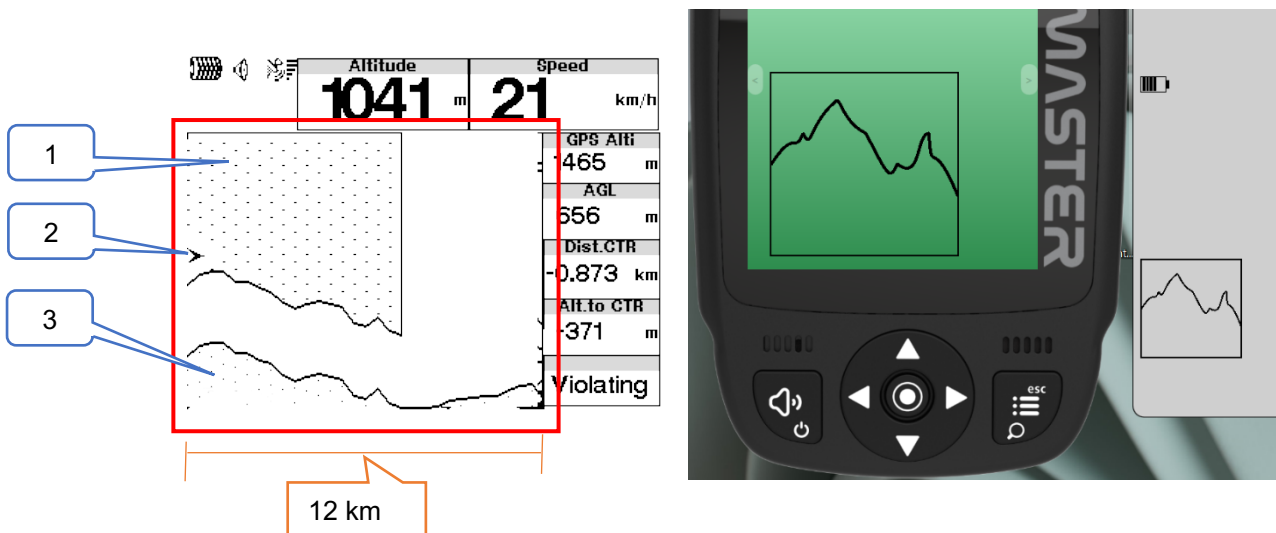

The Profile view or cut-side view projection allows you to visualize the terrain ahead, and the corresponding airspaces.

Airspaces are represented by lines showing their boundaries. They are represented in dots when there is a violation.

This view allows you to view 12 km ahead of your current position, being updated when you deviate more than a certain angle from your azimuth of travel and that justifies the update.

- 1 – Airspace limit and status
- 2 – Your position
- 3 - Terrain

## Map Layer Selection



### **Airspaces**

When the element of Airspaces is inserted in a layout using F.I.M, a 2D map (box) is shown on the instrument (see Figure above). On the bottom left of the map the scale is indicated in Km, and on the centre of the map is an arrow. This arrow represents the pilot position, and its orientation indicates the bearing of the movement. The map is always oriented North Up.

Note: When new Airspaces data element is uploaded to the GPS M using F.I.M the previews data is deleted. If a empty Airspaces data element is uploaded then all the Airspaces will be deleted.

The first time the map is drawn, it is centred on the last GPS position the GPS M has in its memory. The map is re-centred once the flight starts i.e. when a valid gps signal exists, and the start speed is reached.

Once the flight starts, the map is redrawn with an arrow (representing the pilot) which will move around the map, indicating the relative position of the pilot to each of the airspace areas. If the pilot is outside a visible airspace area then a gray line is used to draw the area, whereas if the pilot is inside the airspace then a black line is used instead. Note that being inside a airspace area (2D) does not mean that the airspace is being violated, since the pilot can be above, or below the defined 3D shape. In order to have more information about possible Airspace violation, some data fields should be added to the layout. This data fields are Distance to CTR, Altitude to CTR, and CTR Status.

The Dist. CTR data field shows the shortest horizontal distance to the nearest airspace line. This distance is always positive. Similarly, the Alt. To CTR shows the shortest vertical distance to nearest airspace line. Unlike the horizontal distance, the vertical distance can be negative. A positive vertical distance indicates that you are outside the airspace, whereas a negative distance indicates that you are inside the airspace. Additionally, the CTR status field will indicate if an airspace is being violated by displaying Violating. If the pilot is not violating the airspace but it is inside a predefined margin then the messages Altitude Imminent, or Position Imminent will be shown.

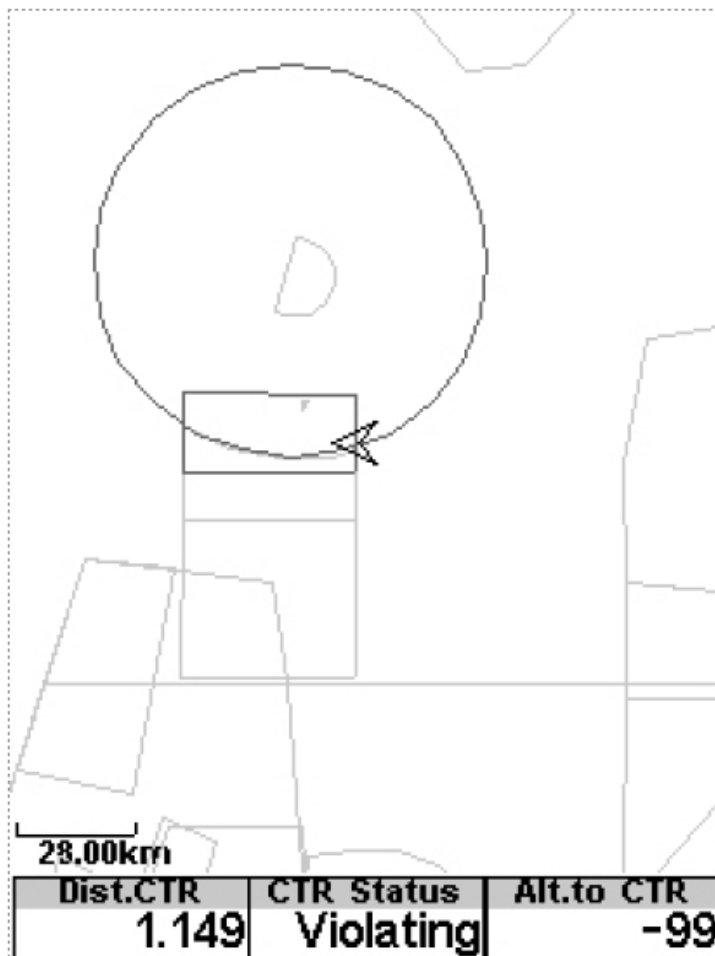

Route

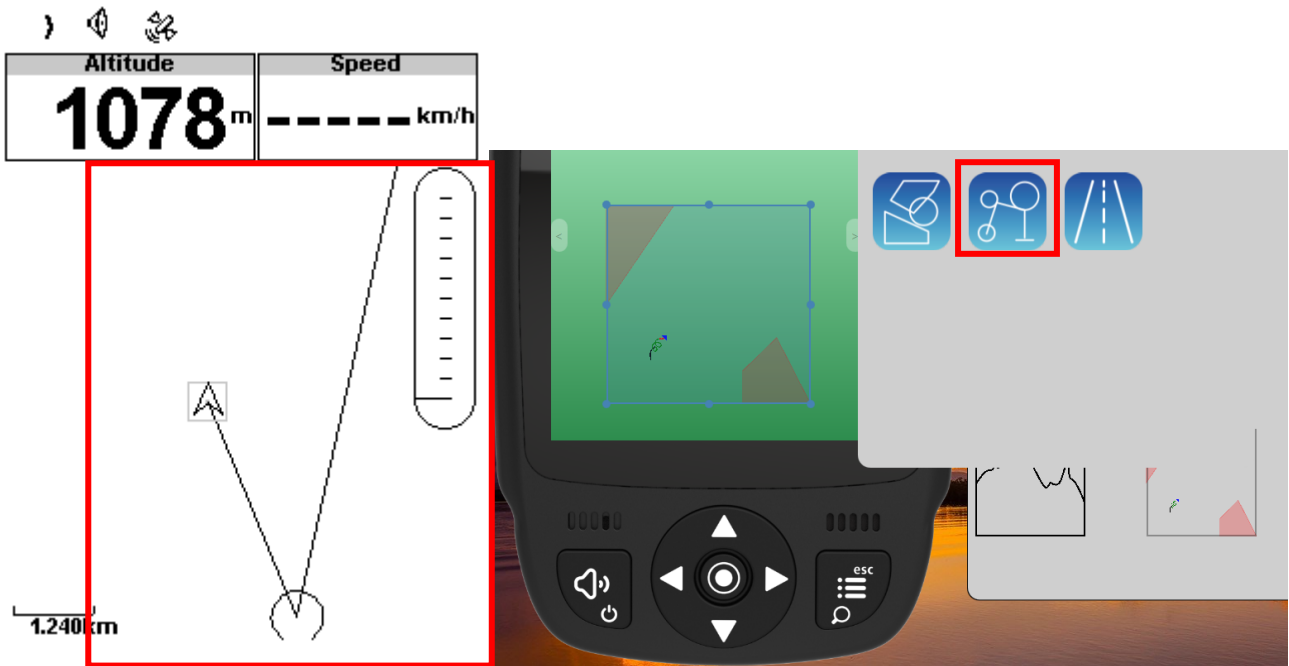

## Roads



## Wind Arrow



When used in a layout an arrow is drawn showing the wind direction relative to the pilot direction (direction the wind is coming from). For example, if the pilot is facing the wind then the arrow points south (bottom of the screen). Centered over the arrow is a circle in which a number is displayed showing the wind speed. In the example above the wind is blowing from South. Both, the wind speed, and direction, value can be seen in a data field.

## Compass



The Compass element show all the data provided by the GPS M built in magnetic compass. The compass includes an red top arrow which is always aligned with the GPS M . If the GPS M is turned the cardinal points will also turn in order the arrow tip points the right cardinal point.

In the example of Figure the GPS M is pointing NW. The direction is represented by the arrow, and also indicated numerical (318°degrees).



## Waypoints/Route

Waypoints		Route	
D01151	D L	D01151	D L
D02145	D L	T10095	GR 3.6
D03124	D L	G11062	G 34.7
G01095	G	T11083	VID 34.0
G02042	G		
G03035	G (		
G04067	G		
G05042	G		
G06062	G )		
G07060	G		
		0000	Total: 72.3

Add WP to Route
Insert New WP
Edit WP
Delete WP
Delete All Waypoints
Go to Point
Edit Route

**Add a waypoint to the Route** - select the waypoint that is to be added by pressing either the UP or DOWN buttons until the desired waypoint is highlighted. Pressing the ENTER button will add the point onto the TL on the right, at this moment the task point options for the newly added waypoint will appear in the DO area, allowing to set several aspects of the task point (these can also be edited later)

**Insert New WP** - This menu allows the user to add a new waypoint to the waypoint list. If the GPS is fix, then the co-ordinates and altitude used for the waypoint are based on the current position.

**Edit waypoint** - Entering this menu allows the properties of the selected waypoint to be changed. The name of the waypoint can be changed, along with the elevation, latitude, longitude and if the waypoint is to be designated as a landing field. To change any of the properties of the waypoint, first select the waypoint. Pressing ENTER pulls up the menu allowing the waypoint to be edited. Pressing the ENTER button again will show a cursor, indicating the character to be edited. Characters can be changed using UP and Down cursor buttons. Pressing the ENTER button will move the cursor to the next character.



**Delete Waypoint** - It is possible to delete just a single waypoint on the GPS M. Select the waypoint to be deleted by pressing either the UP or DOWN cursor buttons. Once the waypoint is highlighted, selecting Delete Waypoint will remove the waypoint from the GPS M memory. If a waypoint is in use in the Route the delete function will be disabled, to delete the Waypoint it must firstly be removed from the Route.

**Delete all waypoints** - All of the waypoints can be removed from the GPS M. Delete all the waypoints will also delete the Route. When selecting this option the GPS M will prompt to ensure that this is exactly what is intended.

**Go to point** - Selecting the Go To Point will force navigation to the selected waypoint. Once selected (by pressing the ENTER button), the instrument will jump to the flight screen automatically and navigate to that point. When returning to the Waypoints/Route will cancel the active Go To.

The Go To function will override the Route navigation, although the GPS M will remember where it was in the Route, so when the Go To is cancelled (as described above) it will resume the route at the point it was at before the Go To was activated.

**Edit route** - The GPS M will only store one Route. This is deliberate to prevent flying an incorrect Route. A Route can be edited by selecting the Edit Route option of the WAM. Selecting the Edit Route option will highlight the first Route point in the TL area.

**Load waypoints from file** – The GPS M can load a waypoints list directly from a waypoints file stored in the SD card. The file must be present in the root directory of the SD card in **.WPT (Geo format) ONLY**.



## Nearby landings

Nearby Landings	
57.3	FXC002
293.0	FXC003

Distance	0.803 km
Altitude	14 m

It is possible to define waypoints as Landing, allowing the pilot to quickly check for landing options. The Nearby Landings page will show all the waypoints, defined as Landings, for which the necessary glide ratio is finite. Glide ratio's are calculated once the Flight Starts. Besides the waypoint name the distance and glide ratio are also shown. The list is sorted by glide ratio in ascending order. On the example of Figure the closest airfield is 0.803 Km from our present location, and the necessary glide ratio to reach it is 57.3. The Nearby Landings page can also be used to make a Go To. Use the UP, and DOWN keys to select the desired waypoint, then push the ENTER key to immediately activate navigation to the selected waypoint. In order to define a waypoint as a landing the Landing parameter should be set to Yes in the waypoint edit screen.



## Route Navigator

### Route Navigator

FXC002

**FXC003**

FXC004

FXC005

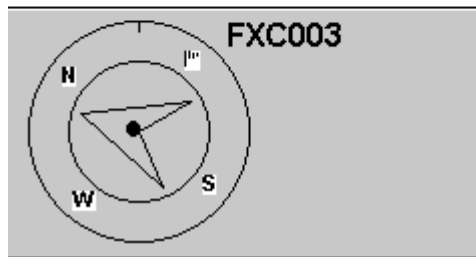

This function is useful to override the automatic route navigation provided by the GPS M , and should only be used if for some reason a mistake was made during the creation of the route.

When this option is selected the GPS M displays the route waypoints list. Using the UP and DOWN buttons the desired waypoint can be selected. Pressing the ENTER button will cause navigation to be resumed to the selected waypoint. Route navigation will then continue in the sequence displayed in the route menu.



## Nearby Airspaces

### Nearby Airspaces

LP PORTO TMALOWE  
Porto TMA 1  
Porto TMA 2  
DUMMY

Internal Airspace count: 0  
Nearby Airspaces count: 4  
SD Airspace version: 4.40

Nearby Airspaces shows a list of airspaces that are closer from the pilot's position than the distance and altitude thresholds defined in the Airspace Settings .This list is generated when in flight mode and is ordered by the sequence in which the airspace appears in the file used to create the airspace. For example, if the altitude, and distance threshold is set to 200 meters then all the airspaces that are closer from the pilot's position than 200 meters are shown on the Nearby Airspaces list. A typical list of airspace may look like figure above.

Nearby Airspaces
<b>LP PORTO TMALOWE</b>
Porto TMA 1
Porto TMA 2
DUMMY

-----	
Dist_CTR	<b>0.371</b> km
Altitude	<b>0</b> m
Floor	<b>1676</b> m
Ceiling	<b>7468</b> m
Class	GP

### ***Airspace detail***

If a airspace is selected using cursor buttons, the lower field is populated with the airspace data

The Distance to the CTR

The Altitude which is the reference altitude for the airspace

The floor of the airspace which is the lowest altitude of the airspace

The ceiling which is the maximum altitude of the airspace.

The Airspace class

Pressing enter will allow to enable/disable the airspace



## Flight Log

Flight Log	
1	Date: 2022-07-15
2	Time: 14:09:01
	Dur.:00:11:33
	Max.Alti:- 1m
	T.off Alt.:1050m
	Above Toff:- 1m
	Max.Sink:- 14.5m/s
	Max.Climb:7.7m/s
	Max.Speed:60.0km/h
	Distance:132.6km
Generate IGC Delete flight Delete all flights	

The Flight Log option allows the user to access information about previous saved flights. The top half of the screen lists details stored in memory. Each flight is identified by the take off date, time and flight duration.

After pressing ENTER in a flight log, there are 3 options available

**Generate IGC** – This will generate the IGC for the SD card. The file will be stored in the root directory of the SD card.

**Delete Flight**

**Delete all flights**



## Device settings



**Factory settings** - Reset all parameters to the default factory values. This will not change the layout to the factory default layout. Care should be taken because all changes made by the user are lost.

**Reset Now** – This will the reset the instrument to load the factory settings.

**On Landing** - If set to Yes the GPS M turns OFF if the GPS speed is less than 5 km/h, and integrated vario less than  $+1.5$  m/s, for more than 30 seconds.

**User:** Pilot name

**SN: Serial number**

**Battery:** battery percentage

**Charging mode** (quick charge, slow charge)

**Charge up time:** time remaining to full charge

**Firmware:** firmware version

**Cur:** actual current being used by the instrument

**Diag:** diagnostic code

**3.000A or other value:** battery capacity reported by the “fuel gauge” IC.



## Set Altimeter

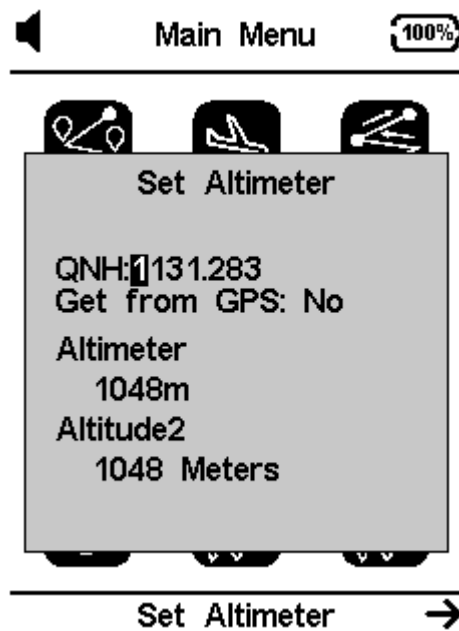

The Set Altimeter page, allows the user to adjust the barometric altimeter. A barometric altimeter calculates altitude based on atmospheric pressure, and should not be confused with the GPS altitude, which is calculated based on satellite information. Since atmospheric pressure can vary substantially with meteorological conditions, and so with time, the barometric altitude also varies accordingly. In order to have the correct altitude for a certain place the altimeter should be calibrated. Altimeter - Calibrating the altimeter can be achieved by entering the known altitude of the location. Entering an altitude automatically calculates the QNH, which is the local barometric pressure adjusted to sea level.

**QNH** - Alternatively, the altimeter can be calibrated by adjusting the QNH for the local, and time. Changing the QNH will adjust the barometric altitude. Altitude can also be set from the GPS.

**Get from GPS** - Get from GPS field which can be set to Yes No or Auto. Adjusting this value to Yes will make the GPS M take the altitude from the GPS and adjust the altitude accordingly. The Yes is not stored in the setting, since it is a one time only operation. The Get from GPS can also be set to Auto, with this value being stored in the settings. When Auto is selected, after being turned On, the GPS M will automatically set the altimeter to the GPS altitude (once a valid GPS signal exists), or whenever the pdop value is lower than the previous one. Note that position dilution of precision (pdop) gives you an indication of how reliable the GPS altitude is at the moment. The lower the pdop value the more accurate the position fix



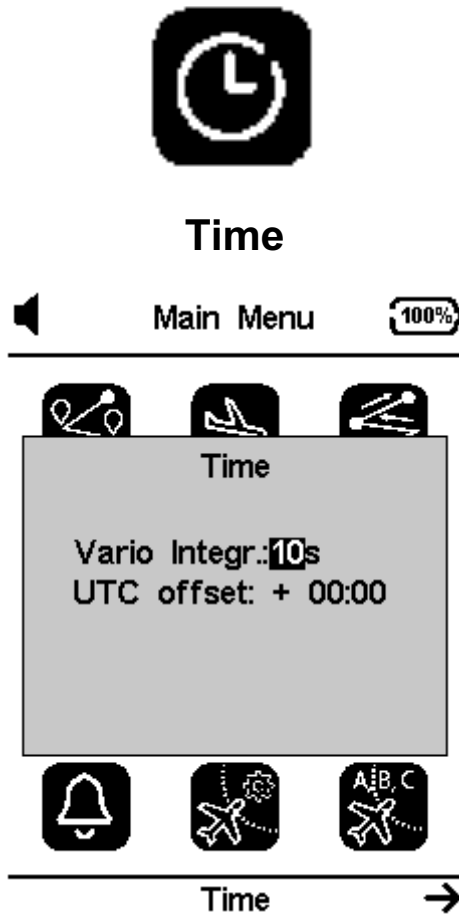

**Vario integrator** - The Integrated vario is calculated by integrating the vertical speed during a period of X seconds defined by this value. In the example, the integration period is 10 seconds (default value).

**UTC offset** - Using GPS data, the GPS M automatically adjusts the internal clock to the Universal Coordinated Time (UTC)



## Alerts

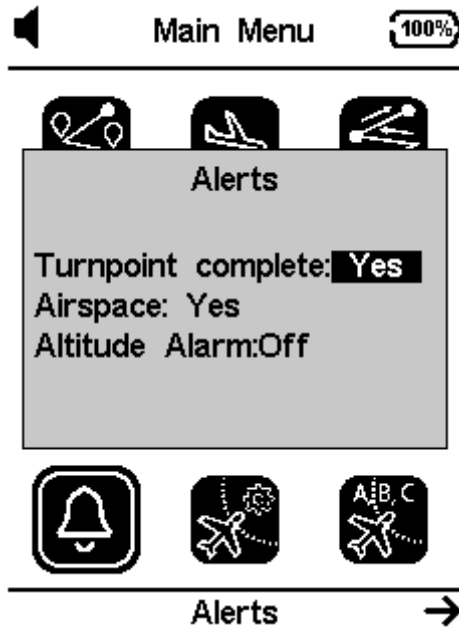

**Turnpoint complete-** A alarm (brrrr sound) and/or voice warning is made indicating approaching or that the pilot has crossed a turnpoint.

**Airspace alarm** - A siren type sound is produced and voice warnings indicating that the pilot has entered the buffer zone close to airspace.

**Altitude alarm** - A siren type sound is produced and/or voice warnings indicating that the pilot is approaching or has entered the altitude limit, described bellow.



## Airspace settings

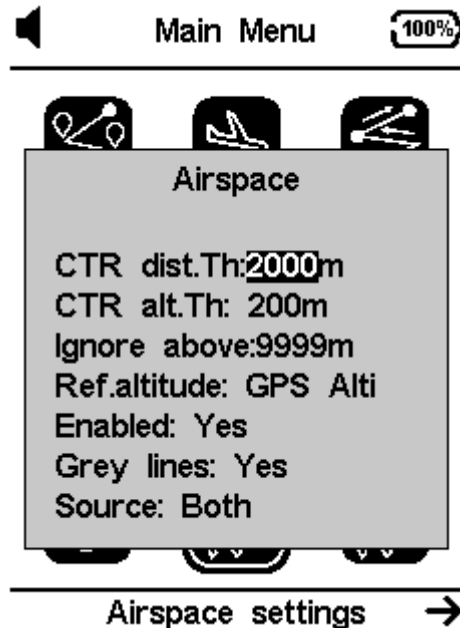

**CTR Distance Threshold:** This value is defined for which the horizontal distance passes to issued warnings of imminent proximity to the airspace. This value acts as a safety margin to avoid late warnings.

**CTR alt. Threshold:** This value is defined for which the vertical distance passes to issued warnings of imminent proximity to the airspace. This value acts as a safety margin to avoid late warnings.

**Ignore above:** You can set an altitude at which to ignore any airspace.

**Ref. altitude:** Here you can define the type of altitude reference for airspace warnings. It can be set by barometric altitude, GPS altitude or FL (flight level)

**Enabled:** You can enable or disable ALL airspace warnings (this setting is critical and must be set with maximum careful)

**Grey lines:** In the airspace map object the airspace limit lines can be represented in gray or black.

**Source:** this is define where the airspaces will be read from. It's possible to read from the SD card (world.frd) , internal memory (OpenAir files loaded by Flymaster Instrument manager) or both sources.



## Airspace classes

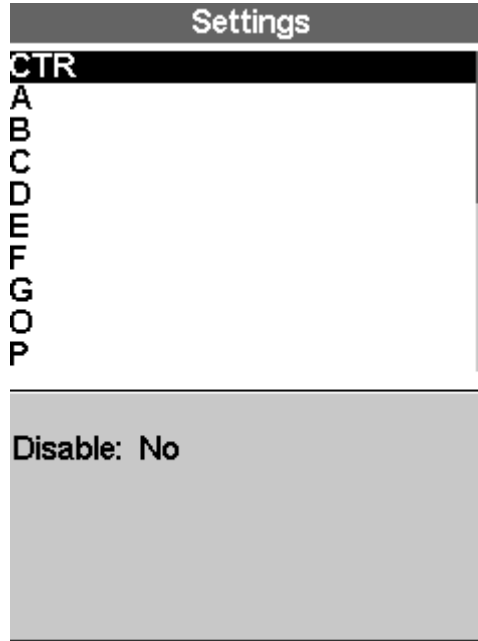

Here you can selectively define which type of airspace class you want to disable. This setting is especially useful for disabling airspace warnings that are allowed to free-flying aircraft and which are listed in the airspace files.



## Trace

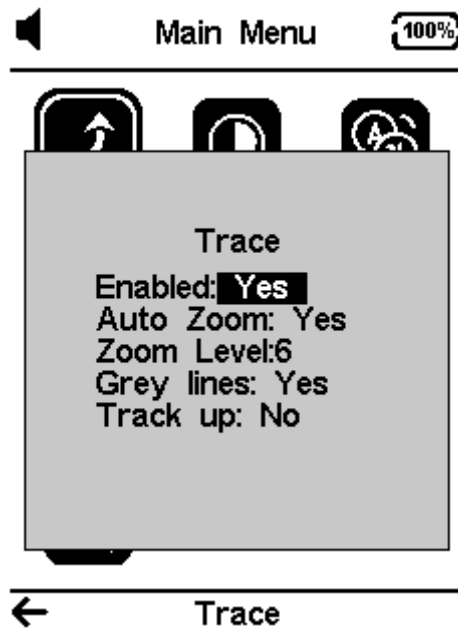

This option sets the behaviour of the traces drawn on the Map view

**Enabled:** Setting this option to Yes will draw traces on the Task Map, setting No a trace will not be drawn.

**Auto Zoom:** Setting Yes causes the system to automatically zoom into the trace when entering a thermal, making it easy to understand the location of the thermal.

**Zoom level:** this will define the amount of zoom trace when entering a thermal, making it easy to understand the location of the thermal.

**Grey lines:** Set Yes the trace lines in lift will be drawn in black while the sink will be drawn in grey. Set to No and all the trace lines will be drawn in black.

**Track up:** allows the trace to be displayed with either the track relative to North or with the current heading to the top of the screen. When Track UP is YES you will see the map turning around the pilot, while with North UP you will see the pilot moving around the Map.



## Screen

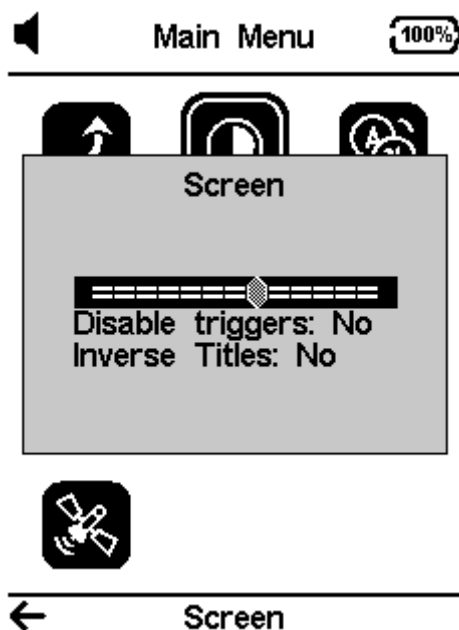

The screen menu option allows the user to set the Screen contrast to Enable/Disable the pages triggers, and to colour-invert the titles.

**Contrast** may be adjusted to the pilot's needs. You can use the LEFT, and RIGHT cursor keys, to move the contrast bar.

When in the desired position push the ENTER key to confirm the value.

**Disable triggers:** This will allow to enable/disable auto page switching (triggers). The page triggers can be set using Flymaster Instrument manager.

Page event triggers are a important unique feature of the GPS M . Pages can be automatically activated (switch to) during flight by associating one of the pre defined trigger events with the page. Triggers are set using the Flymaster Instrument Manager .Each trigger is activated when certain conditions are met. If a trigger is activated the GPS M switches to the associated page automatically. For example, consider that page 3 is associated with the trigger Airspace Warning, and the current displayed page is page 2. If during flight an airspace limit is reached the device will automatic change the page 3.

**Inverse titles:** This will allow to invert colour in the data fields titles.



## Language units



The Language/ Units menu option allows the user to change the GPS M interface language and units.

The UP, and DOWN keys, can be used to change each field option. Pushing the ENTER key confirms the current field value, and highlights the following field. Pushing, the ESC key will undo changes.

**Language:** Defines the interface language.

**Altitude units:** Altitude Units. Altitude can be show in Meters, or Feet.

**Rate of Climb Units.** ROC can be show in m/s, or 10 x Feet/ min

**Speed Units** can be in Km/h, Miles/h, or Knots.

**Distance units** can be in Km, or Miles.

**Internal Temperature:** units can be Celsius or Farenheit.

**Coordinates:** DD°MM'SS; DD°MM.mmm' ; DD.dddd; or UTM



## FLARM

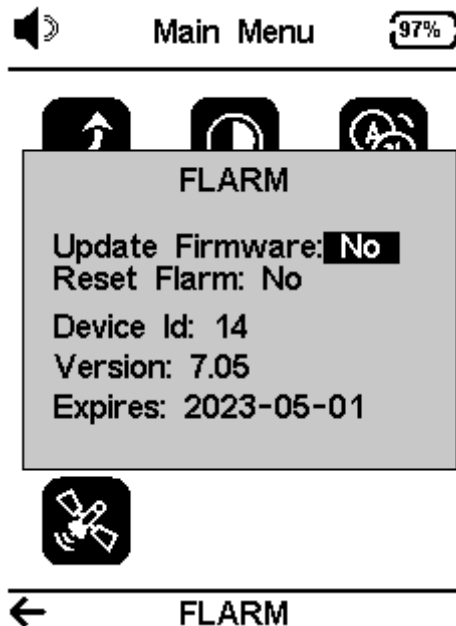

The GPS M can optionally include the FLARM module. This only works as "beacon" mode, that is to say that your position can be seen by other aircraft equipped with bi-directional FLARM (for example a LIVE DS with the optional "FLARM AWARE"), but the GPS M will not be able to see or alert of the presence of other aircraft.

Even so, the FLARM beacon is currently the most popular and most implemented mean of being seen in the skies and has the potential for an aircraft to deviate from its current position, thus avoiding a potential collision with you.





## Calibrate Compass



Use the cursor buttons to navigate the Menu. Press ENTER to choose Calibrate Compass from the main menu. Press ENTER to calibrate. Rotate the instrument slowly in all possible axes freely. A 20 second countdown will be visible as the calibration status. During and after the process, the result of the calibration quality is shown, which varies from low, medium or high. The process ends with the message “calibration ended”. Repeat as many times as necessary until you possibly get a better result, which will be HIGH.



<https://youtu.be/P-4BvvM3xW0>





## Pages

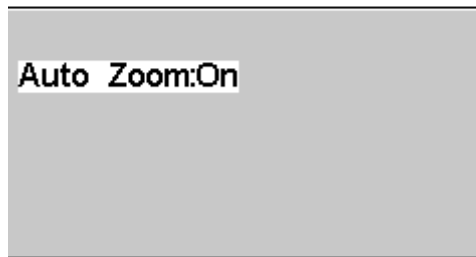
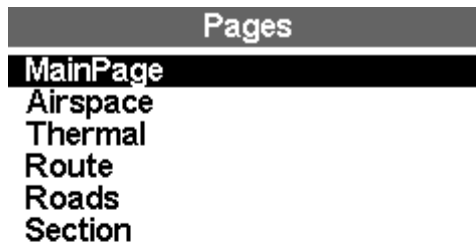

The Pages Menu shows a list of the current Layout pages that are available on the GPS M . Furthermore, the pages Menu can be used to switch page, or to Disable/Enable each of the available pages. A Layout can include 8 different pages in portrait and 8 in landscape, and all of them can be drawn using the Flymaster Instrument Manager software.

You can select different pages by selecting either the UP or DOWN keys. If you press ENTER for a certain page, 2 options become available.



Pressing in a page, and selecting the **Goto Page** option and pressing the ENTER button will jump to that page on the Flight Screen. This allows the user to display any of the pages without having to resort to trigger functions to display that particular page or having to scroll through all of the pages in sequence using the a function key. It is also possible to disable a page so that when you toggle through the different pages, that page is not displayed. Also all triggers associated with the disabled page will be ignored.

### **Disable Page**

Once a page is disabled, an asterisk will be shown on the pages list prior to the page name as shown in Figure bellow (in this case P1 R2G after start is disabled).



Note that on Figure above when selecting and pushing ENTER the Goto Page option is not active and the focus will be on the Enable Page. Pressing ENTER will re-enable the page.



## Navigation settings

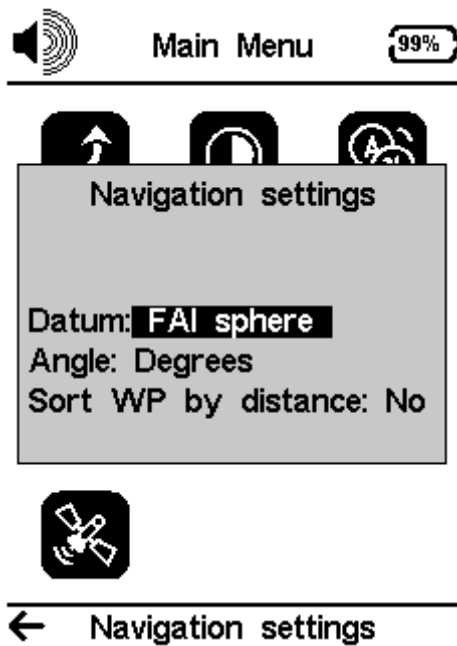

**Datum** - Two datum models can be set on the GPS M . Options available are WGS 84 and FAI sphere. At the start of any flight, be sure to check what Datum is used by the scoring system to ensure that the correct distances are being reported.

**Angle** – Angle units to be used during navigation.

**Sort WP by Distance:** If set to Yes, the waypoints list will be sorted by distance, being the closest ones listed first. If set to NO, the list will be sorted by alphabetic order.



## Vario acoustics



The Vario Acoustics settings menu option allows the user to change vario sound related parameters. The user can change the climbing, and sinking rate sound through the respective threshold values. These thresholds correspond to the climbing and sinking rates at which the sound activates. The user can also define in the the Acoustic Thresholds option the sink alarm and the sound volume of is the GPS M.

**Sink Threshold** - The Sink Threshold is the rate of descent at which the vario will emit a low frequency sound. Contrary to the climb sound the sink sound is continuous. The deeper the sink rate the lower the sound frequency. Default value for this parameter is -2 m/s, we suggest setting a value lower than the natural sink rate of the glider when flying with speed bar in still air.

**Climb Threshold** - The Climb Threshold defines the rate of climb at which the vario will start beeping. The frequency of the first beep is defined trough the Base Frequency parameter, and steadily increases according the Increments parameter value. The default value for Climb Threshold is 0.1m/s. This means that beeping starts once the instantaneous vario value goes above 0.1m/s.

**Sink Alarm** - The Sink Alarm defines a vertical speed value at which a sound (alarm siren) starts to be produced. For example, if the Sink Alarm is set to -10m/s, then if the instantaneous vario goes below -10m/s, and alarm will be "red. This alarm can be used to identify high vertical speeds, as for example, in a spiral dive. The Sink Alarm parameter can vary from 0 to -25m/s. Set the Sink Alarm to OFF to disable the alarm.

**Base Frequency-** The audio frequencies can be adjusted to match the user's preference, by setting the Base Frq and Increments.

The Base Frq is the first frequency used to produce the initial sound which corresponds to the climb threshold (by default 0.1 m/s). Later, as the climb rate increases, a bip, bip sound is produced for which the cadence, and frequency, also increase. The Base Frq can be set from 500 to 1500 Hz. The higher is the frequency value, the higher pitched the sound is.

In order to change the base frequency value press the ENTER key after the Audio Frequencies menu option is highlighted. This action will highlight the Base Frq value so it can be increased using the UP key, or decreased using the DOWN key. The ENTER key should then be pressed, thus confirming the Base Frq setting. The pre-set value for Base Frq is 700 Hz.

**Increments-** The Increments parameter sets the frequency increment for each 0.1 m/s climb rate increase. The increments can be set from 1 to 99 Hz. The pre-set value for Increments is 10 Hz.

Considering an Increments value of 10, and Base Frq of 700 Hz, the vario frequency at 1 m/s is 800 Hz.

**Cadence -** When a rate of climb is higher than that specified by the Climb threshold the GPS M creates a beeping sound. The rate (cadence) of the beeps increases as the climb rate increases. This increase in rate is not linear. The cadence parameter specifies which cadence curve should be used. Current there are 2 possibilities represented in the graph of Figure below.

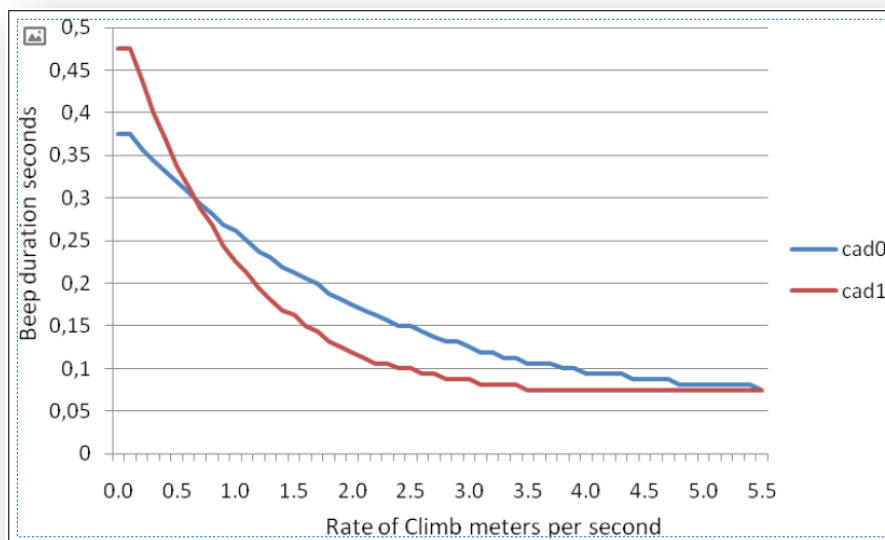

**Buzzer -** Is so called because of the sound it emits, which resembles a buzzing sound.

The buzzer sound is produced when the rate of climb is close to, but has not yet reached the specified Climb threshold. This value is set between 0 and 9 with each unit corresponding to be 0.1 m/s, ie. 3 is 0.3m/s. Subtracting this decimal value from the climb threshold will give us the value

at which the GPS M will start buzzing. For example with the GPS M default values, Climb threshold=0.1m/s, and Buzzer=3 (0.3m/s) the buzzing will start at -0.2m/s because  $0.1 - 0.3 = -0.2$ . In this case at 0.1m/s directly below the Climb threshold the GPS M will emit a constant sound varying rapidly in pitch from around 100hz to the set base frequency at which the first beep is emitted. This is the buzzer sound and may resemble a growl noise.

Setting the Buzzer value to 0 will disable the buzzer feature.

Although the Buzzer will sound very annoying on the ground it becomes an amazing companion in flight allowing the pilot to pick-up thermals he would have usually missed

A practical example of the advantages of the buzzer feature can be illustrated in Figure below. In this example both pilots are sinking at -1.0 m/s. The orange paraglider has a GPS M for which the climbing threshold is set to 0.1 m/s and the Buzzer parameter is set to 3 (0.3 m/s). The green paraglider has a typical vario for which the climbing threshold is set to 0.1 m/s.

As shown in the figure, when both pilots enter the thermal nothing is heard. The air is rising at 0.1 m/s but both pilots are descending at -0.9 m/s. In the second zone of the thermal the air is rising at 0.8 m/s, and so pilots are descending at -0.2 m/s. At this stage the orange pilot starts to hear the Buzzer brrrr sound of his GPS M, which helps him to centre the thermal, while the green pilot is still unaware of the thermal. Finally, in the 3 zone, the air is rising at 1.2 m/s, and so both pilots climb at 0.2 m/s. The GPS M pilot starts to hear his vario beep... beep... sound, and it is only at this point the green pilot hears the first beep from his instrument.

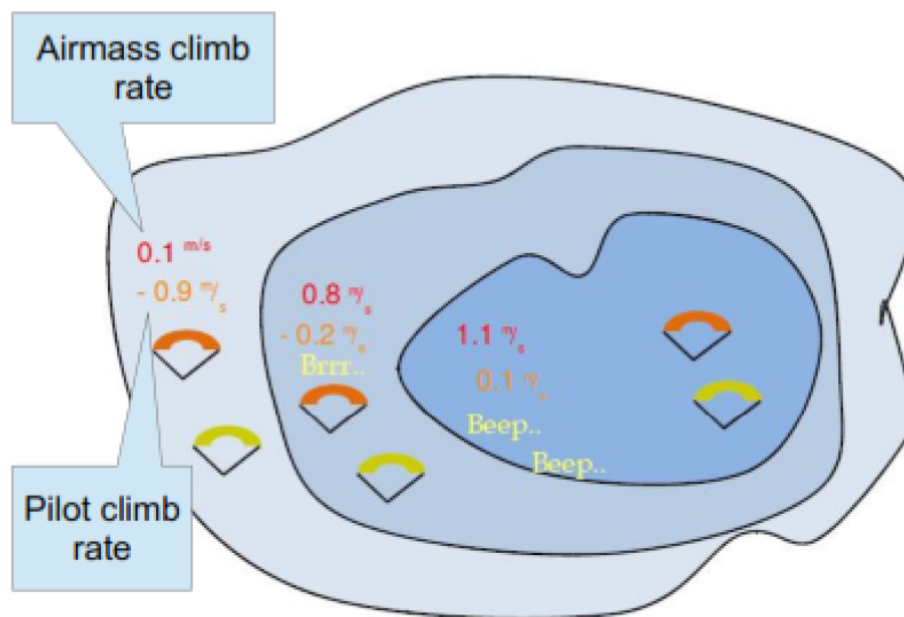

**Damper** - The GPS M's vertical speed calculation is based on air pressure variations. It is very seldom to have air pressure absolutely stable. Turbulence caused by air moving near the sensor is sufficient to cause small variations in pressure. For this reason the GPS M filters (averages) the pressure data to prevent constantly detecting tiny pressure variations. The value that defines how much the pressure is filtered is the Damper. Setting a lower damper value causes the GPS M to become more responsive but harsher. Inversely a higher value causes the GPS M to be less responsive but smoother. The default value is 6.

**Dynamic Frequency**- The GPS M beeps at a specified pitch (frequency) when a certain rate of climb is encountered. When dynamic frequency is zero, the pitch (frequency) of that beep will remain constant if the rate of climb changes. With dynamic frequency on, the pitch of the beep may vary if the rate of climb varies during the individual beep.



## Advanced Settings



**Auto Silent-** Setting Auto silent option ON will keep the GPS M 's vario quiet until a Start Flight has been detected. This function avoids listening the vario sound while waiting to take off. The audio will then be kept active until the GPS M is switched off. The default value for the auto silent parameter is ON.

**Start Speed -** The start speed is one of the Start Flight conditions, and it is used to define the minimum GPS speed, in Km/h, that should be reached in order to initiate the flight. Note that the Start Flight event is important to many other functionalities, so care should be taken when setting this value. For example, if Auto Silent is on, the vario will only beep after the flight starts. The track data is also only saved after the flight starts. If set to 0 "zero" the flight will start immediately after GPS fix position is acquired. This setting is only recommended in very exceptional occasions like walk-and-fly activities, because will produce a track log each time the instrument is turned on.





## GPS

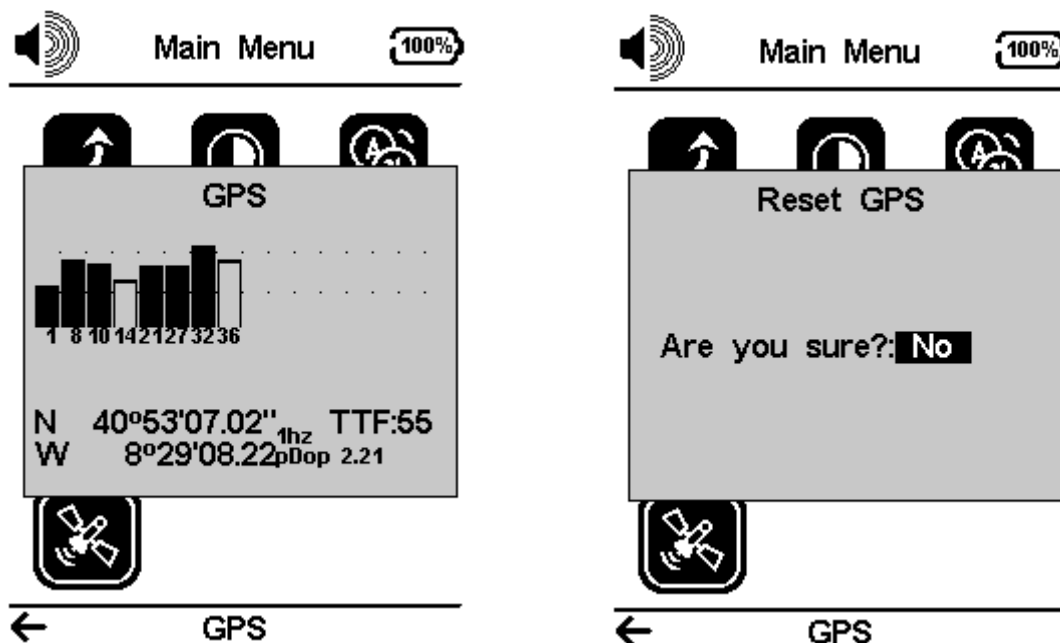

**GPS satellite status page:** In this example above the GPS M shows that 8 satellites are visible, and 6 are being used to provide the position fix. Each bar shows the signal strength for each individual satellite. A filled bar indicates the GPS M has a lock on that satellite. The position dilution of precision (pdop) shown gives an indication of how reliable the GPS data is at the moment. The lower the pdop value the more accurate the position fix. Values below 2.5 are fairly accurate. If the GPS M is switched on in a location where no satellites are visible (indoors for example) it will go into wide search mode. If this occurs, going outdoors again will make the GPS M take an increased amount of time to pick up satellite signals. If this occurs pushing ENTER on the GPS menu item will reveal the Reset GPS option, changing it to yes will make the GPS M reset the GPS status and start a new search. So if you notice GPS M is taking abnormally long to get a fix (over 2 minutes) a gps reset will probably get it locked quicker.

## Flymaster Instrument Manager Software

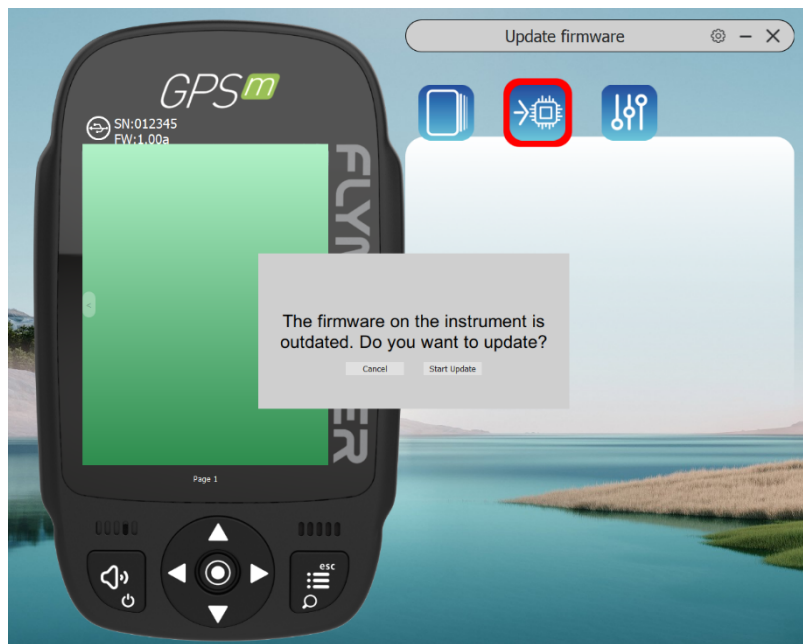

**Automatic firmware update** - After launching the "Flymaster Instrument Manager" application and if your instrument is connected to your computer's USB port, it may be possible that there is a new firmware version available for your instrument. If you want to update, just answer "start update" and the process will be automatic. Your instrument will restart, and a progress bar will appear.

## Main Screen and tools



- 1 – Previous Page
- 2 – Connection state and info
- 3- Page name (click to edit. [Can be visible in a data field](#))
- 3 – Connection state and info
- 4 – Next Page
- 5 - Pages Layouts
- 6 - Update firmware tool
- 7 – Current tool
- 8 – Settings tool
- 9 – FIM settings

## Pages Layouts data fields and objects



- 1 – New pages layout
- 2 – Open pages layout
- 3 – Save pages layout as a file
- 4 – Send pages layout to instrument
- 5 - Delete layout page
- 6 - Page Triggers (auto page switching behaviour)
- 7 – Rotate layout
- 8 – Current selected tool
- 9 - Wind arrow object
- 10 – GSM status object
- 11 – Cut Side view object
- 12 – Vario object
- 13- Map object (configurable layers)
- 14 – Altitude graph
- 15 – Volume indicator object
- 16 – Compass
- 17 – Navigation wheel
- 18 – Battery status object
- 19 – Data field

**Customizing datafields and objects**



After dragging a data field or double click it will show the customization pop-up window of it.

- It's possible to change :
- The datafield (data you want to see)
    - The title font size
    - The title background
      - The border
      - The datafield font
  - The data field background

## Page Triggers

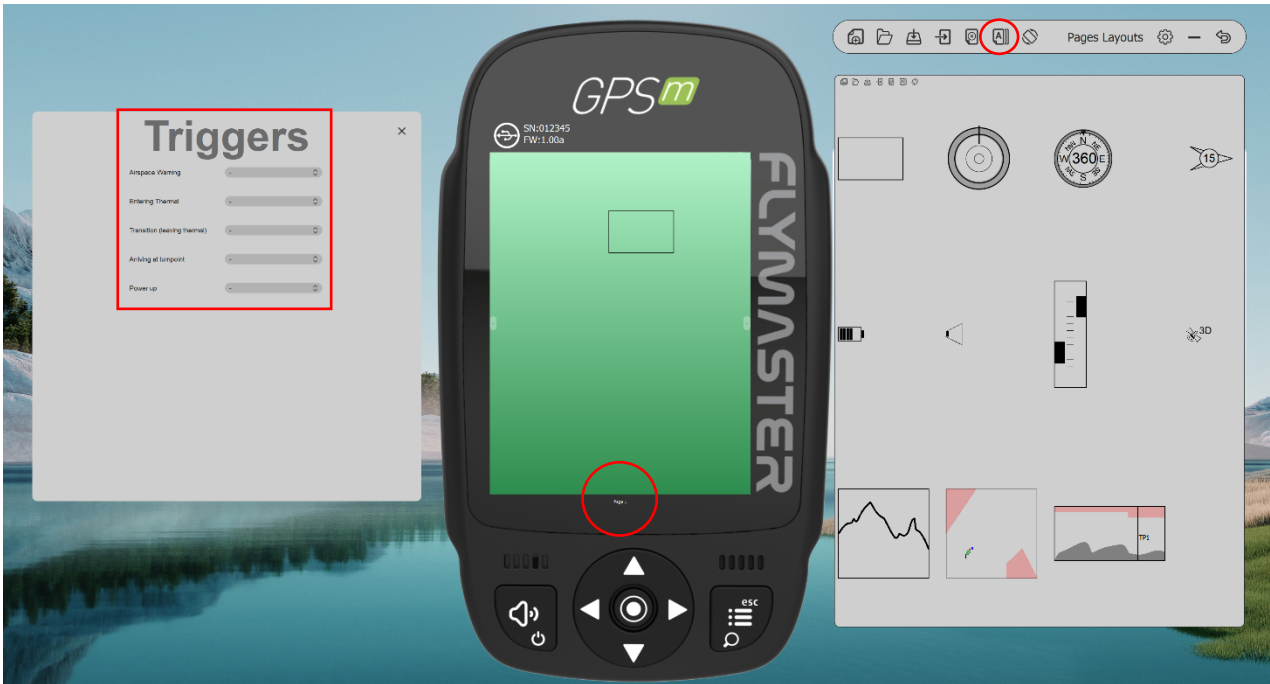

After you design or open a page layout you can configure the page trigger for each page. The page trigger it's a auto page switching when the instrument "understands" the pilot position of behaviour. When that behaviour is achieved the page is automatically called.

- 1 – Create or open a Layout
- 2 – Click on "triggers" tool

## Manual firmware update

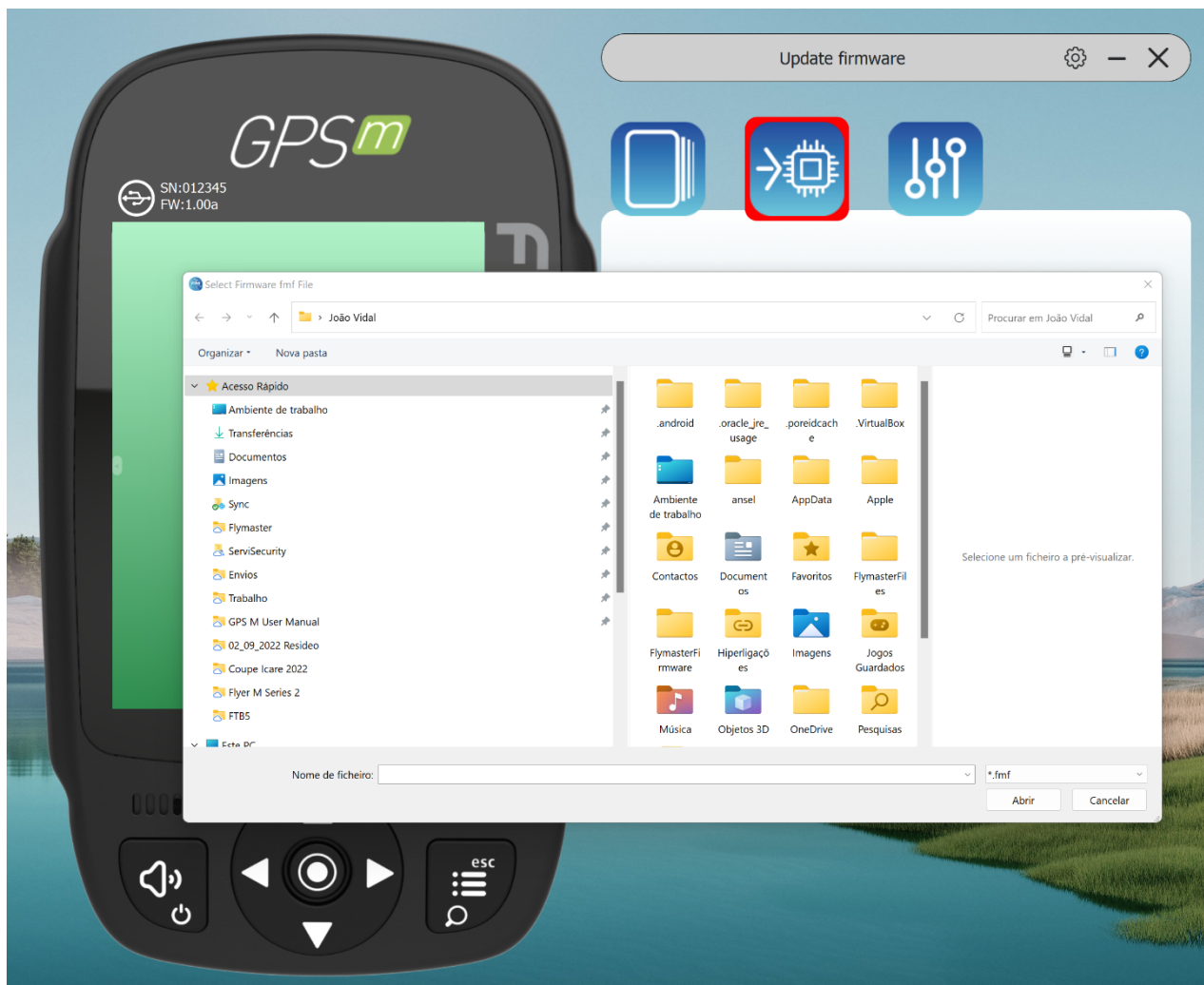

In this tool you can force manual firmware update. Just download the firmware package file, from the Flymaster website and save it to your hard drive. Then just point your location and the process will proceed normally.