

# FLYMASTER LIVE DS



User Manual  
v.1.0

# IMPORTANT

All rights reserved.

Except as expressly provided herein, no part of this manual may be reproduced, copied, transmitted, disseminated, downloaded or stored in any storage medium, for any purpose without the express prior written consent of Flymaster Avionics Lda. herein Flymaster Avionics. Flymaster Avionics hereby grants permission to download a copy of this manual onto a hard drive or other electronic storage medium to be viewed and to print a copy of this manual or of any revision hereto, provided that such electronic or printed copy of this manual must contain the complete text of this copyright notice and provided further that any unauthorised commercial distribution of this manual or any revision hereto is strictly prohibited. Information in this document is subject to change without notice. Flymaster Avionics reserves the right to change or improve its products and to make changes in the content without obligation to notify any person or organisation of such changes or improvements. Visit the Flymaster Avionics website ([www.flymaster-avionics.com](http://www.flymaster-avionics.com)) for current updates and supplemental information concerning the use and operation of this and other Flymaster Avionics products. Warning It is the sole responsibility of the pilot to operate the aircraft in a safe manner, maintain full surveillance of all wing conditions at all times, and not become distracted by the Flymaster LIVE DS . Flymaster Avionics is not responsible for any damages resulting from incorrect or no data provided by the Flymaster LIVE DS . Flight safety is the sole responsibility of the pilot. It is unsafe to operate the Flymaster LIVE DS while in the air. Failure by the pilot equipped with a Flymaster LIVE DS to pay full attention to the aircraft and conditions while wing could result in accident with property damage and/or personal injury.

## Índice

<b>Tech Specs</b> .....	<b>8</b>
<b>Overview</b> .....	<b>9</b>
<b>FLARM ANTENNA</b> .....	<b>10</b>
Warning: .....	10
Installation - .....	10
Recommended take-off position .....	10
Antenna cap - .....	11
<b>First Steps</b> .....	<b>12</b>
<b>Reset and Force install firmware</b> .....	<b>14</b>
Hardware Reset.....	14
Force install firmware .....	15
<b>Charging and battery management</b> .....	<b>16</b>
Check battery status and time remaining: .....	17
How to preserve the battery lifespan .....	18
Charging is easy .....	19
Avoid extreme ambient temperatures.....	19
<b>Keys and User interface</b> .....	<b>20</b>
Main menu navigation keys .....	20
List type menu.....	20
Setting the volume .....	21
Zoom and pan map object .....	21
<b>Default Pages</b> .....	<b>22</b>
Page 1 .....	22
Page 2 .....	23
Page 3 .....	24
Page 4 .....	25
Page 5 .....	26
Page 6 .....	27
<b>Available data fields</b> .....	<b>27</b>
A.OverGoal .....	28
Above Toff .....	28
Abs.Pressure .....	28
Active waypoint.....	28
AGL .....	28
Alt.Gain.....	28
Alt.Gain/Loss .....	28
Alt.to CTR.....	28

Altitude.....	28
Altitude2.....	28
Arrival Goal.....	28
Arrival Next.....	28
Ave.Speed.....	28
Ave.Vario.....	28
Ave.ROT.....	28
Battery.....	28
Bearing.....	28
Ceiling.....	28
Compass.....	28
CTR Name.....	28
CTR Status.....	28
Cur.G.R.....	28
Date.....	28
Dist.CTR.....	28
Dist.Edge.....	28
Dist.Goal.....	28
Dist.Line.....	28
Dist.Next.....	29
Dist.Start.....	29
Dist.Thermal.....	29
Dist.Toff.....	29
Dur.....	29
Flight Level.....	29
Floor.....	29
G-Force.....	29
G.R.Goal.....	29
G.R.M.G.....	29
G.R.Next.....	29
G.R.Toff.....	29
Goal Close.....	29
GPS Alti.....	29
Ground.....	29
Heading.....	29
Land In.....	29
Last Send.....	29
Latitude.....	29
Longitude.....	29
LPF.....	29
Max. Altitude.....	29
Max. Climb.....	29
Max. Sink.....	29
Max.G.....	29
Max.Speed.....	29
Min. Altitude.....	29
Odometer.....	30
Page Num.....	30
Page.....	30
Speed.....	30
Speed Strt.....	30
Thermal top.....	30
Thrml.Perfo.....	30
Time.....	30
Trans.G.R.....	30
Triangle Size.....	30
TTD.....	30
TTG.....	30
Turnpoint size.....	30

Vario .....	30
VMG.....	30
Wind Dir.....	30
Wind Speed .....	30
<b>Objects (Graphical Elements).....</b>	<b>31</b>
<b>Battery.....</b>	<b>31</b>
<b>Volume indicator .....</b>	<b>31</b>
<b>Communication Status.....</b>	<b>31</b>
<b>GPS .....</b>	<b>32</b>
<b>Vario .....</b>	<b>32</b>
<b>Navigation wheel.....</b>	<b>32</b>
Navigation Arrows .....	33
Route Optimisation .....	33
Thermal Ball.....	33
Wind Flag.....	34
<b>Multilayer Maps .....</b>	<b>35</b>
Airspace .....	35
<b>Wind Arrow.....</b>	<b>36</b>
<b>Compass.....</b>	<b>36</b>
<b>Flarm Aware Radar .....</b>	<b>37</b>
<b>Waypoints .....</b>	<b>38</b>
<b>Task.....</b>	<b>42</b>
<b>Task Navigator.....</b>	<b>46</b>
<b>Airspace Browser .....</b>	<b>47</b>
<b>Nearby Landings .....</b>	<b>48</b>
<b>Navigate to a Nearby landing .....</b>	<b>49</b>
Navigate –.....	49
<b>Flight Log .....</b>	<b>50</b>
<b>View Flight Details .....</b>	<b>50</b>
<b>Delete Flight.....</b>	<b>51</b>
<b>Generate Flight IGC.....</b>	<b>51</b>
<b>Report Back .....</b>	<b>52</b>
<b>Settings.....</b>	<b>53</b>
<b>Serial number .....</b>	<b>53</b>
<b>Battery percentage .....</b>	<b>53</b>
<b>Charging status.....</b>	<b>53</b>
<b>Estimated time to full charge .....</b>	<b>53</b>
<b>Estimated time of usage remaining .....</b>	<b>53</b>
<b>Charging current.....</b>	<b>53</b>
<b>Gps Status .....</b>	<b>53</b>

<b>Pdop value</b> - .....	<b>53</b>
TTF (time for first fix) .....	53
<b>Set Altimeter</b> .....	<b>54</b>
Altimeter - .....	54
QNH - .....	54
Get from GPS - .....	54
<b>Time</b> .....	<b>54</b>
Vario integrator - .....	55
Track interval - .....	55
UTC offset - .....	55
<b>Vario acoustics</b> .....	<b>55</b>
Sink Threshold - .....	55
Climb Threshold - .....	55
Sink Alarm - .....	55
Base Frequency- .....	56
Increments- .....	56
Cadence - .....	56
Buzzer - .....	56
Damper - .....	58
Dynamic Frequency- .....	58
Auto Silent- .....	58
<b>Alerts</b> .....	<b>59</b>
Goal Possible- .....	59
Turnpoint complete- .....	59
Start Open - .....	59
Off Couse - .....	59
Airspace alarm - .....	59
Altitude alarm - .....	59
Altitude Limit - .....	59
Voice gender - .....	59
<b>Thermal Trace map</b> .....	<b>60</b>
Track up - .....	60
Auto Zoom - .....	60
Thermal Zoom – .....	60
Trace Enable/Size- .....	60
<b>Language / Units</b> .....	<b>61</b>
Language - .....	61
Alti units - .....	61
R.O.C. (Rate of climb) - .....	61
Speed Units - .....	61
Dist. Units - .....	61
Temperature - .....	61
Coords. - .....	61
<b>Device settings</b> .....	<b>62</b>
Factory settings - .....	62
Reset now - .....	62
Reset GPS – .....	62
On Landing - .....	62
GSM modem – .....	62
<b>Calibration</b> .....	<b>63</b>
<b>Navigation Settings</b> .....	<b>64</b>
Turnpoint Size - .....	64
Datum - .....	64

Start Speed - .....	64
FAI comp - .....	64
<b>Airspace .....</b>	<b>65</b>
Enabled - .....	65
Dist. CTR - .....	65
Alt. to CTR - .....	65
Ref. altitude - .....	65
Ignore Above - .....	65
Draw Solid - .....	65
<b>Load Airspace .....</b>	<b>66</b>
<b><i>Flymaster Instrument Manager Software .....</i></b>	<b><i>67</i></b>
Automatic firmware update - .....	67
Main Screen and tools .....	68
Copy Airspaces File to instrument (Open Air).....	69
Copy Waypoints File to instrument (Open Air).....	70
<b><i>Pages Layouts data fields and objects.....</i></b>	<b><i>71</i></b>
Customizing datafields and objects .....	72
Page Triggers.....	73
Manual firmware update .....	74
<b><i>Maps management.....</i></b>	<b><i>75</i></b>
<b><i>Settings and instrument info .....</i></b>	<b><i>78</i></b>
IMEI .....	78
CCID .....	78
Status of the FLARM AWARE licence.....	78



## Tech Specs

Display Type.....	Dual Screen- Colour: 640x480px Grayscale: 320x240px
Battery Capacity (Lithium-Ion).....	9000mAh
Autonomy.....	Usually +24 hours (environment conditions may alter this value)
Pressure Sensor.....	High resolution barometric sensor 10 – 1200 mbar
Audio.....	Dual speaker system for separate vario and voice
Memory expansion.....	Micro SD card ( 128 Gb already included)
GPS.....	72-channel BeiDou, Galileo, GLONASS, GPS / QZSS
Microprocessor.....	Flymaster Microprocessor with proprietary RTOS
GSM.....	Multi-band LTE-M / EGPRS Module
FLARM®.....	Flarm ready with included Flarm beacon (optional Flarm Aware RX+TX mode)
Bluetooth.....	Bluetooth 5 low energy module
Native USB Type C Connection.....	Allows connection to the PC
Battery Charging.....	From wall adapter or standard usb port
Firmware update by USB (upgrades are free)	
Size.....	186x132x18 mm
Weight.....	410g



## Overview

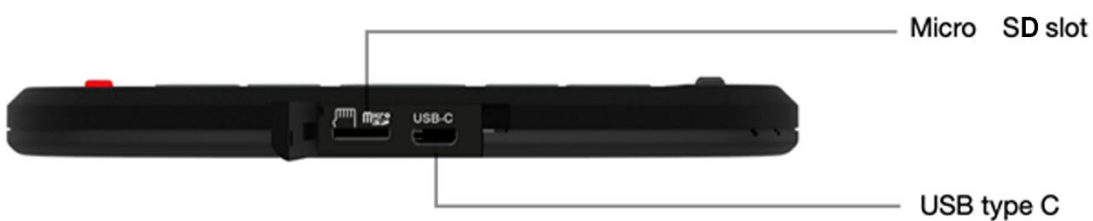

## FLARM ANTENNA

### **Warning:**

The Flymaster uses an external antenna, which has been tuned to the Flarm board circuit, especially for the band used. Although it can be considered annoying when taking off, it is an essential element for the system to work for the distances required by Flarm and which we consider to be ideal for seeing and being seen by other aircraft. The antenna included with the instrument is engraved with Flymaster branding to avoid any swapping or confusion. Any antenna other than the one sent, can lead to a malfunction of the Flarm system, leading the pilot to run the risk of being "invisible" to other aircraft and being subject to a potential accident.

**Installation** - Be sure to install the antenna, tightening it to the end of the thread securely. the tightening must be done in a clockwise direction.



**Recommended take-off position**



**Antenna cap** - When the pilot does not want or does not need to fly with the Flarm antenna, must place the rubber cap (supplied) to cover the antenna socket.

**FLYMASTER**  
**LIVE DS**  
**First Steps**

Do not delete or manipulate any files in the SD card directly. All SD card management tasks must be done through Flymaster Instrument Manager.

Not doing so, may cause the instrument to malfunction.

To copy some file from SD card to your computer, you must use your computer's file explorer using the USB connection with the instrument.

1.

We recommend the reading of the following documents:

- Warranty terms and conditions.

To do that, please use the following links:

[https://dnl.flymaster.net/Flymaster\\_Standard\\_Limited\\_Warranty\\_EN.pdf](https://dnl.flymaster.net/Flymaster_Standard_Limited_Warranty_EN.pdf)

2.

Create a Flymaster Cloud account if you don't already have one.

After the account creation go to:

<https://livetrack360.com/devices/liveds/register>

3.

Activate the Live DS

A valid Paypal account is needed to activate the LIVE DS.

Go to the following link and use the activation code

<https://livetrack360.com/vodasims/activate>

4.

Install "Flymaster Instrument Manager" to manage your LIVE DS.

Connect your instrument to the computer via USB. The instrument will appear as a mass storage.

Inside you will find a folder called "Flymaster Instrument Manager" where the installation files are located. Alternatively, you can and should download the latest version available on the Flymaster website in the "downloads" section.

5.

OPTIONAL FLARM AWARE SERVICE ACTIVATION

Flymaster LIVE DS is already equipped with FLARM BEACON and no extra service needed. This means that you will be visible to other instruments that are able to receive Flarm (RX).

If you want to have FLARM AWARE service (also receive FLARM position from others and have potential collision warnings) in your instrument you need to activate the optional FLARM aware service. To do that, go to our website ([www.flymaster.net](http://www.flymaster.net)), and under “accessories” you can buy the product “Flarm Aware”.

You must fill in the “Dev. ID” (Flarm Serial number, which can be seen on the instrument, under “Flarm” option).

After receiving a confirmation email with the activation code, you must enter it in Flymaster Instrument manager, with the instrument connected.

The cost is 50 Euros for a lifetime activation.



## Reset and Force install firmware

### Hardware Reset



If for some reason your instrument becomes unresponsive you can force a reset to recover it.

Press the power button together with pushing the scroll wheel down at the same time for 2 or 3 seconds and release.

After releasing the buttons, the instrument should switch off.

Turn the instrument back on normally.

### ***Force install firmware***



This procedure is not common to perform.  
It should only be done when there are instructions from Flymaster to do so.

To force the firmware installation (the firmware file must be located on the SD card, inside the "firmware" folder): With the instrument turned off or after performing a reset, press and hold the "FN" key, while turning on the instrument with the power key. Keep the "FN" key pressed until "installing firmware" appears on the colour display. After this phase is completed, the instrument should start normally.

[To update your instrument's firmware, just connect it to the "Flymaster Instrument Manager" and the process will be automatic.](#)

## Charging and battery management

Flymaster LIVE DS has an advanced battery power management system, which gives the pilot accurate information about the battery state, as well as the charging time and battery remaining time.

To charge the Flymaster LIVE DS battery we recommend the usage of the supplied wall charger and USB cable via USB Type-C port. Original Flymaster accessories are recommended in order to avoid damage to the power management system.

Charging, and battery status information is shown on both the power up screen and the settings info page.

When Flymaster LIVE DS is connected to a power supply (wall charger or via USB cable), the instrument will show the time remaining to full charge.

Use the supplied wall power supply to fully charge the instrument.

Note: Charging the instrument with high ambient temperatures should be avoided. Such action can cause the battery to overheat and affect the battery health.





**Check battery status and time remaining:**



Flymaster DS is charging turned off

<

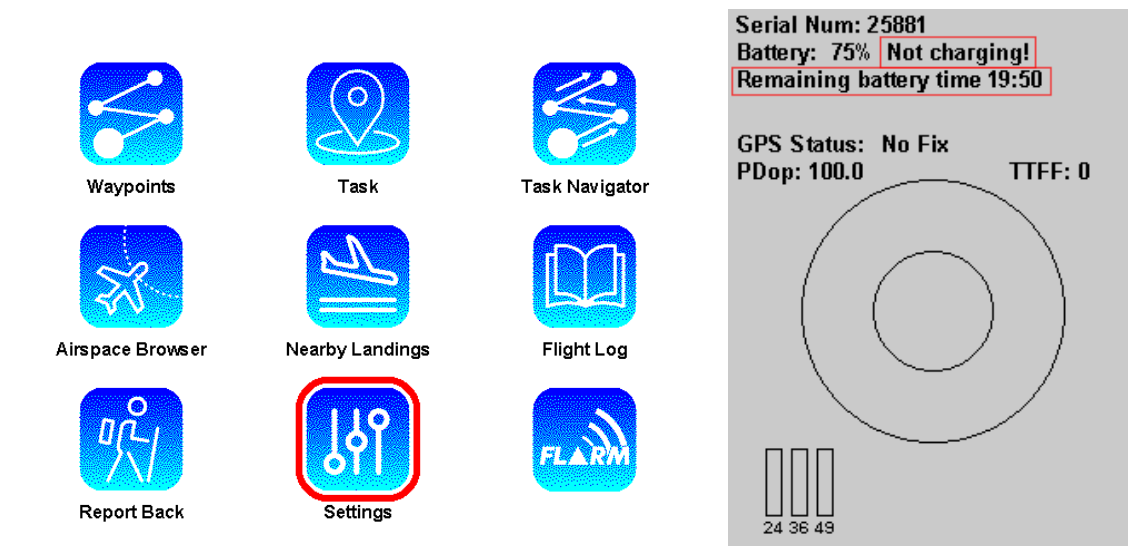

Flymaster DS is off charging. The remaining time of usage can be seen in the monochrome display.

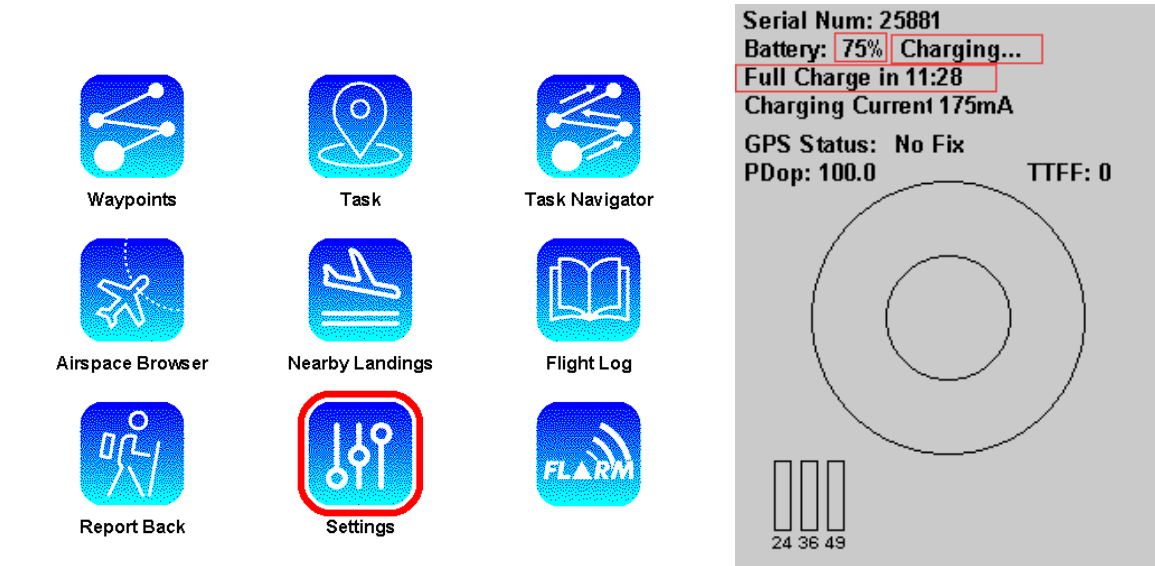

Flymaster DS is charging turned on. It's possible to check the time remaining to achieve full charge.

### ***How to preserve the battery lifespan***

All Flymaster instruments use Lithium-Ion batteries. Compared with traditional battery technology, lithium-ion batteries charge faster, last longer, and have a higher power density for more battery life in a lighter package.

The Flymaster lithium-ion battery uses fast charging to quickly reach 80% of its capacity, then switches to slower trickle charging. The amount of time it takes to reach that first 80% will vary depending on your settings and which instrument you're charging. This combined process not only lets you get out flying sooner, but it also extends the lifespan of your battery.

## **Charging is easy**

Charge your Flymaster lithium-ion battery whenever you want. There's no need to let it discharge 100% before recharging. Flymaster lithium-ion batteries work in charge cycles. You complete one charge cycle when you've used (discharged) an amount that equals 100% of your battery's capacity - but not necessarily all from one charge. For instance, you might use 75% of your battery's capacity one day, then recharge it fully overnight. If you use 25% the next day, you will have discharged a total of 100%, and the two days will add up to one charge cycle. It could take several days to complete a cycle. The capacity of any type of battery will diminish after a certain amount of recharging. With lithium-ion batteries, the capacity diminishes slightly with each complete charge cycle. Flymaster lithium-ion batteries are designed to hold at least 80% of their original capacity for a high number of charge cycles, which varies depending on the instrument.

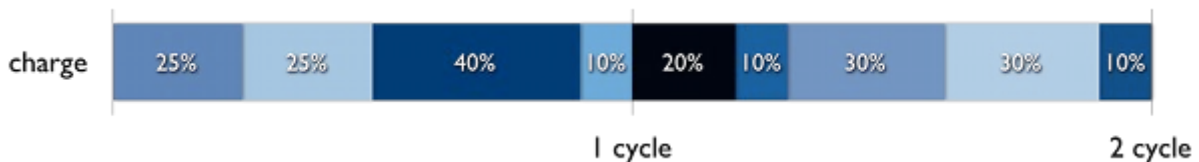

## **Avoid extreme ambient temperatures**

Your instrument is designed to perform well in a wide range of ambient temperatures, with 5° to 25° C as the ideal comfort zone. It's especially important to avoid exposing your instrument to ambient temperatures higher than 35° C, which can permanently damage battery capacity. That is, your battery won't power your device as long on a given charge. Charging the device in high ambient temperatures can damage it further. Even storing a battery in a hot environment can damage it irreversibly. When using your device in a very cold environment, you may notice a decrease in battery life, but this condition is temporary. Once the battery's temperature returns to its normal operating range, its performance will return to normal as well. Store it half-charged when you store your instrument long term

If you want to store your device long term, two key factors will affect the overall health of your battery: the environmental temperature and the percentage of charge on the battery when it's powered down for storage. Therefore, we recommend the following:

- Do not fully charge or fully discharge your instrument's battery - charge it to around 50%. If you store a device when its battery is fully discharged, the battery could fall into a deep discharge state, which renders it incapable of holding a charge. Conversely, if you store it fully charged for an extended period of time, the battery may lose some capacity, leading to shorter battery life.
- Place your instrument in a cool, moisture-free environment that's less than 32° C.
- If you plan to store your device for longer than six months, charge it to 50% every six months.

## Keys and User interface

### Main menu navigation keys

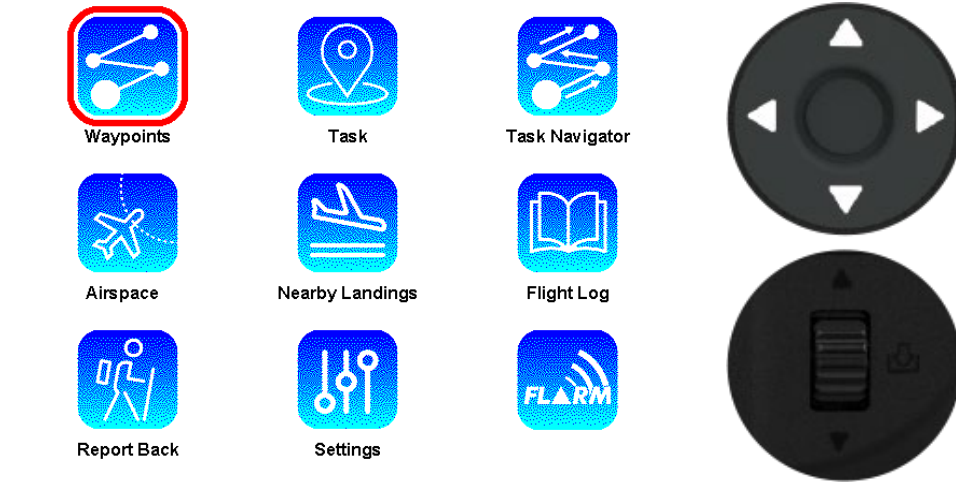

Use Map pan keys or scroll wheel do choose option. Push enter/mark key or push scroll wheel down to select.

### List type menu

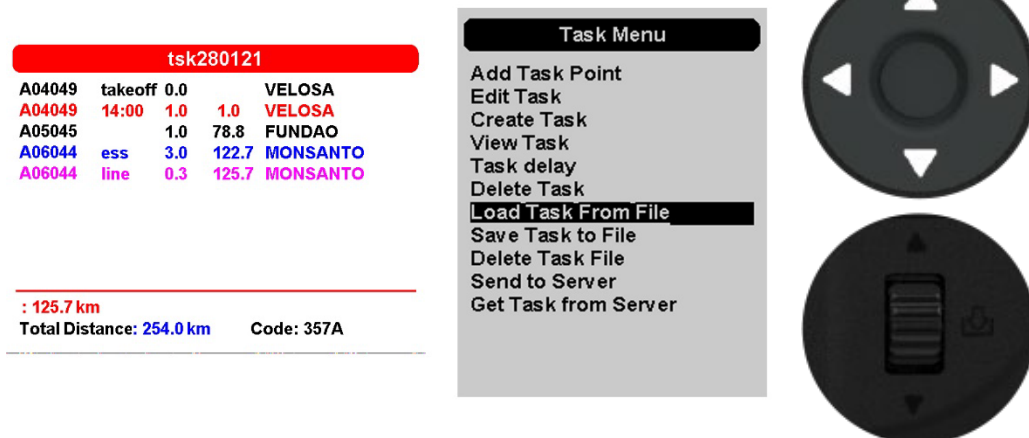

Use Map pan keys (up and down only) or scroll wheel do choose option. Push enter/mark key or push scroll wheel down to select.

### Setting the volume

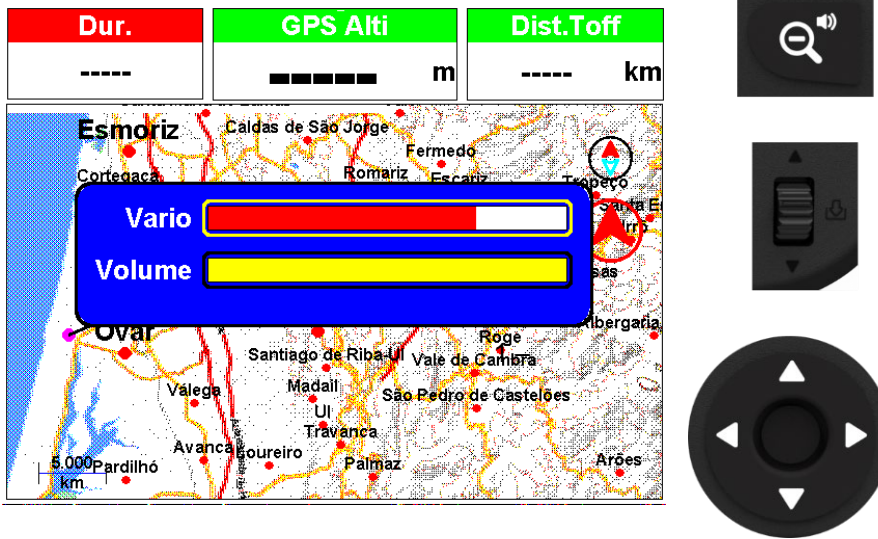

- 1 – Long press Zoom out/ sound key
- 2 – Use Scroll wheel to change the volume
- 3 – Use Up and down key to change between Vario and Volume (voice assistance)
- 4 – Press Enter to accept and exit setting volume mode

### Zoom and pan map object

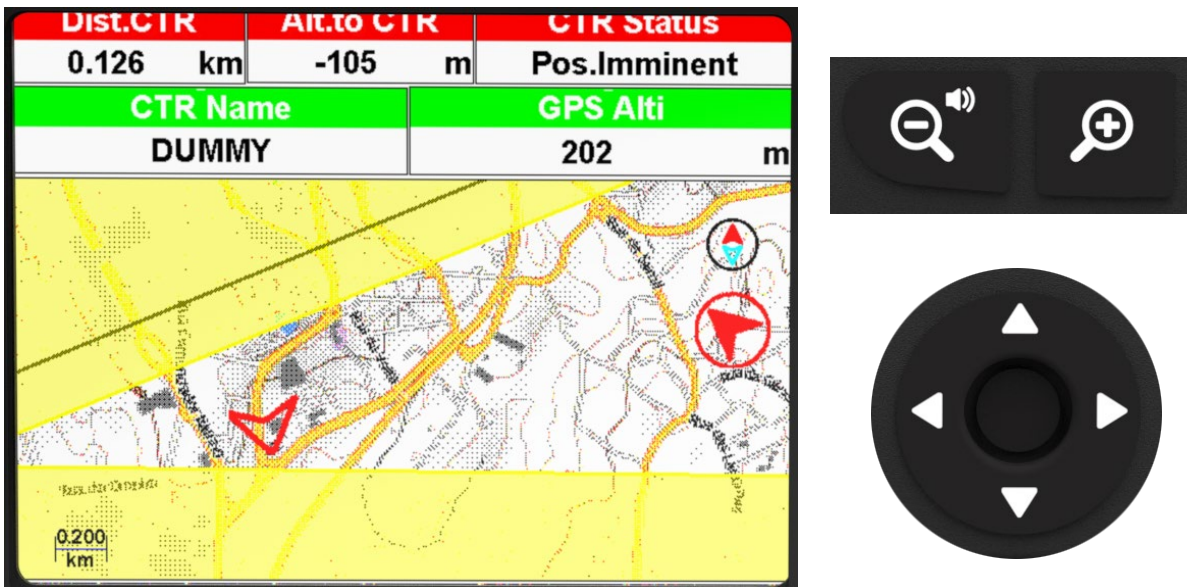

In any layout that contains a Map object is possible to Zoom with dedicated zoom keys. It's possible to pan using the cursor keys.

## Default Pages

Flymaster DS allows you to design up to 8 page sets using the Flymaster Instrument Manager. In flight you can change pages manually using the FN key. On the following pages we will show which pages Flymaster designed and which will be default to the instrument.

The description of each data field is available in this user manual in the section “available data fields”.  
The description of each object is available in this user manual in the section “objects”.

### Page 1

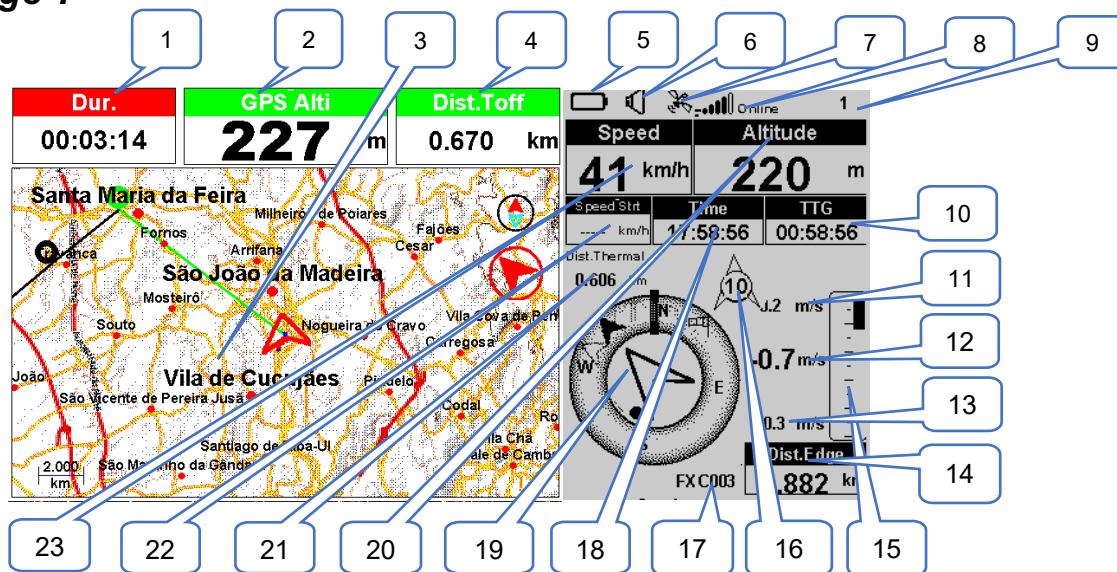

- 1 – [DUR.](#)
- 2 – [GPS Alti](#)
- 3 – [DUR. Flight Duration](#)
- 4 – [Dist. Toff](#)
- 5 – [Battery indicator](#)
- 6 – [Volume indicator](#)
- 7 – [GPS status](#)
- 8 – [GSM status](#)
- 9 – [Page number](#)
- 10 – [TTG \(time to go\)](#)
- 11 – [Max. Climb](#)
- 12 – [Ave. Vario](#)
- 13 – [Max. Sink](#)
- 14 – [Dist. Edge](#)
- 15 – [Vario](#)
- 16 – [Wind Arrow](#)
- 17 – [Active waypoint](#)
- 18 – [Time](#)
- 19 – [Navigation wheel](#)
- 20 – [Altitude](#)
- 21 – [Dist. Thermal](#)
- 22 – [Map Layer \( Task Map, Thermal map, road maps\)](#)
- 23 – [Speed](#)

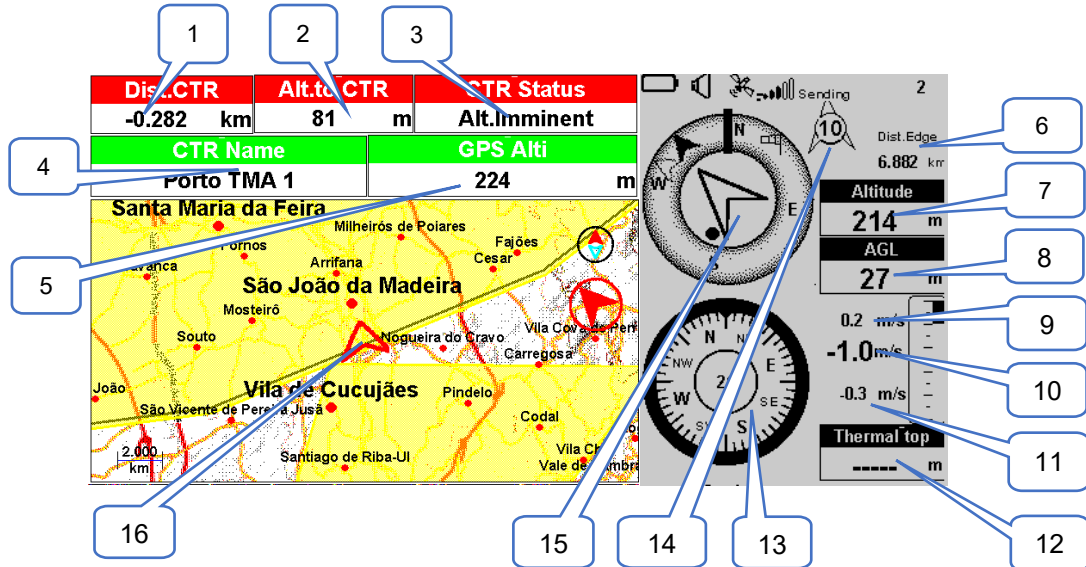

- 1 – [Dist CTR](#)
- 2 – [Alt. to CTR](#)
- 3 – [CTR Status](#)
- 4 – [CTR Name](#)
- 5 – [GPS Alti](#)
- 6 – [Dist. Edge](#)
- 7 – [Altitude](#)
- 8 – [AGL](#)
- 9 – [Max. Climb](#)
- 10 – [Ave. Vario](#)
- 11 – [Max. Sink](#)
- 12 – [Thermal Top](#)
- 13 – [Compass](#)
- 14 – [Wind Arrow](#)
- 15 – [Navigation Wheel](#)
- 16 – [Map Layer \( Airspaces , topo/roads map\)](#)

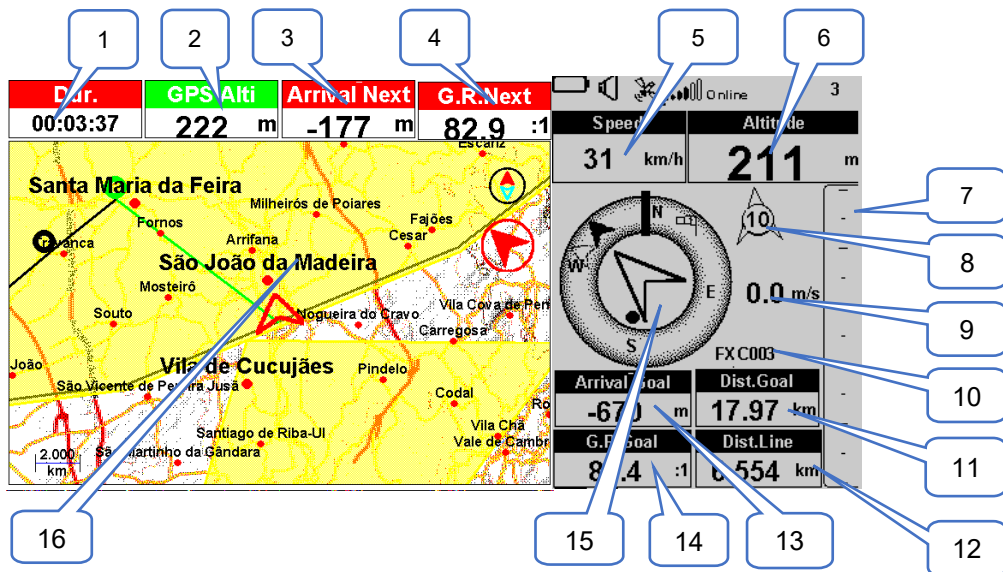

- 1 – [DUR.](#)
- 2 – [GPS Alti](#)
- 3 – [Arrival Next](#)
- 4 – [Glide Ratio Next](#)
- 5 – [Speed](#)
- 6 – [Altitude](#)
- 7 – [Vario](#)
- 8 – [Wind Arrow](#)
- 9 – [Ave. Vario](#)
- 10 – [Active waypoint](#)
- 11 – [Distance to Goal](#)
- 12 – [Distance to Line](#)
- 13 – [Arrival Goal](#)
- 14 – [Glide R. to Goal](#)
- 15 – [Navigation wheel](#)
- 16 – [Map Layer \( Task Map, airspaces, topo map\)](#)



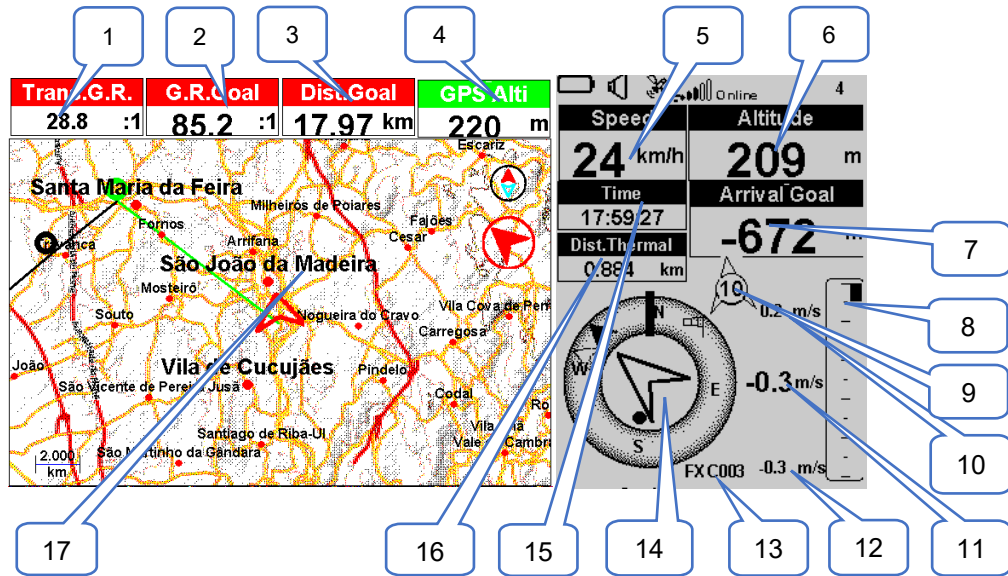

- 1 – [Transition G.R.](#)
- 2 – [Glide Ratio to Goal](#)
- 3 – [Dist. To Goal](#)
- 4 – [GPS Altitude](#)
- 5 – [Speed](#)
- 6 – [Altitude](#)
- 7 – [Arrival Goal](#)
- 8 – [Vario](#)
- 9 – [Wind Arrow](#)
- 10 – [Max. Climb](#)
- 11 – [Ave. Vario](#)
- 12 – [Max. Sink](#)
- 13 – [Active waypoint](#)
- 14 – [Navigation wheel](#)
- 15 – [Time](#)
- 16 – [Dist. Thermal](#)
- 17 – [Map Layer \( Task Map, topo map\)](#)

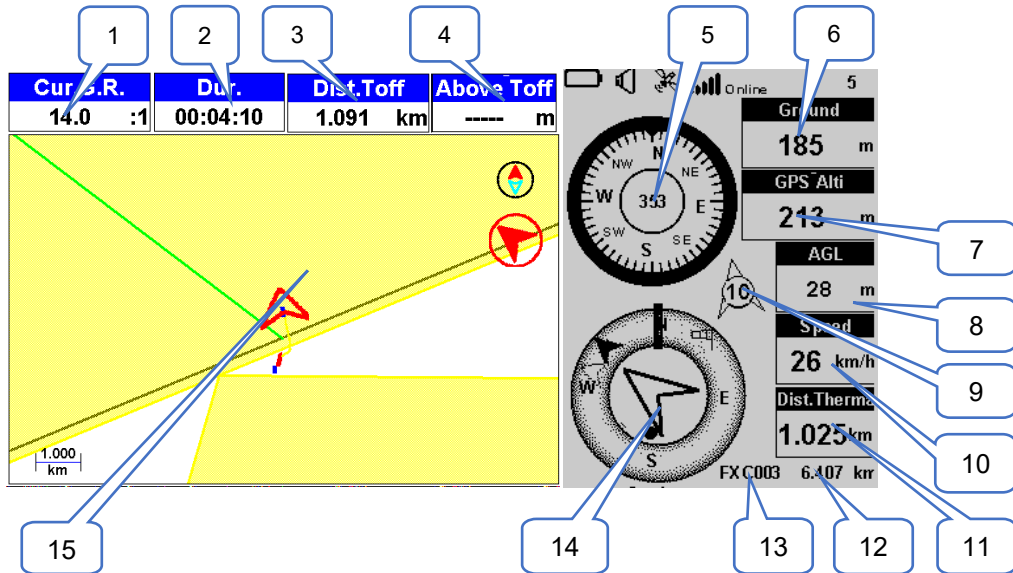

- 1 – [Current G.R.](#)
- 2 – [Duration](#)
- 3 – [Dist. Take off](#)
- 4 – [Above Take-off](#)
- 5 – [Compass](#)
- 6 – [Ground](#)
- 7 – [GPS Alti.](#)
- 8 – [AGL](#)
- 9 – [Wind Arrow](#)
- 10 – [Speed](#)
- 11 – [Distance to Thermal](#)
- 12 – [Distance to Line](#)
- 13 – [Active waypoint](#)
- 14 – [Navigation wheel](#)
- 15 – [Map Layer \(Airsaces Map, Task Map, Thermal Trace map\)](#)

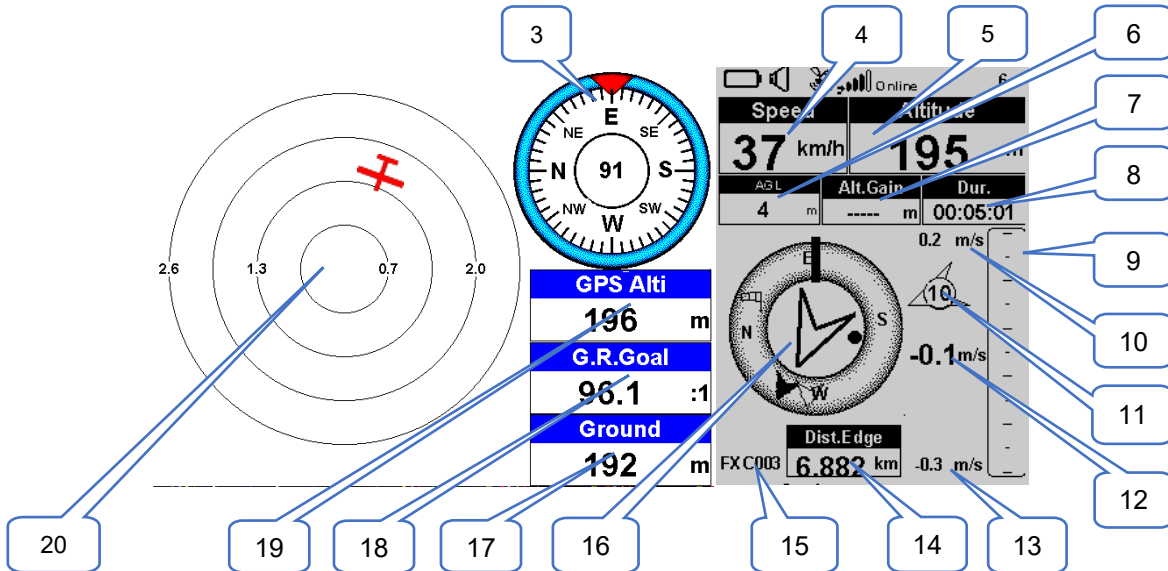

- 3 – [Compass](#)
- 4 – [Speed](#)
- 5 – [Altitude](#)
- 6 – [AGL](#)
- 7 – [Altitude Gain](#)
- 8 – [Duration](#)
- 9 – [Vario](#)
- 10 – [Max. Climb](#)
- 11 – [Wind Arrow](#)
- 12 – [Ave. Vario](#)
- 13 – [Max. Sink](#)
- 14 – [Distance Edge](#)
- 15 – [Active waypoint](#)
- 16 – [Navigation wheel](#)
- 17 – [Ground](#)
- 18 – [G. R. to goal](#)
- 19 – [GPS Altitude](#)
- 20 – [Flarm Aware radar](#)

## Available data fields

<b>A.OverGoal</b>	Altitude over goal is the difference between the current <u>altitude</u> and the goal's altitude based on barometric pressure values.
<b>Above Toff</b>	Altitude above takeoff is the altitude over the flight starting point.
<b>Abs.Pressure</b>	Absolute atmospheric pressure value in Pascals.
<b>Active waypoint</b>	Active turnpoint name.
<b>AGL</b>	Altitude above ground current location, using GPS altitude as reference.
<b>Alt.Gain</b>	Altitude Gain. Altitude gained in current thermal.
<b>Alt.Gain/Loss</b>	Altitude Gain/Loss. When at the top of the thermal displays the altitude gained from the base of the thermal, else displays the altitude lost since reaching the top of thermal.
<b>Alt.to CTR</b>	Altitude to CTR shows altitude to controlled airspace, a negative number indicates we must sink to come out of controlled airspace.
<b>Altitude</b>	Current altitude. This altitude is calculated based on the barometric pressure and depends on the QNH value.
<b>Altitude2</b>	Second Altimeter which can be set independently to the main altimeter.
<b>Arrival Goal</b>	Estimated arrival height above Goal. The height is calculated considering the average glide ratio that has being made. This means that wind, day quality and glider performance are used in the calculations.
<b>Arrival Next</b>	Estimated arrival height above the next waypoint. This means that wind, day quality and glider performance are used in the calculations.
<b>Ave.Speed</b>	Average ground speed calculated using a filter to show a smoothed speed, eliminating erratic speed changes due to glider pitching, etc.
<b>Ave.Vario</b>	Average Vario calculated using an integration time constant in order to indicate smoother climbing rates.
<b>AveROT</b>	Average rate of turn in degrees per second.
<b>Battery</b>	Shows battery strength as a percentage of complete charge
<b>Bearing</b>	Current bearing in degrees.
<b>Ceiling</b>	Shows the upper altitude of the airspace causing the warning, i.e. airspace that you are violating or close to violating.
<b>Compass</b>	Angle between the magnetic North and the instrument.
<b>CTR Name</b>	Name of the airspace causing warning or violation.
<b>CTR Status</b>	Status message of airspace, will show "Violating" when in controlled airspace, "Imminent Alt" when close to entering airspace vertically or "Pos.Imminent" when close to entering airspace horizontally.
<b>Cur.G.R.</b>	Current glide ratio calculated using the average vario value, and average ground speed.
<b>Date</b>	Current date. This value is automatic set when the device gets a valid GPS Signal
<b>Dist.CTR</b>	Distance to controlled airspace. When more than one airspace area is in range the closest will be shown. When inside an airspace area the distance shown is to the closest edge.
<b>Dist.Edge</b>	Dist.Edge
<b>Dist.Goal</b>	Distance to goal is the total distance from the current position to the goal. The distance is calculated considering that the optimal route is made through all pending turnpoints.
<b>Dist.Line</b>	Distance to Line. Shortest distance to the waypoint line circle. Distance line corresponds to the Distance Next minus the waypoint radius.

<b>Dist.Next</b>	Distance to Next. Shortest distance to the waypoint center. Distance next corresponds to the Distance Line plus the waypoint radius.
<b>Dist.Start</b>	Distance to start. Shortest distance to the start cylinder.
<b>Dist.Thermal</b>	Shortest distance to last thermal core (thermal dot).
<b>Dist.Toff</b>	Distance to take off is the distance between the current point and the flight starting point.
<b>Dur.</b>	Flight Duration. Duration of the current flight.
<b>Flight Level</b>	Current altitude in hundreds of feet, based on a fixed QNH of 1013.25hPa.
<b>Floor</b>	Shows the lower altitude of the airspace causing the warning, i.e. airspace that you are violating or close to violating.
<b>G-Force</b>	Current G-Force being experienced by the pilot when using the Heart-G sensor.
<b>G.R.Goal</b>	Glide ratio to goal. Necessary glide ratio to reach the Goal considering that the optimal route through remaining waypoints is made.
<b>G.R.M.G.</b>	Glide ratio made good. The actual glide ratio towards the active turn point. It is calculated using the integrated vario, and the VMG.
<b>G.R.Next</b>	Glide Ratio to Next. Necessary glide ratio to reach the next turn point.
<b>G.R.Toff</b>	Glide ratio to takeoff. Necessary glide ratio to reach the take off.
<b>Goal Close</b>	Remaining time to goal close.
<b>GPS Alti</b>	Altitude reported by the GPS.
<b>Ground</b>	Height of the ground at current location.
<b>Heading</b>	Heading in degrees returned by GPS.
<b>Land In</b>	During competition tasks it is common, usually due to safety reasons, to have a "land by" time. The land by time is defined by adding a waypoint typically the goal to the already defined task, setting it as "Landing" and defining the time. "Land in" shows the amount of time remaining before having to be on the ground.
<b>Last Send</b>	Time elapsed since the last data packet for position was sent to the live tracking server.
<b>Latitude</b>	Current position latitude according to the format defined in the settings menu.
<b>Longitude</b>	Current position longitude according to the format defined in the settings menu.
<b>LPF</b>	Leading Points Factor
<b>Max. Altitude</b>	Maximum altitude reached during current flight. This is based on barometric altitude.
<b>Max. Climb</b>	Once a flight has started, it shows the maximum rate of climb encountered during the flight. This value uses the instantaneous rate of climb. This value is reset when the instrument is switched off.
<b>Max. Sink</b>	Once a flight has started, it shows the maximum sink encountered during the flight. This value uses the instantaneous vario. This value is reset when the instrument is switched off.
<b>Max.G</b>	Max Gforce reached during flight
<b>Max.Speed</b>	Maximum Speed (returned by GPS) reached during the flight. When the instrument is switched off this value is reset back to zero.
<b>Min. Altitude</b>	Minimum altitude reached during current flight. This is based on barometric altitude.

<b>Odometer</b>	Distance travelled in the current flight
<b>Page Num.</b>	Current layout active page number.
<b>Page</b>	Page name
<b>Speed</b>	Indicates ground speed. The speed is only available when the GPS receiver has a valid signal.
<b>Speed Strt</b>	Speed to Start. The speed at which the pilot must fly in order to reach the start gate exactly at its opening.
<b>Thermal top</b>	The highest point reached during the current thermal.
<b>Thrml.Perfo.</b>	Performance of the most recent thermal showing average rate of climb in most recent thermal.
<b>Time</b>	Current local Time. This value is automatic revised when the device gets a valid Gps Signal. (see Note 2)
<b>Trans.G.R.</b>	Glide ratio during transition. Average glide ratio during transitions between thermals.
<b>Triangle Size</b>	Size of possible triangle
<b>TTD</b>	Time to destination
<b>TTG</b>	The TTG field is dynamic and will vary according to the current flight status and type of task defined. It will show TTG (time to go) before start gate opening, and will then change to "SS" (Speed Section time) which is the time elapsed after the opening of the start. If no start gates are defined in the task, or no task is defined, then this field will show "Dur", which in this case is the time elapsed since takeoff. The takeoff event is triggered when ground speed exceeds 5km/h and a 3D fix is available.
<b>Turnpoint size</b>	Radius of the active turnpoint.
<b>Vario</b>	Instant vario value.
<b>VMG</b>	Velocity made good, is the speed at which the pilot is approaching the active turn point.
<b>Wind Dir.</b>	Wind direction in degrees, calculated from gps when drifting.
<b>Wind Speed</b>	Calculated wind speed using GPS speed.

## **Objects (Graphical Elements)**

Graphical elements are characterized by providing information in a graphical way. Most of the graphical elements have fixed dimensions, although their position can be altered. As the LIVE DS firmware evolves the list of Graphical Elements will likely grow. The current list includes the following graphical elements.

### ***Battery***



(available for colour and Monochrome display)

The Battery Element provides a graphical indication of the current battery level. This element has fixed dimensions.

### ***Volume indicator***



(available for colour and Monochrome display)

The volume indicator element provides a graphical indication of the current volume level. This element has fixed dimensions.

### ***Communication Status***



(available for colour and Monochrome display)

The communication status element, similarly to any mobile phone, provides an indication about the communications with our servers via GSM. It show the signal quality level and the connection status ( no service, online or sending data)

### **GPS**



(available for colour and Monochrome display)

The GPS Element provides graphical indication about the current GPS signal quality. Basically, the lower the PDOP value (position dilution of precision), the more accurate calculations are for determining position. Values bellow 3.0 are fairly accurate. The Pdp values can be seen in info page (select settings icon without pressing ENTER)

### **Vario**



(available for colour and Monochrome display)

When the LIVE DS detects that the pilot is climbing, a black bar starts to grow on the left, from the bottom of the scale to the top, with 0.1 m/s increments. The same bar grows on the right, from the top of the scale to the bottom, if sinking is detected.

This element can be resized.

### **Navigation wheel**

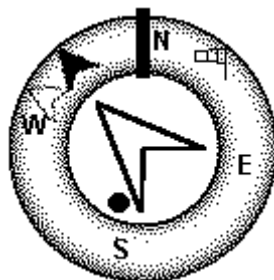

(available for colour and Monochrome display)

The Navigation wheel multi-information element which shows graphically the bearing, wind direction and thermal core. Additionally, if a destination was defined (waypoint) the navigation element will also indicates the direction to the waypoint centre, and waypoint edge and. This element cannot be resized but can be re-positioned.



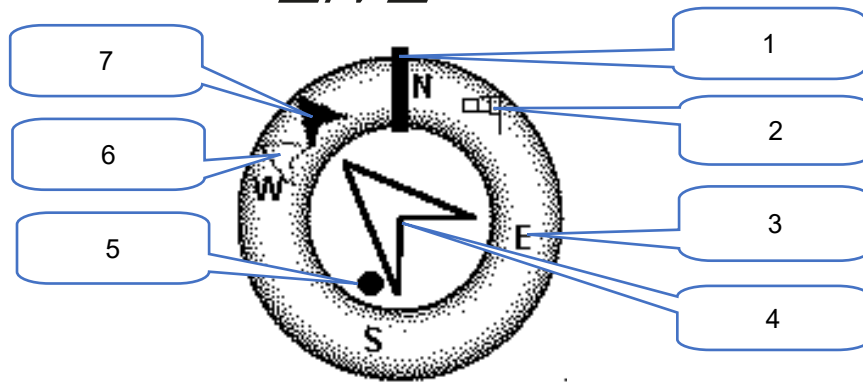

Navigation information is shown within the inner most circles. The external circle contains the cardinal points and the Wind Flag. The current traveling direction (bearing) corresponds to the point indicated in the top of the navigation circle. On the example shown in Figure, the bearing is approximately 350°.

- 1- Flight direction
- 2- Wind flag
- 3- Cardinal points
- 4- Navigation arrow (next TP)**
- 5- Thermal ball
- 6- Waypoint after the next**
- 7- Next TP center**

### Navigation Arrows

When a route is active the direction of next optimal point is pointed by an arrow (larger arrow 4). The optimal point corresponds to the unique point on the waypoint cylinder which lies along the optimal route .If no route is defined the arrow will start showing the direction to the take off', after the take Off' is detected (Take off)' is the point taken when the Flight Starts)

### Route Optimisation

During a competition task flight using the optimal tangent navigation saves a substantial amount of time. The smaller arrow 7 example points to the centre of next waypoint cylinder, and the arrow 7 points to the centre of the next Waypoint. The combination of all three arrows provides a spatial location of the pilot relative to the next 2 waypoints.

### Thermal Ball

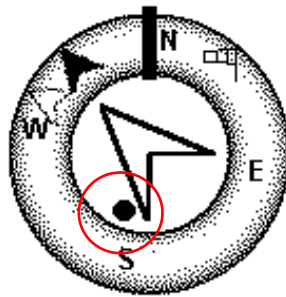

Another useful feature of the Navigation Circle Element is the thermal core ball. This map corresponds to a black dot which is shown inside the inner navigation wheel (together with the navigation arrows). During a thermal climb the LIVE DS keeps track of the strongest climb values point for each 50m layer. The point of strongest lift is then graphically represented by the black ball in the inner Navigation Circle, showing where the thermal core is relative to the pilot's position. The position of the dot (thermal core) is constantly updated as the pilot moves. When the pilot is over 300m from the thermal core the dot will be at the edge of the circle. As the pilot moves closer to the thermal core the dot will move towards the centre.

### Wind Flag

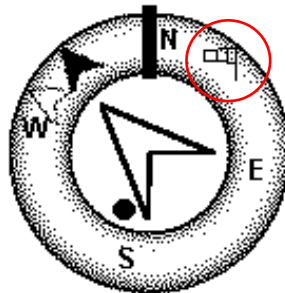

The external circle contains a small flag which indicates the Wind Direction relative to the pilot direction (direction the wind is coming from). For example, if the pilot is facing the wind then the flag is on the top of the circle. In the example of (Figure 3.5) the wind is blowing from Northeast.

## Multilayer Maps

Available for colour display

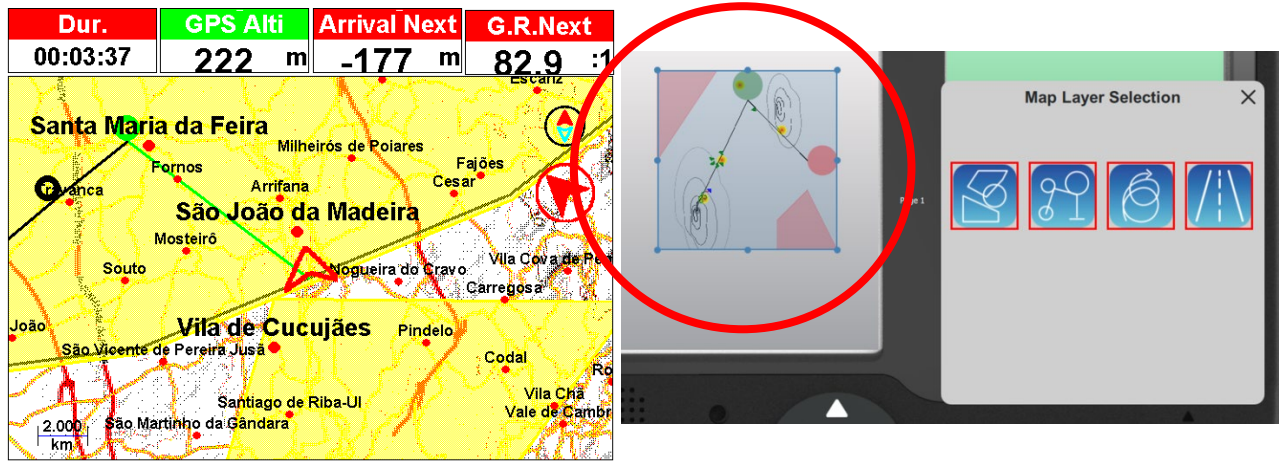

The Flymaster DS has [an object that can be configured through the Flymaster Instrument Manager called "Multilayer maps"](#).

This object is only available for use on the colour display. Various types of layers can be combined without any limitation between them.

All the available layers have two crucial small indicators of (North-South cardinal and Next Turn point direction)

As Live DS evolves in terms of firmware, more types of layers will emerge.

There are currently 4 available:

- Airspaces
- Task
- Thermal "trace map"
- Topo/road maps

### Airspaces

Once the flight starts, the map is redrawn with an arrow (representing the pilot) which will move around the map, indicating the relative position of the pilot to each of the airspace areas. Note that being inside an airspace area (2D) does not mean that the airspace is being violated, since the pilot can be above, or below the defined 3D shape. In order to have more information about possible airspaces violation, some data fields should be added to the layout. This data fields [Distance to CTR](#), [Altitude to CTR](#), and [CTR Status](#)

The airspace areas change colour from none, full yellow or full red, depending the status. No colour to normal, yellow for eminent and red for violating.

The Dist. CTR data **field** shows the shortest horizontal distance to the nearest airspace line. This distance is always positive. Similarly, the Alt. To CTR shows the shortest vertical distance to nearest airspace line. Unlike the horizontal distance, the vertical distance can be negative. A positive vertical distance indicates that you are outside the airspace, whereas a negative distance indicates that you are inside the airspace. Additionally, the CTR status **field** will indicate if an airspace is being violated by displaying Violating. If the pilot is not violating the airspace but it is inside a predefined margin then the messages Altitude Imminent, or Position Imminent will be shown.

**All the airspace warnings may be also audible though audio settings either voice or alarm.**

### **Wind Arrow**



(available for colour and Monochrome display)

When used in a layout an arrow is drawn showing the wind direction relative to the pilot direction (direction the wind is coming from). For example, if the pilot is facing the wind then the arrow points south (bottom of the screen). Centered over the arrow is a circle in which a number is displayed showing the wind speed. In the example above the wind is blowing from South. Both, the wind speed, and direction, value can be seen in a data fields.

### **Compass**

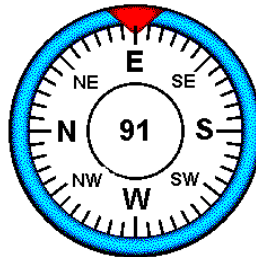

(available for colour and Monochrome display)

The Compass element shows all the data provided by the LIVE DS built-in magnetic compass. The compass includes a red top arrow which is always aligned with the LIVE DS. If the LIVE DS is turned the cardinal points will also turn in order the arrow tip points the right cardinal point.

In the example of Figure the LIVE DS is pointing almost to East. The direction is represented by the arrow, and also indicated numerically (91° degrees).

### **Flarm Aware Radar**

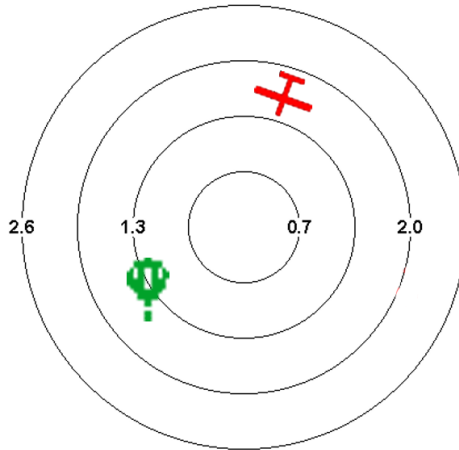

(available for colour display)

The Flarm Aware radar is graphical element that can be resized and re-positioned.

This graphic element allows you to visualize in a "radar" style the aircraft around you, in the range defined by the zoom level, equipped with a FLARM beacon.

[This service is optional.](#)

There are several types of aircraft in Flarm system, identified with different icons, depending on their category: they are Helicopter, Aeroplane and glider, Balloon and Drone.

If they are within the range defined by the zoom level, the aircraft will appear represented in different colours, depending on the threat level of a potential collision.

Green - Low risk of collision.

Yellow - Moderate risk of collision.

Red - High risk of collision.

**Paragliders and hang gliders will not be shown for obvious reasons. The close proximity that paragliders and hang gliders fly in would trigger constant alarms of potential collision.**



Waypoints

## Waypoints

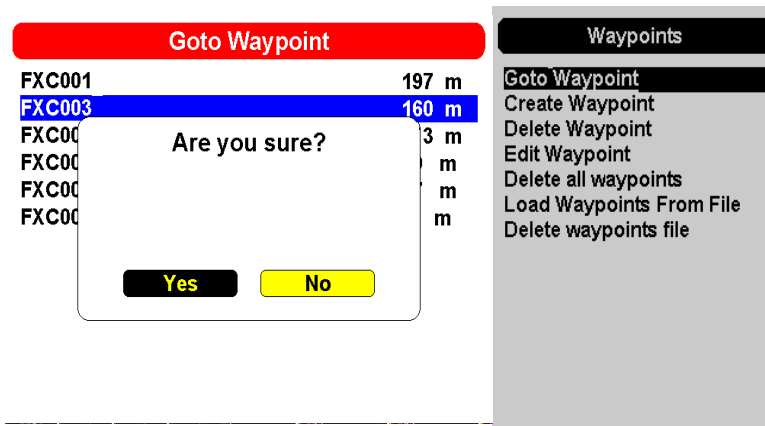

**Go to waypoint** - Forces navigation to the selected waypoint. This overrides the task navigation.

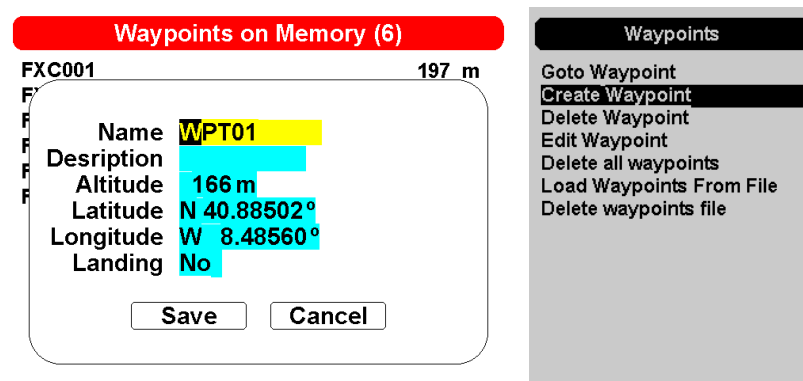

**Create Waypoint** - This menu allows the user to add a new waypoint to the waypoint list. If the GPS is fix, then the co-ordinates and altitude used for the waypoint are based on the current position. If “Landing” is set to YES, the waypoint will be considered as a landing place, and can be listed in “Nearby landings” feature.

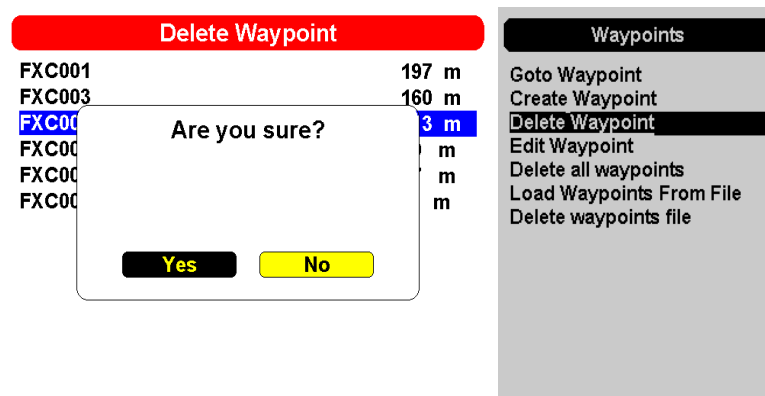

**Delete Waypoint** - It is possible to delete just a single waypoint on the LIVE DS from the waypoints list . Select the waypoint to be deleted. Once the waypoint is highlighted, press ENTER and press YES to confirm it's deletion. Waypoint will be removed from the waypoint list. If a waypoint is in use in the active Task, the task will be preserved. Also the waypoints file will not be changed.

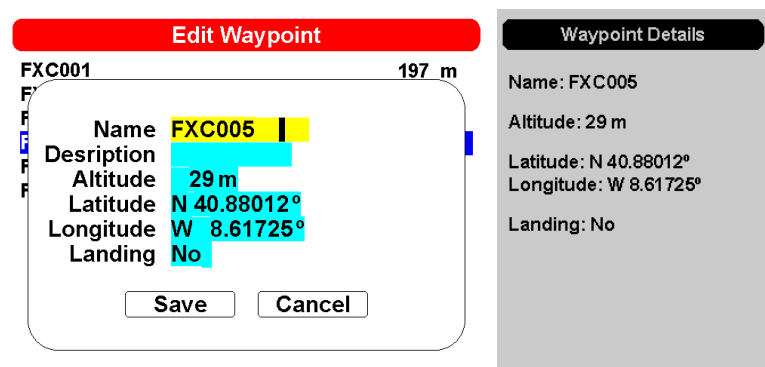

**Edit Waypoint** - Entering this menu allows the properties of the selected waypoint to be changed. The name of the waypoint can be changed, along with the elevation, latitude, longitude and if the waypoint is to be designated as a landing filed. To change any of the properties of the waypoint, first select the waypoint in the colour screen using navigation wheel. Press ENTER pulls up the menu allowing the waypoint to be edited. Use cursor keys and navigation wheel to edit. Press SAVE or CANCEL to quit editing.

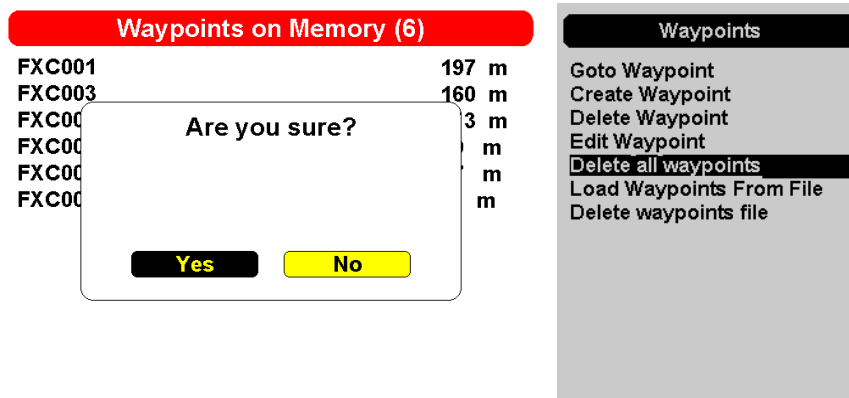

**Delete all waypoints** - It is possible to delete all waypoints on the LIVE DS from the waypoints list. All waypoint will be removed from the waypoint list. If a waypoint is in use in the active Task, the task will be preserved. Any saved task will be kept. Also the waypoints file will not be changed.

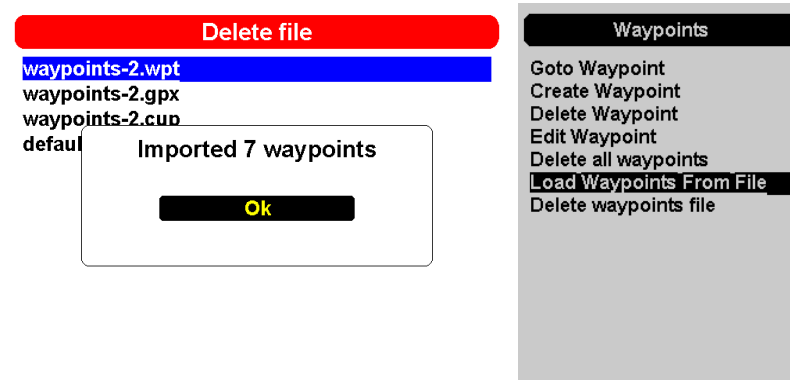

**Load waypoints from file** - You can load waypoints into the list from a file. Just copy a waypoints file to the SD card using Flymaster instrument Manager, of a known extension (GPX, GEO, WPT, CUP, etc). When selecting and pressing ENTER in the "Load Waypoints from file" function on the monochrome display, the points will be loaded into the list.



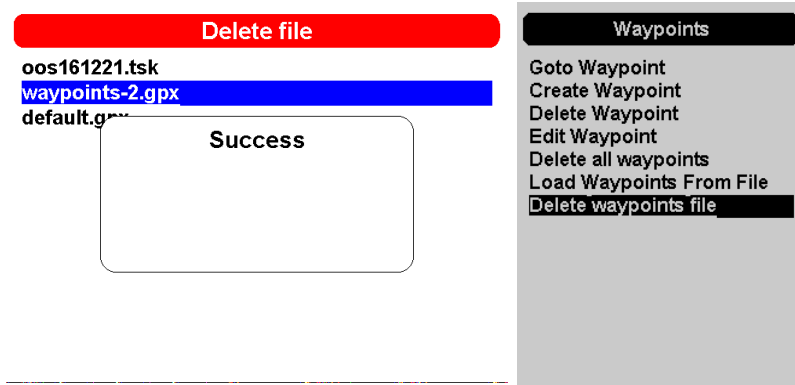

**Delete waypoints file**- It is possible to delete any waypoints file from the SD card , directly on the LIVE DS. If a waypoint is in use in the active Task, the task will be preserved. Any saved task will be kept.



Task

## Task

Type	Size	Name
FXC001	takeoff 0.0	0.0
FXC002		
FXC003		
FXC004		
FXC005		
FXC006		
FXC007		

Optimized Distance: 36.1 km  
Code: 8663

**Add Task Point** - To add a waypoint to the Task, select the waypoint that is to be added by pressing either the scroll wheel until the desired waypoint is highlighted. Pressing the ENTER button will add the point onto the Task on the colour display, at this moment the task point options for the newly added waypoint will appear in the task area, allowing to set several aspects of the task point (these can also be edited later).

Type	Size	Name
FXC001	takeoff 0.0	0.0
FXC001	17:00 0.4	0.4
FXC003	0.4	7.1
FXC004	0.4	9.8
FXC005	0.4	14.6
FXC006	ess 0.4	15.4
FXC007	goal 0.4	18.1
FXC002	0.4	32.2
FXC001	0.4	36.0

Optimized Distance: 42.6 km  
Code: 8663

**Edit Task-** There are 3 operations available for "edit task".

**Edit task point** - Entering this option, it is possible to choose the waypoint to edit from the active task on the colour display. You can change its characteristics for the Task when you select it.

**Reorder Task Points** - Allows you to reorder any point of the active task. After selecting the waypoint using Enter , you can move it within the Task waypoint list. Press Enter to "pin" it to the desired location in the list.

**Remove Task point** - Allows you to remove any waypoint from the Task, simply by selecting the desired waypoint and pressing ENTER.

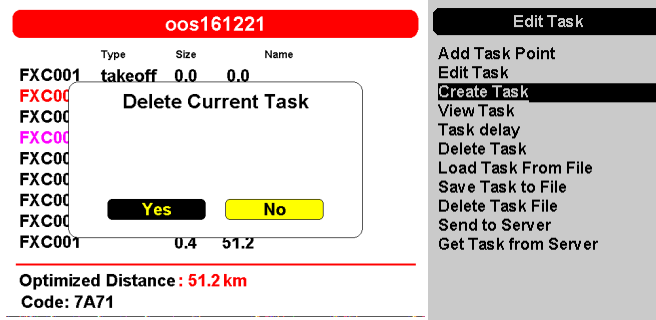

**Create Task** - This function allows you to create a task. Pay special attention that this operation erases the Task in use. If you want to use the current task again, you can save it to the SD card using the "Save Task to File" function.

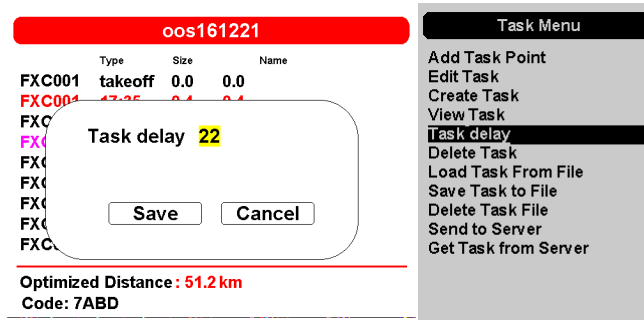

**Task Delay** - This feature allows you to, in a quick and efficient way, postpone the times of a Task. This way you don't have to go through all the trouble of editing the Task and manually changing the times. Use scroll wheel to change the value, press Esc/menu or choose Cancel to exit, or Enter SAVE to accept.

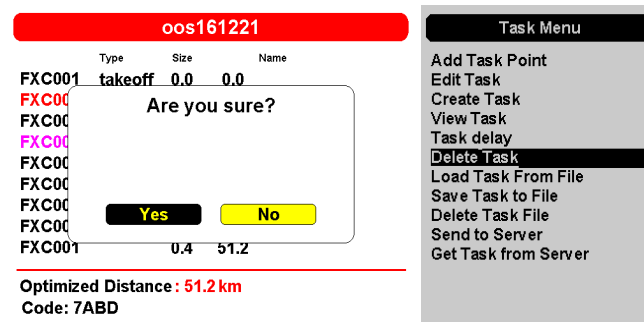

**Delete Task** - This feature allows you delete and clear the current active task. For free cross-country flying is recommended to erase any active task.

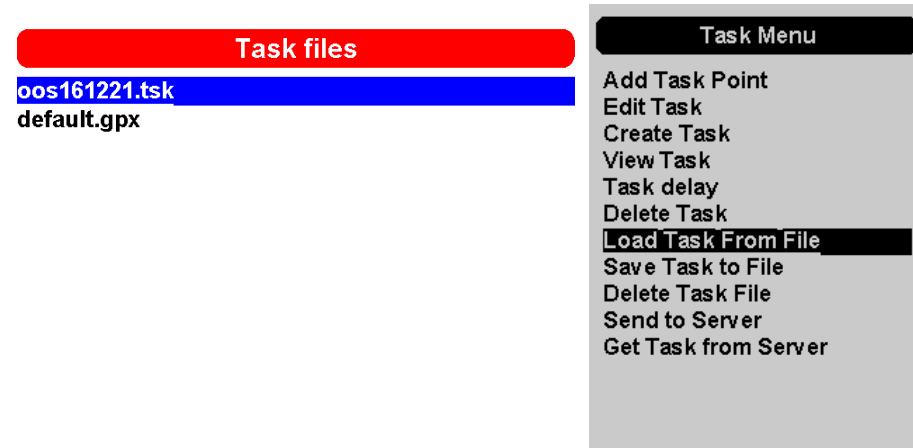

**Load Task from file** - This feature allows to load a saved task, and set it as the active task. Be aware that the current task will be erased. All the task files are stored in the SD card in the folder called “Waypoints”.

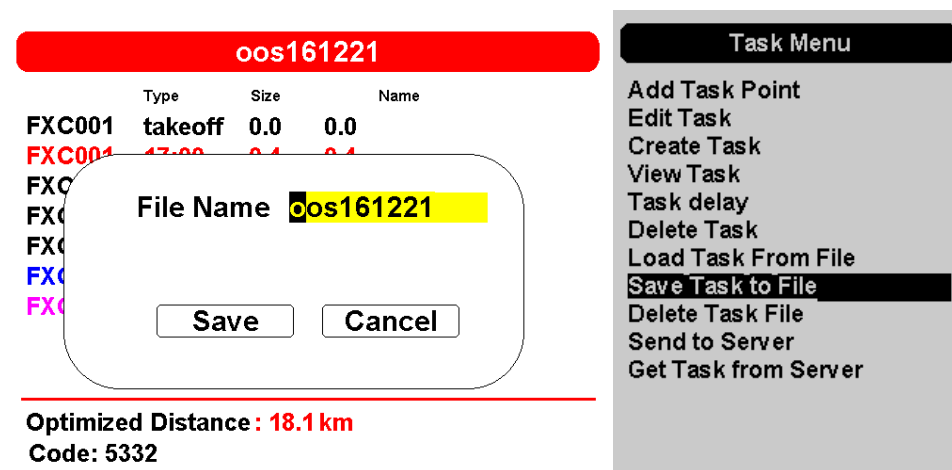

**Save Task to file** - This feature allows to save the active task to the SD card. Use scroll wheel to input the task file name, use Save or Cancel.

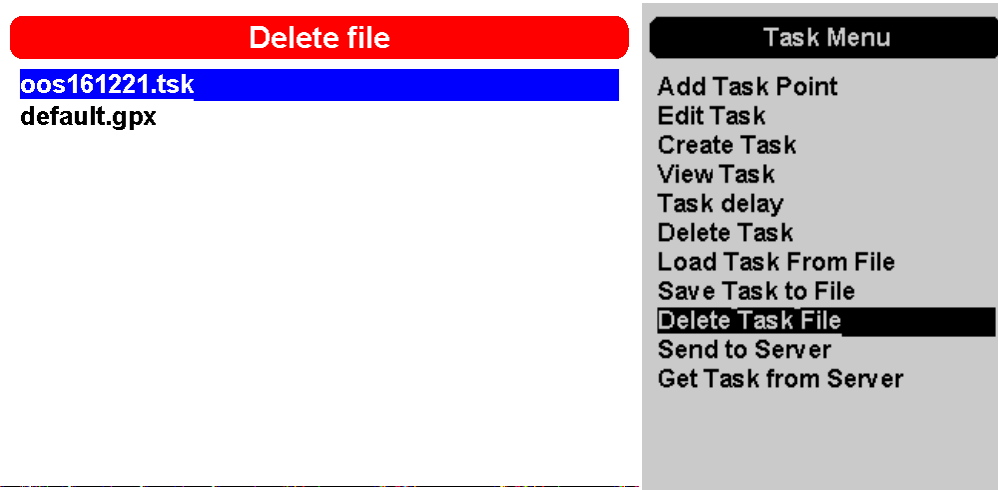

**Delete Task file** - This feature allows to delete a task from the SD card.

**Send to server** - This feature allows to upload the task to Flymaster servers. The Task can be received from other livetracking capable instruments inside the same group account, and be shown in livetrack360.com tracking.

**Get Task from server** - This feature allows to force a request of a task shared in a Flymaster group account.



Task Navigator

## Task Navigator

Task Navigator			
	Type	Size	
FXC001	takeoff	0.0	0.0
FXC001	17:00	0.4	0.4
FXC003		0.4	7.1
FXC004		0.4	9.8
FXC005		0.4	14.6
FXC006	ess	0.4	15.4
FXC007	goal	0.4	18.1

**Task Navigator** - This feature allows you to preview your entire task on the colour display. Scrolling through the list in the monochrome display using the Scroll wheel, the Turn points are being highlighted. You can use the zoom in, zoom out and pan keys to navigate the map and interact with it. Press ESC to exit Task Navigator.

Task Navigator			
	Type	Size	
FXC001	takeoff	0.0	0.0
FXC001	17:00	0.4	0.4
FXC003		0.4	7.1
FXC004		0.4	9.8
FXC005		0.4	14.6
FXC006	ess	0.4	15.4
FXC007	goal	0.4	18.1

During the flight, in the event of an error in the creation of the task or navigation error, you can access the task navigator, to "shortcut" to a certain turn point. Just access the "task navigator" use the scroll wheel or button up or down the cursor/pan and press enter at the desired point. The instrument starts navigating to the chosen turnpoint.



Airspace Browser

## Airspace Browser

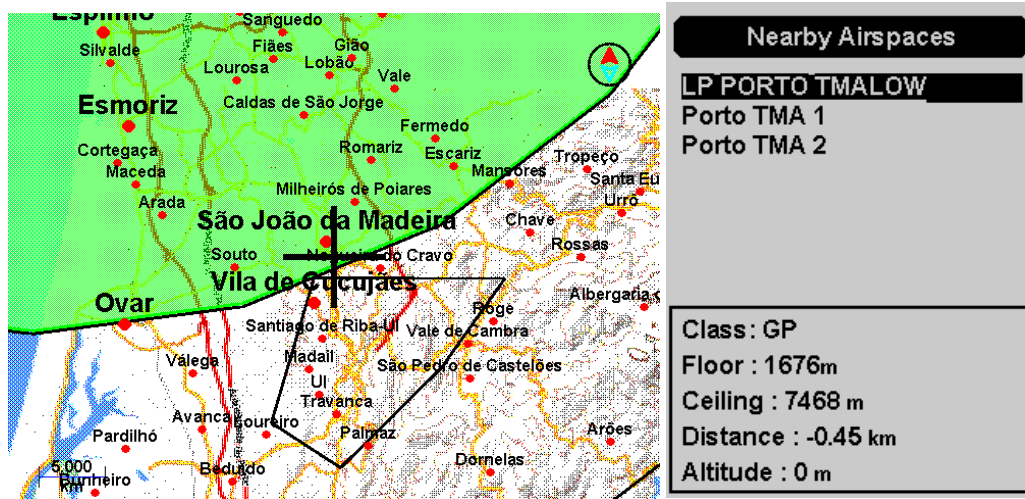

**Airspace Browser** - This feature allows viewing and interacting with all the airspaces contained in the instrument. By default, the list of airspaces in the monochrome display considers those closest to your current GPS position. If there is more than one, the list can be navigated using the scroll wheel, the airspace being shown in green in the colour display.

Using the zoom and pan keys, you can freely navigate the map, aiming the crosshairs, to the desired airspace. All the details of the same will always be shown on the monochrome display.



Nearby Landings

## Nearby Landings

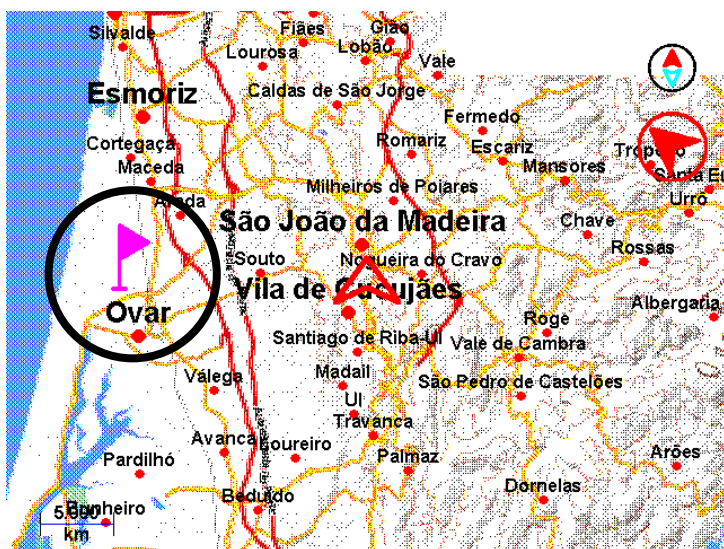

Nearby Landings		
	Distance	G.R.Next
FXC005	11.1	53.2

**Nearby Landings** - This feature allows you to view waypoints marked as "landing zone". To be considered and listed, the Waypoint must have the "landing" field set to YES. The waypoint(s) will appear on the colour display with a flag. The monochrome display will show the landings that are reachable (I.E. are below your position), their distance from your current position.

Edit Waypoint

<b>FXC001</b>		<b>197 m</b>
<b>Name</b>	<b>FXC003</b>	
<b>Description</b>		
<b>Altitude</b>	<b>160 m</b>	
<b>Latitude</b>	<b>N 40.93028°</b>	
<b>Longitude</b>	<b>W 8.55055°</b>	
<b>Landing</b>	<b>Yes</b>	
<input type="button" value="Save"/> <input type="button" value="Cancel"/>		



## Navigate to a Nearby landing

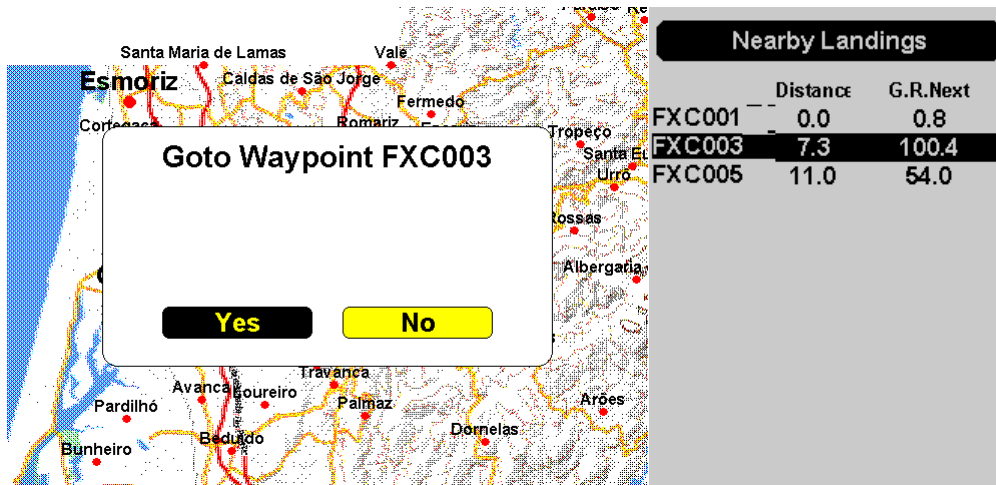

**Navigate** – After you choose the waypoint [tagged as “landing”](#) using the scroll wheel, push the wheel down or Enter to Navigate. Be aware that this navigation operation will override any task navigation.



Flight Log

## Flight Log

The Flight Log option allows the user to access information about previous saved flights. The colour display lists the flights stored in memory, listed by flight date. The list contains its position in the list, the start date of the flight and its duration. Using the scroll wheel or the up and down keys of the pan cursor allows you to choose the operation to be performed for each flight listed. Press Enter to perform the desired operation. Press Esc to exit.

Flights				Flight Log
30	2022-01-18	09:38:04	06:28:15	View Flight Details
29	2022-01-18	08:23:51	01:01:36	Delete flight
28	2022-01-17	18:29:25	00:00:44	Delete all flights
27	2022-01-17	17:55:42	00:33:09	Generate Flight IGC
26	2022-01-17	11:20:30	06:28:15	Send to Server
25	2022-01-11	11:08:46	01:20:20	
24	2022-01-04	10:17:08	06:28:15	
23	2021-12-23	12:22:31	00:02:43	
22	2021-12-21	11:00:56	00:00:33	
21	2021-12-21	11:00:17	00:00:17	
20	2021-12-21	10:59:38	00:00:30	
19	2021-12-21	10:58:47	06:28:15	
18	2021-12-21	10:54:38	00:00:02	

## View Flight Details

View Flight Details				Flight Details
30	2022-01-18	09:38:04	06:28:15	Date: 2022-01-17 17:55:42
29	2022-01-18	08:23:51	01:01:36	Duration: 00:33:09
28	2022-01-17	18:29:25	00:00:44	Max. Altitude: 272 m
27	2022-01-17	17:55:42	00:33:09	Min. Altitude: 9 m
26	2022-01-17	11:20:30	06:28:15	Takeoff Altitude: 68 m
25	2022-01-11	11:08:46	01:20:20	Max. Climb (Avg): 3.1 (1.4) m/s
24	2022-01-04	10:17:08	06:28:15	Max. Sink (Avg): -4.7 (-1.8) m/s
23	2021-12-23	12:22:31	00:02:43	Max. Speed: 100 km/h
22	2021-12-21	11:00:56	00:00:33	Distance: 15.2 km
21	2021-12-21	11:00:17	00:00:17	ESS Time: 01:24:14
20	2021-12-21	10:59:38	00:00:30	Goal Done
19	2021-12-21	10:58:47	06:28:15	
18	2021-12-21	10:54:38	00:00:02	

Flights can be selected using UP and DOWN keys or Scroll wheel. For the selected flight additional information is displayed on the monochrome display.

## Delete Flight

	Date	Start Time	End Time
30	2022-01-18	09:38:04	06:28:15
29	2022-01-18	08:23:51	01:01:36
28	2022-01-17	18:20:05	00:00:44
27	2022-01-17	18:20:05	00:00:44
26	2022-01-17	18:20:05	00:00:44
25	2022-01-17	18:20:05	00:00:44
24	2022-01-17	18:20:05	00:00:44
23	2021-12-21	10:58:47	06:28:15
22	2021-12-21	10:54:38	00:00:02
21	2021-12-21	11:00:17	00:00:17
20	2021-12-21	10:59:38	00:00:30
19	2021-12-21	10:58:47	06:28:15
18	2021-12-21	10:54:38	00:00:02

Selecting the Delete Flight option will delete the selected flight from memory. Before deleting the flight, a message is displayed asking the user to confirm the action. **VERY IMPORTANT: THIS OPERATION CAN NOT BE REVERTED, AND THE ERASED LOG IS LOST FOREVER.**

## Generate Flight IGC









	Date	Start Time	End Time
30	2022-01-18	09:38:04	06:28:15
29	2022-01-18	08:23:51	01:01:36
28	2022-01-17	18:20:05	00:00:44
27	2022-01-17	18:20:05	00:00:44
26	2022-01-17	18:20:05	00:00:44
25	2022-01-17	18:20:05	00:00:44
24	2022-01-17	18:20:05	00:00:44
23	2021-12-21	10:58:47	06:28:15
22	2021-12-21	10:54:38	00:00:02
21	2021-12-21	11:00:17	00:00:17
20	2021-12-21	10:59:38	00:00:30
19	2021-12-21	10:58:47	06:28:15
18	2021-12-21	10:54:38	00:00:02

By choosing this option, and pressing Enter on the desired flight, an IGC file with its proper digital signature will be generated for the micro SD card. These flights are saved in a folder called "igcs" at the root of the card. You can access them by connecting the instrument to your computer using it as a mass storage device or alternatively by removing the micro SD card from its slot and using a card reader. This last option is not recommended as handling the card directly can cause possible data corruption and lead to the instrument not starting.



Report Back

## Report Back

 Waypoints	 Task	 Task Navigator	<p><b>Current Position</b> GPS Status: No Fix</p> <p><b>GSM Status</b> Operator: 268 01 DATA 0 Signal Level: 3 Imei: 354679092583239</p> <p>Date: 2022-01-25 Time: 10:52:24 UTC offset: 0</p>
 Airspace Browser	 Nearby Landings	 Flight Log	
 Report Back	 Settings		

By selecting the icon in the main menu "report back", and without pressing enter, several important information will be displayed for an eventual sending of a report back.

The information is: **Current GPS position**, **GSM Status**, **Date**, **Time** and **UTC offset**.

Report Back Events		Report Back
11:17:26	Sent Level 3	Level 3
11:17:33	Sent Level 3	Level 2
11:17:38	Sent Level 3	Level 1
11:17:43	Sent Level 3	Do not need retrieve
11:17:48	Sent Level 3	<b>Need Retrieve</b>
11:17:52	Sent Level 3	Need Assistance
11:17:57	Sent Level 3	
11:18:02	Sent Level 3	
11:17:32	Pending Level 3	
11:17:32	Pending Level 3	
11:17:32	Pending Level 3	
11:17:32	Pending Level 3	

This feature allows the pilot to send pre-defined messages to the Flymaster server. The current firmware version includes messages which are useful in competitions. In order to send a message the pilot should enter the menu and select the desired message. The message is sent when the ENTER key is pressed. In the example Level 3 message is selected and sent many times. It's possible to see in the colour display the status of each message, pending or sent. This messages will be forwarded via SMS, Email, or Telegram to your configured recipients from your livetrack360.com account.



Settings

## Settings



Placing the main menu selector over this option, and without pressing enter, you will see all some important information about the status of your instrument such as: Serial number, Battery percentage, Charging status, Estimated time to full charge, estimated time of usage remaining, charging current , Gps Status, Pdp value and TTF (time for first fix).

**Serial number** – The serial number of your instrument

**Battery percentage** – The remaining percentage of battery capacity

**Charging status** – It shows the charger IC status: Charging, not charging or charged.

**Estimated time to full charge** – Estimates the time to achieve full charge while connected to a power source.

**Estimated time of usage remaining** – Estimates the remaining time left of usage .

**Charging current** – The current that the power source is supplying to the charging system.

**Gps Status** – Information about Gps status: No Fix, 2D or 3D fix.

**Pdp value** - DOP stands for Dilution of Precision. Strength of the current satellite configuration, or geometry, on the accuracy of the data collected by the GPS.

**TTF (time for first fix)** – is a measure of the time required for the GPS to acquire satellite signals and navigation data, and calculate a position solution (called a fix).

## Set Altimeter

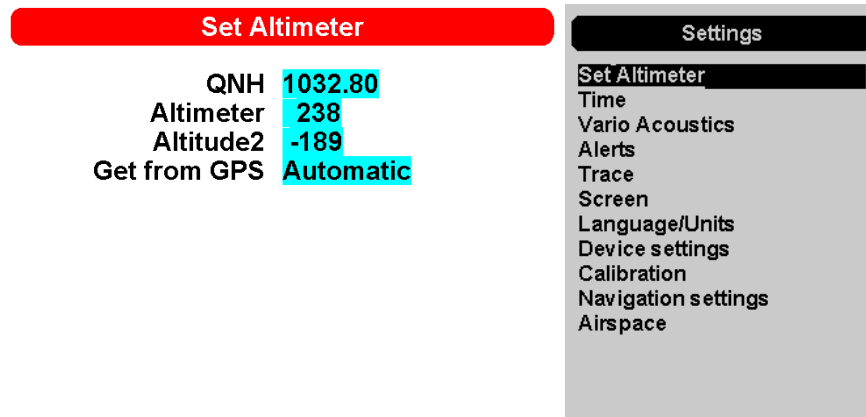

The Set Altimeter page, allows the user to adjust the barometric altimeter. A barometric altimeter calculates altitude based on atmospheric pressure, and should not be confused with the GPS altitude, which is calculated based on satellite information. Since atmospheric pressure can vary substantially with meteorological conditions, and so with time, the barometric altitude also varies accordingly. In order to have the correct altitude for a certain place the altimeter should be calibrated.

**Altimeter** - Calibrating the altimeter can be achieved by entering the known altitude of the location. Entering an altitude automatically calculates the QNH, which is the local barometric pressure adjusted to sea level.

**QNH** - Alternatively, the altimeter can be calibrated by adjusting the QNH for the local, and time. Changing the QNH will adjust the barometric altitude. Altitude can also be set from the GPS.

**Get from GPS** - Get from GPS field which can be set to Yes No or Auto. Adjusting this value to Yes will make the LIVE DS take the altitude from the GPS and adjust the altitude accordingly. The Yes is not stored in the setting, since it is a one time only operation. The Get from GPS can also be set to Auto, with this value being stored in the settings. When Auto is selected, after being turned On, the LIVE DS will automatically set the altimeter to the GPS altitude (once there is a valid GPS signal exists), or whenever the pdop value is lower than the previous one. Note that position dilution of precision (pdop) gives you an indication of how reliable the GPS altitude is at the moment. The lower the pdop value the more accurate the position fix.

## Time

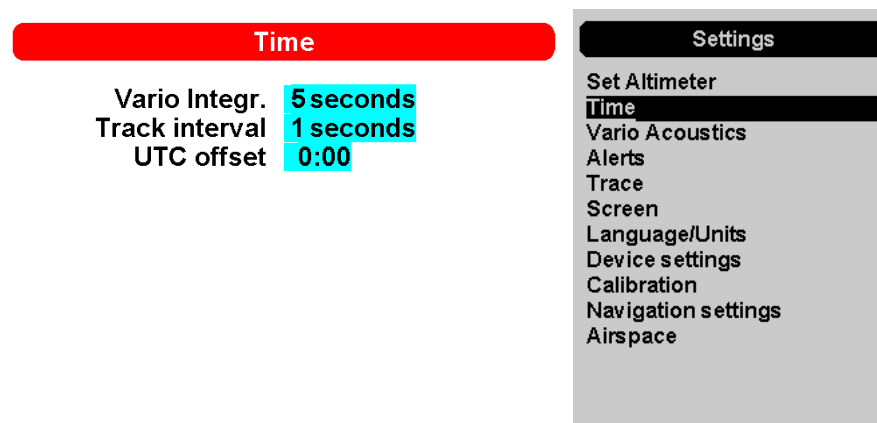

The Time page allows the user to set the vario integration time, track log parameters, and the Universal Coordinated Time (UTC) offset.

**Vario integrator** - The Integrated vario is calculated by integrating the vertical speed during a period of X seconds defined by this value. In the example, the integration period is 5 seconds (default value).

**Track interval** - During a flight the LIVE DS stores a track log point every track interval seconds. Track recording starts automatically when the Flight Starts, or 30 seconds before if using FAI COMP mode. However, when a task is active the LIVE DS will store a track log point immediately as it enters a turn point cylinder, Goal, or Start.

**UTC offset** - Using GPS data, the LIVE DS automatically adjusts the internal clock to the Universal Coordinated Time (UTC). The user should adjust the UTC offset so that the time displayed by the LIVE DS matches the local time.

### Vario acoustics

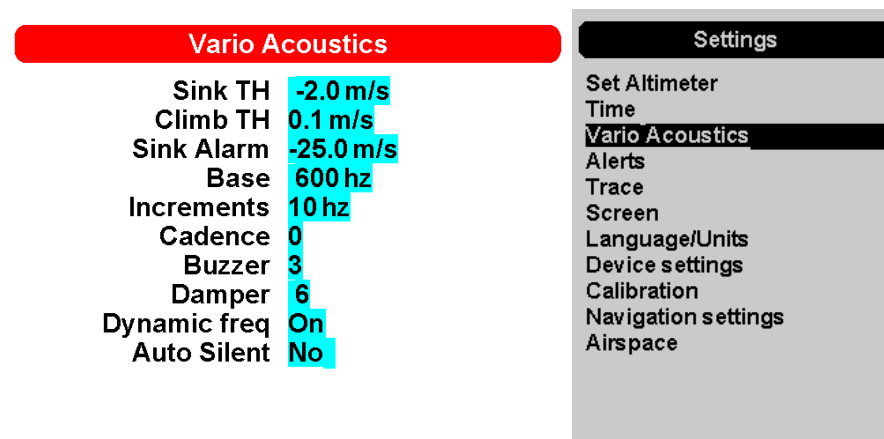

The Vario Acoustics settings menu option allows the user to change vario sound related parameters. The user can change the climbing, and sinking rate sound through the respective threshold values. These thresholds correspond to the climbing and sinking rates at which the sound activates. The user can also define in the the Acoustic Thresholds option the sink alarm and the sound volume of is the LIVE DS.

**Sink Threshold** - The Sink Threshold is the rate of descent at which the vario will emit a low frequency sound. Contrary to the climb sound the sink sound is continuous. The deeper the sink rate the lower the sound frequency. Default value for this parameter is -2 m/s, we suggest setting a value lower than the natural sink rate of the glider when flying with speed bar in still air.

**Climb Threshold** - The Climb Threshold defines the rate of climb at which the vario will start beeping. The frequency of the first beep is defined trough the Base Frequency parameter, and steadily increases according the Increments parameter value.

The default value for Climb Threshold is 0.1m/s. This means that beeping starts once the instantaneous vario value goes above 0.1m/s.

**Sink Alarm** - The Sink Alarm defines a vertical speed value at which a sound (alarm siren) starts to be produced. For example, if the Sink Alarm is set to -10m/s, then if the instantaneous vario goes below -10m/s, and alarm will be "red". This alarm can be used to identify high vertical speeds, as for example, in a

spiral dive. The Sink Alarm parameter can vary from 0 to -25m/s. Set the Sink Alarm to OFF to disable the alarm.

**Base Frequency-** The audio frequencies can be adjusted to match the user's preference, by setting the Base Frq and Increments.

The Base Frq is the first frequency used to produce the initial sound which corresponds to the climb threshold (by default 0.1 m/s). Later, as the climb rate increases, a bip, bip sound is produced for which the cadence, and frequency, also increase. The Base Frq can be set from 500 to 1500 Hz. The higher is the frequency value, the higher pitched the sound is.

In order to change the base frequency value press the ENTER key after the Audio Frequencies menu option is highlighted. This action will highlight the Base Frq value so it can be increased using the UP key, or decreased using the DOWN key. The ENTER key should then be pressed, thus confirming the Base Frq setting. The pre-set value for Base Frq is 700 Hz.

**Increments-** The Increments parameter sets the frequency increment for each 0.1 m/s climb rate increase. The increments can be set from 1 to 99 Hz. The pre-set value for Increments is 10 Hz.

Considering an Increments value of 10, and Base Frq of 700 Hz, the vario frequency at 1 m/s is 800 Hz.

**Cadence** - When a rate of climb is higher than that specified by the Climb threshold the LIVE DS creates a beeping sound. The rate (cadence) of the beeps increases as the climb rate increases. This increase in rate is not linear. The cadence parameter specifies which cadence curve should be used. Current there are 2 possibilities represented in the graph of Figure bellow.

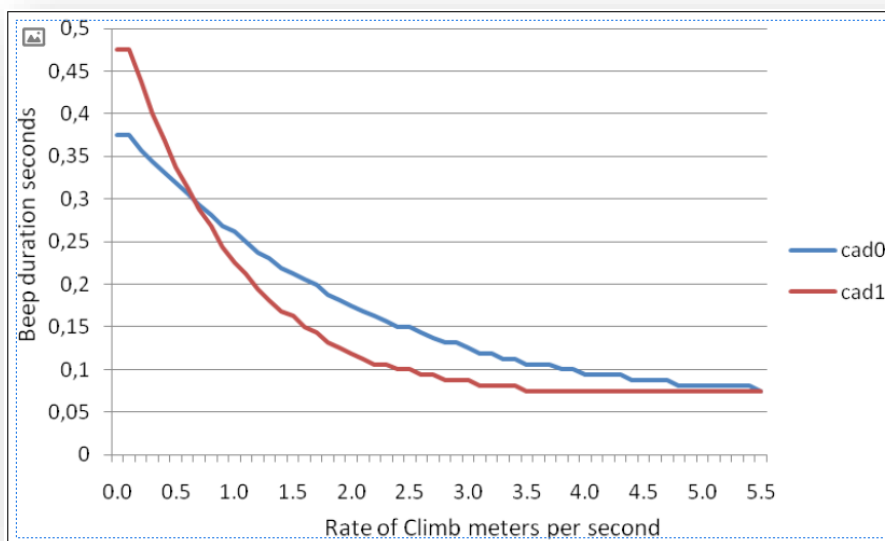

**Buzzer** - Is so called because of the sound it emits, which resembles a buzzing sound.

The buzzer sound is produced when the rate of climb is close to, but has not yet reached the specified Climb threshold. This value is set between 0 and 9 with each unit corresponding to be 0.1 m/s, ie. 3 is 0.3m/s. Subtracting this decimal value from the climb threshold will give us the value at which the LIVE DS will start buzzing. For example with the LIVE DS default values, Climb threshold=0.1m/s, and Buzzer=3 (0.3m/s) the buzzing will start at -0.2m/s because 0.1 - 0.3= -0.2. In this case at 0.1m/s directly below the Climb threshold the LIVE DS will emit a constant sound varying rapidly in pitch from around 100hz to the set base frequency at which the first beep is emitted. This is the buzzer sound and may resemble a growl noise. Setting the Buzzer value to 0 will disable the buzzer feature.

Although the Buzzer will sound very annoying on the ground it becomes an amazing companion in flight allowing the pilot to pick-up thermals he would have usually missed





A practical example of the advantages of the buzzer feature can be illustrated in Figure below. In this example both pilots are sinking at -1.0 m/s. The orange paraglider has a LIVE DS for which the climbing threshold is set to 0.1 m/s and the Buzzer parameter is set to 3 (0.3 m/s). The green paraglider has a typical vario for which the climbing threshold is set to 0.1 m/s.

As shown in the figure, when both pilots enter the thermal nothing is heard. The air is rising at 0.1 m/s but both pilots are descending at -0.9 m/s. In the second zone of the thermal the air is rising at 0.8 m/s, and so pilots are descending at -0.2 m/s. At this stage the orange pilot starts to hear the Buzzer brrrrr sound of his LIVE SD, which helps him to centre the thermal, while the green pilot is still unaware of the thermal. Finally, in the 3 zone, the air is rising at 1.2 m/s, and so both pilots climb at 0.2 m/s. The LIVE SD pilot starts to hear his vario beep... beep... sound, and it is only at this point the green pilot hears the first beep from his instrument.

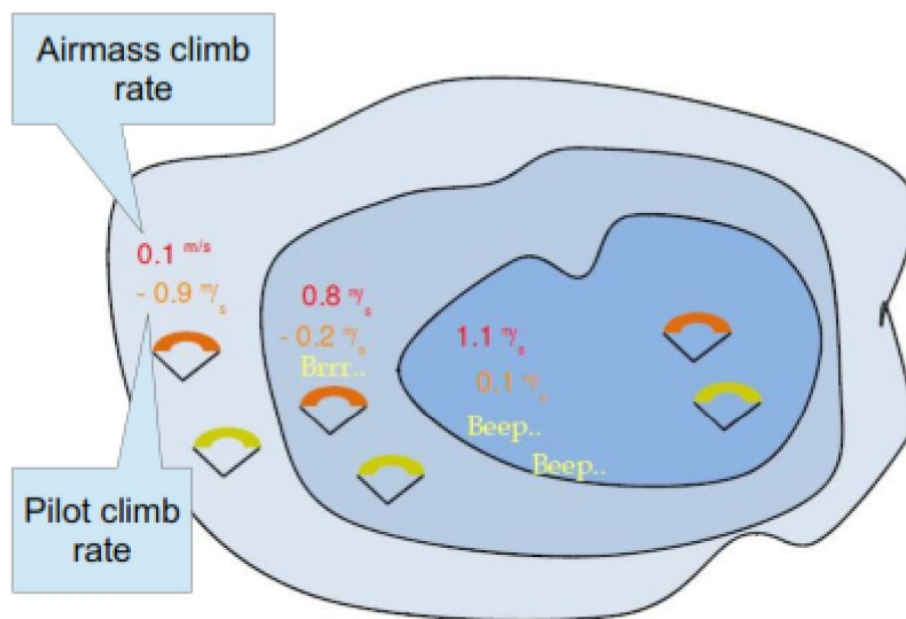

**Damper** - The LIVE SD 's vertical speed calculation is based on air pressure variations. It is very seldom to have air pressure absolutely stable. Turbulence caused by air moving near the sensor is sufficient to cause small variations in pressure. For this reason the LIVE DS filters (averages) the pressure data to prevent constantly detecting tiny pressure variations. The value that defines how much the pressure is filtered is the Damper. Setting a lower damper value causes the LIVE DS to become more responsive but harsher. Inversely a higher value causes the LIVE DS to be less responsive but smoother. The default value is 6.

**Dynamic Frequency**- The LIVE DS beeps at a specified pitch (frequency) when a certain rate of climb is encountered. When dynamic frequency is zero, the pitch (frequency) of that beep will remain constant if the rate of climb changes. With dynamic frequency on, the pitch of the beep may vary if the rate of climb varies during the individual beep.

**Auto Silent**- Setting Auto silent option ON will keep the LIVE DS 's vario quiet until a Start Flight has been detected. This function avoids listening the vario sound while waiting to take off. The audio will then be kept active until the LIVE DS is switched off. The default value for the auto silent parameter is ON.

## Alerts

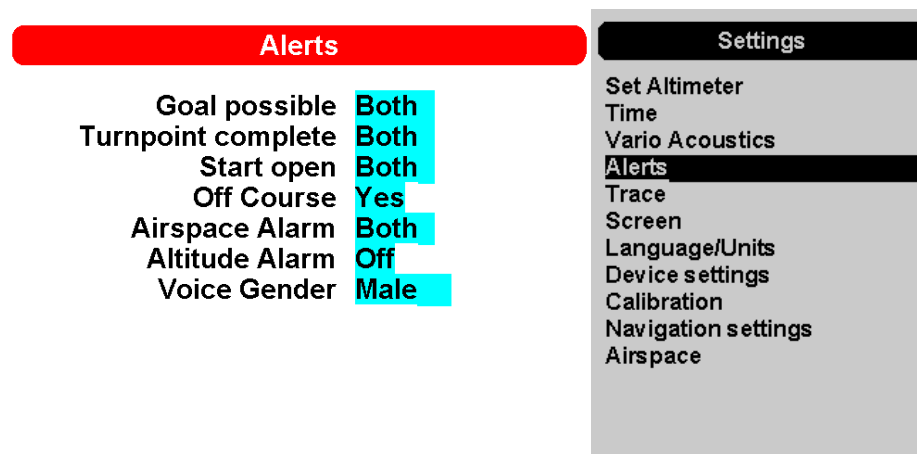

In this menu it is possible to set up the instrument to give you audio and voice (voice assistant) alerts when certain conditions have been met. There are 6 different possible alerts.

Each of these alerts can be enabled by selecting the YES, NO or Both (voice and alarm) using the nav wheel and press Enter to accept. Conversely, selecting NO will disable the respective alarm.

**Goal Possible-** A alarm (brrrr sound) and/or voice warning is made to indicate that it is possible to reach GOAL. This is based on having a positive number for Arrival Goal. This is calculated based on the average glide ratio and it takes into account wind.

**Turnpoint complete-** A alarm (brrrr sound) and/or voice warning is made indicating approaching or that the pilot has crossed a turnpoint.

**Start Open -** A siren type sound and/or voice is produced when the start time elapses. This tone or voice warning does not indicate that a successful start has been made just that the Start is open.

**Off Course -** Almost always when a pilot makes a throttle transition, his attention is focused 80% of the time on seeing the behaviour of the wing and looking at other focuses than the instrument. To help the pilot, the Live DS can warn with a voice assistant warning that the pilot is deviating from his ideal route. This warning is voice only whenever the heading is ideal or is deviating from it.

**Airspace alarm -** A siren type sound is produced and voice warnings indicating that the pilot has entered the buffer zone close to airspace.

**Altitude alarm -** A siren type sound is produced and/or voice warnings indicating that the pilot is approaching or has entered the altitude limit, described below.

**Altitude Limit -** It is possible to set a specific altitude alarm independently of the airspaces. In many occasions, in a competition, the airspaces can be ignored or they are reserved for the competition. But even so, there may be altitude limitations for the location, that can be set in this data field. Setting this value ([barometric altitude or GPS altitude, depending the settings in Ref. Altitude in airspace settings](#)), will set the altitude alarm.

**Voice gender -** It is possible to choose between Male and Female voice assistant.

## Thermal Trace map

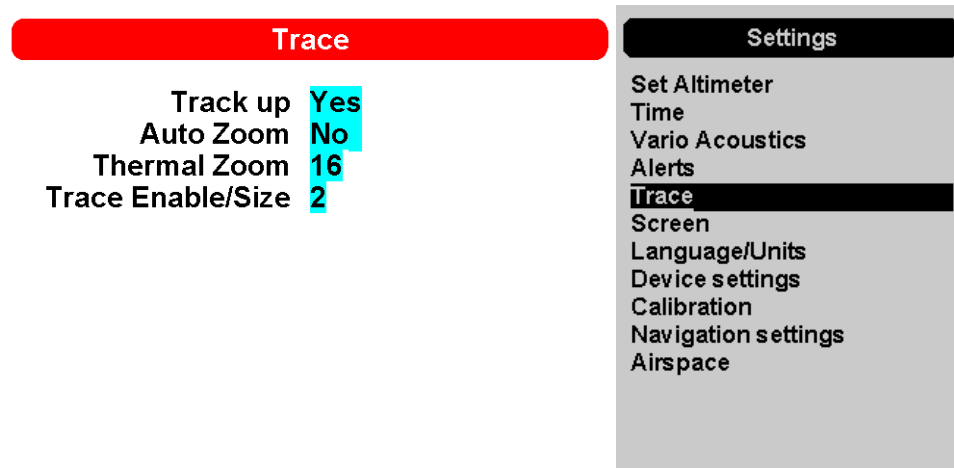

This options sets the behaviour of the traces drawn on the Thermal Trace map layer

**Track up** - Track up allows the trace to be displayed with either the track relative to North, or with the current heading to the top of the screen . When Track UP is OFF you will see the map turning around the pilot, while with North UP you will see the pilot moving around the Map.

**Auto Zoom** - Setting Yes causes the system to automatically zoom into the trace when entering a thermal, making it easy to understand the location of the thermal.

**Thermal Zoom** – Here you can define the automatic zoom level you want on the ["thermal map" layer](#). This value ranges from level 1 to 16 with 16 higher or more "zoomed".

**Trace Enable/Size-** With this option you can define what thickness you want to see on the "thermal map" layer. The value ranges from 1 (finest) to 3 (thickest). You can turn off the "thermal map" by setting the value to "Off".

## Language / Units

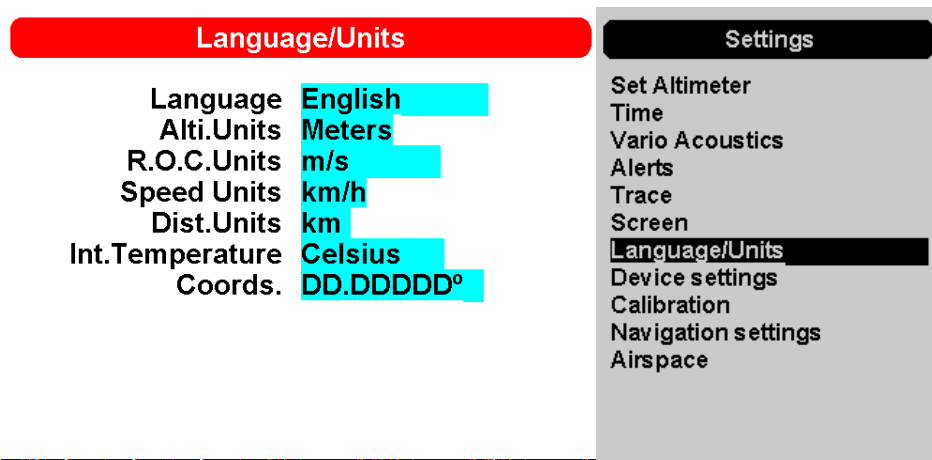

The Language and Units menu option allows the user to change the LIVE DS interface language and units. The UP, and DOWN keys from the pan/cursor keys, can be used to choose each option. Using the scroll wheel to change the setting. Pushing the ENTER key confirms the current field value, and highlights the following field. Push ESC to exit.

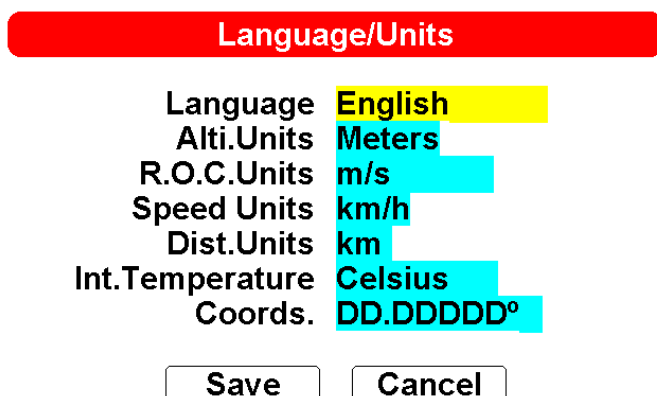

**Language** - Defines the interface language.

**Alti units** - Altitude Units. Altitude can be show in Meters, or Feet

**R.O.C. (Rate of climb)** - Rate of Climb Units. ROC can be show in m/s, or 10 x Feet/ min

**Speed Units** - Defines the interface language.

**Dist. Units** - Distance units can be in Km, or Miles.

**Temperature** - Temperature units can be Celsius or Fahrenheit.

**Coords.** - Coordinates format. These can be either.

DD°MM'SS; DD°MM.mmm'; DD.dddd; UTM

**Device settings**

**Device settings**

Factory settings	No
Reset now	No
Reset GPS	No
On Landing	Report Back
GSM modem	On

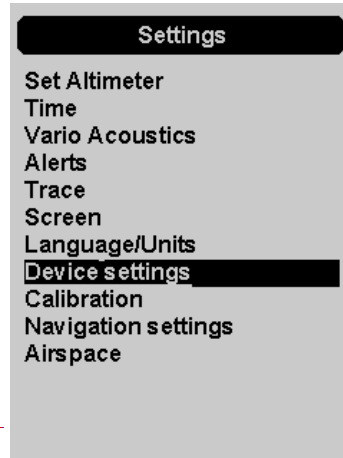

This menu option allows the user to execute some recovery functions. The UP, and DOWN keys from the pan/cursor keys, can be used to choose each option. Using the scroll wheel to change the setting. Pushing the ENTER key confirms the current field value, and highlights the following field. Push ESC to exit.

**Factory settings** - Reset all parameters to the default factory values. This will not change the layout to the factory default layout. Care should be taken because all settings made by the user are lost.

**Reset now** - Makes a hardware reset to the instrument.

**Reset GPS** – This will restart the GPS module and force a “cold start” from the module.

**On Landing** - In this data field you can choose the behavior of the instrument after detecting an eventual landing. There are 3 options:

Off - Does not perform any operation or pop up any options window

Report Back - A window appears with choices for the type of "report back" you want to send (see the "report back" section).

Auto-off - **The instrument turns off automatically. This option must be used with the utmost care as a false detection of a landing can lead to the instrument dislodging in an undesired way.**

**GSM modem** – This will allow to turn on/off GSM modem

## Calibration



The Live DS include a magnetometer and accelerometer sensor. Using these sensors the LIVE DS can provide G-Force and magnetic compass heading. Even though the compass is digital there is a tilt compensation algorithm that ensures accurate compass heading even when the LIVE DS is inclined. The Calibration menu option allows the user to calibrate the LIVE DS accelerometer and magnetometer sensors. Calibration is particularly important for the magnetometer since without it you will get inaccurate data from the compass. Despite all Flymaster instruments being factory calibrated errors can be introduced due to several external influences, such as the presence of strong magnetic fields or the time. In order to eliminate these errors a proper magnetometer calibration should be made. Calibration parameters are kept when the LIVE DS is turned off, reset or when a firmware update is done. The magnetometer calibration process is described below.

### Calibration



**Tilt instrument until all arrows are green**

### Calibration

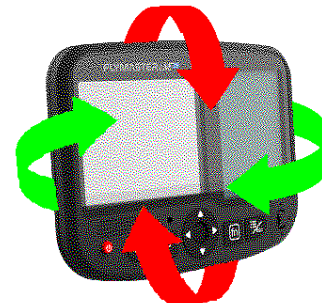

**Tilt instrument until all arrows are green**

After pressing enter in the "calibration" option, the colour display shows the indications of all the axes that the instrument must rotate. You must rotate the instrument in the 4 main axes 360 degrees or more. As each axis is calibrated, the indicator arrows turn green. At the end of the process, if successful, there is a

voice instruction indicating "calibration done". If unsuccessful, there is a voice prompt indicating "calibration failed". You must repeat the operation so that the magnetometer is properly calibrated.

## Navigation Settings

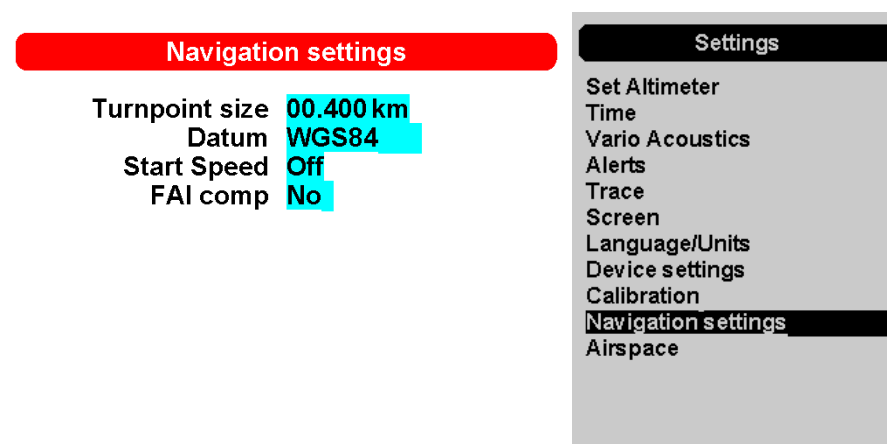

**Turnpoint Size** - The default turnpoint cylinder size is set in this menu. The size of the cylinder can be changed by scrolling through the numbers using the UP and DOWN keys. Pressing ENTER moves to the next digit. This value is used as the default cylinder size during task creation.

**Datum** - Two datum models can be set on the LIVE DS . Options available are WGS 84 and FAI sphere. At the start of any competition, be sure to check what Datum is used by the scoring system to ensure that the correct distances are being reported.

**Start Speed** - The start speed is one of the Start Flight conditions, and it is used to define the minimum GPS speed, in Km/h, that should be reached in order to initiate the flight. Note that the Start Flight event is important to many other functionalities, so care should be taken when setting this value. For example, if Auto Silent is on, the vario will only beep after the flight starts. The track data is also only saved after the flight starts. **If set to OFF the flight will start immediately after GPS fix position is acquired. This setting is only recommended in very exceptional occasions like walk-and-fly activities, because will produce a track log each time the instrument is turned on.**

**FAI comp** - Due to new FAI (CIVL) requirements regarding flight certification, when this setting is set to YES, the instrument is only ready to fly when there are at least 30 seconds of track log recorded with 3D GPS position before actually taking off . As long this requirement is not met, a message appears on the instrument with the message "WAIT" informing you not to take off. The same happens after landing, that the same 30 seconds of track log must be saved, and the instrument will only turn itself off after fulfilling this requirement.



## Airspace

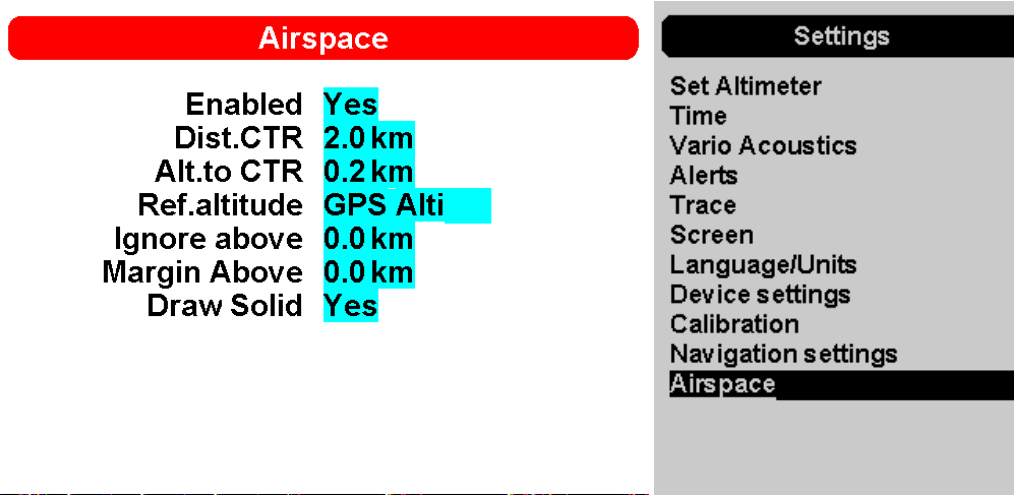

This menu allows the user to define certain parameters related with airspaces. Each of the parameters can be changed using the scroll wheel. Use cursor up and down keys to navigate between settings. Pressing the ENTER key confirms the value and jumps to next parameter. Changes can be undone by pressing the ESC key. As shown in Figure there are 7 parameters related to the airspace which are explained below.

**Enabled** - If this parameter is set to YES, all the Airspaces functions will be ON, including warnings and map layer representations.

**Dist. CTR** - Minimum horizontal distance that a pilot can be from an airspace without triggering an airspace warning. If this thresh-old is passed a warning is emitted.

**Alt. to CTR** - Minimum vertical distance that a pilot can be from an airspace without triggering an airspace warning. If this threshold is passed a warning is emitted.

**Ref. altitude** - The Ref. Altitude parameter allows the user to define the altitude that is used to evaluate the airspace's proximity. The parameter can be set to:

GPS Altitude - Altitude given by the GPS

Altitude - Barometric altitude

Flight Level - Barometric altitude expressed in hundreds of feet and computed assuming an International standard sea-level pressure datum of 1013.25 hPa (QNH).

**Ignore Above** - Here you can set from which altitude you can ignore airspaces. After setting a value above which they will be ignored, they will not be drawn nor will any alert or alarm be generated in the airspaces that are located above this value.

**Draw Solid** - With this option set to YES, in the map that contains an airspace layer, the violation (in red) or imminent violation (in yellow) will be filled.

## Load Airspace

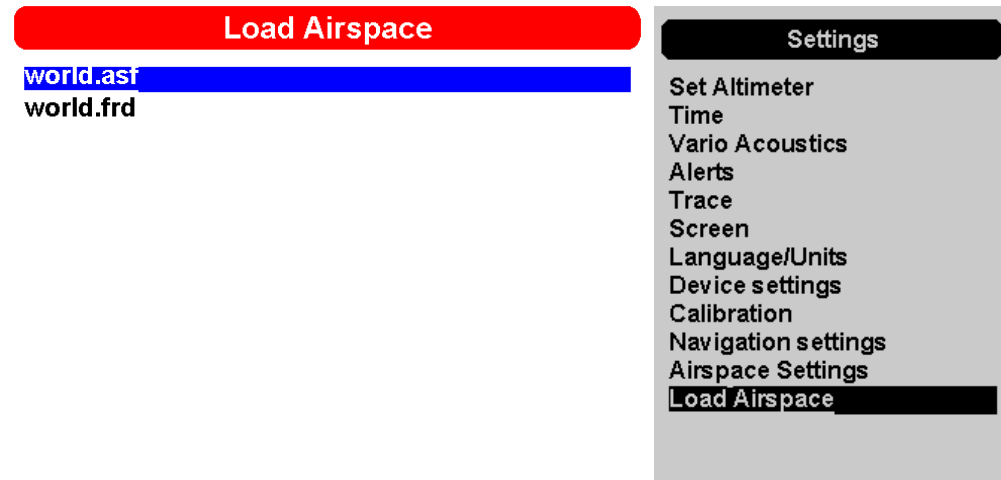

On many occasions and due to various factors, it is necessary to load additional airspaces. This option allows you to load airspaces in Open Air format into the instrument. The files can be saved to the memory card using the Flymaster Instrument Manager.

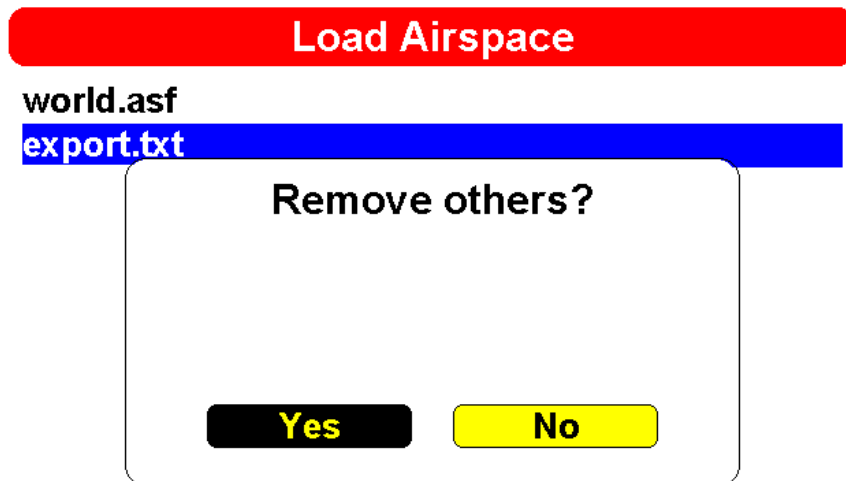

YES – All previously loaded airspaces (including the build-in World.asf) will be removed and only the .txt one will be considered.

NO – The instrument will keep working with the World.asf (world airspace file – Provided by Flymaster) and

the loaded Open Air one, at same time.

## Flymaster Instrument Manager Software



**Automatic firmware update** - After launching the "Flymaster Instrument Manager" application and if your instrument is connected to your computer's USB port, it may be possible that there is a new firmware version available for your instrument. If you want to update, just answer "start update" and the process will be automatic. Your instrument will restart, and a progress bar will appear on the colour screen with the indication "installing firmware".

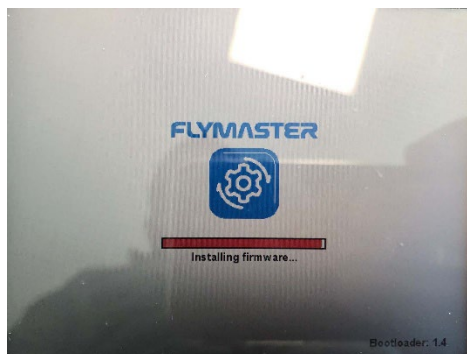

## Main Screen and tools



- 1 – Previous Page
- 2 – Page name (click to edit. [Can be visible in a data field](#))
- 3 – Connection state and info
- 4 – Next Page
- 5 – Copy Airspace file to instrument (open Air)
- 6 – Upload Waypoints file
- 7 – Current tool
- 8 - Pages Layouts
- 9 - Update firmware tool
- 10 – Settings
- 11 – Maps tool (maps management)

## **Copy Airspaces File to instrument (Open Air)**

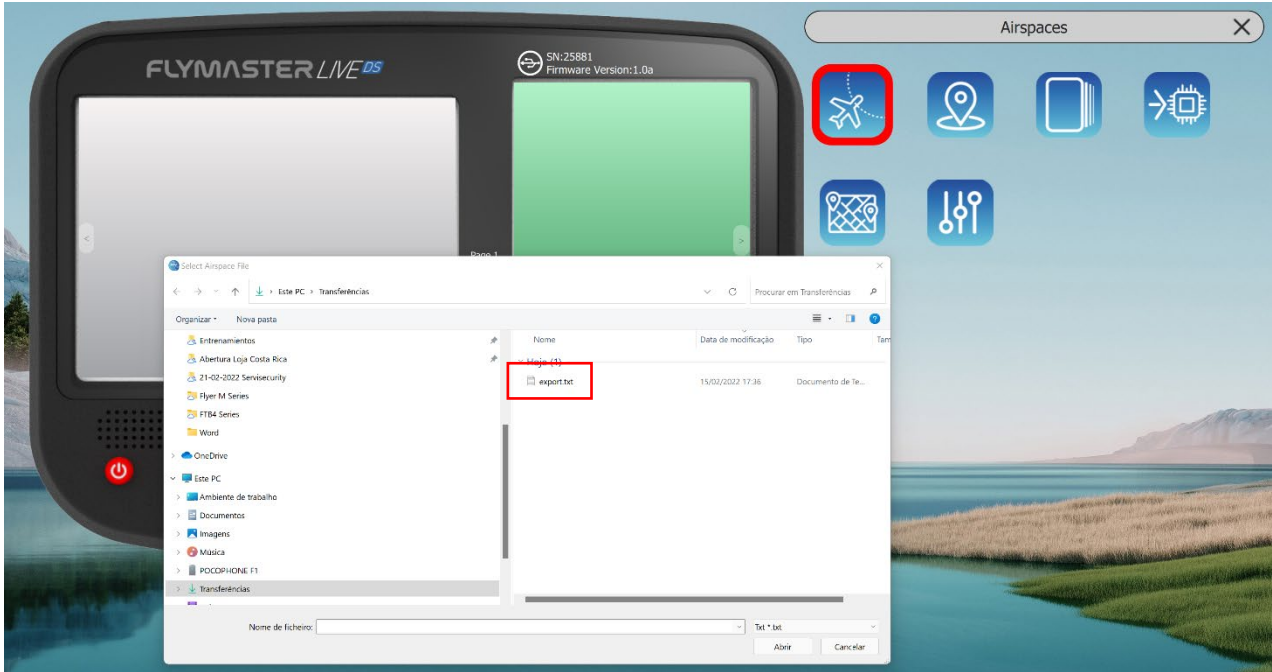

Here you can copy any Open Air file (txt) into the instrument (SD card).  
Later you can use it to activate it (load to memory) using the Airspace Settings.

## Copy Waypoints File to instrument (Open Air)

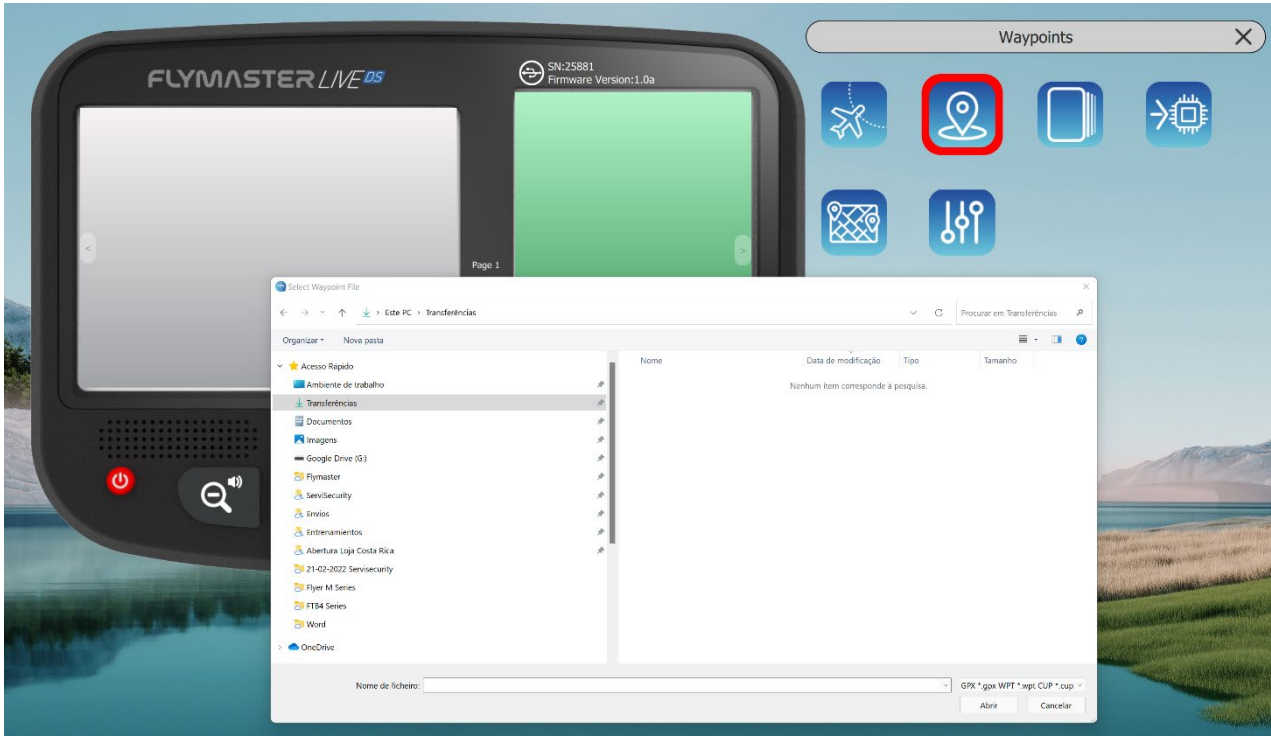

Here you can copy any waypoints file (GPX, WPT,CUP) into the instrument (SD card). Later you can use it to activate it (load to memory) using the Waypoints settings.

## Pages Layouts data fields and objects



- 1 – New pages layout
- 2 – Open pages layout
- 3 – Save pages layout as a file
- 4 – Import pages layout from instrument
- 5 – Send pages layout to instrument
- 6 – Page Triggers (auto page switching behaviour)
- 7 – Back to main F.I.M. page
- 8 – Cut Side view object
- 9 – Vario object
- 10 – Wind arrow object
- 11- Map object (configurable layers)
- 12 – GSM status object
- 13 – Flarm Aware radar object
- 14 – GPS Status object
- 15 – Volume indicator object
- 16 – Compass
- 17 - battery indicator
- 18 – Navigation wheel
- [19 – Data field](#)

## Customizing datafields and objects



After dragging a data field or double click it will show the customization pop-up window of it.

It's possible to change :

- The datafield (data you want to see)
  - The title colour and font size
    - The title background
    - The border colour
  - The datafield font and color
  - The data field background

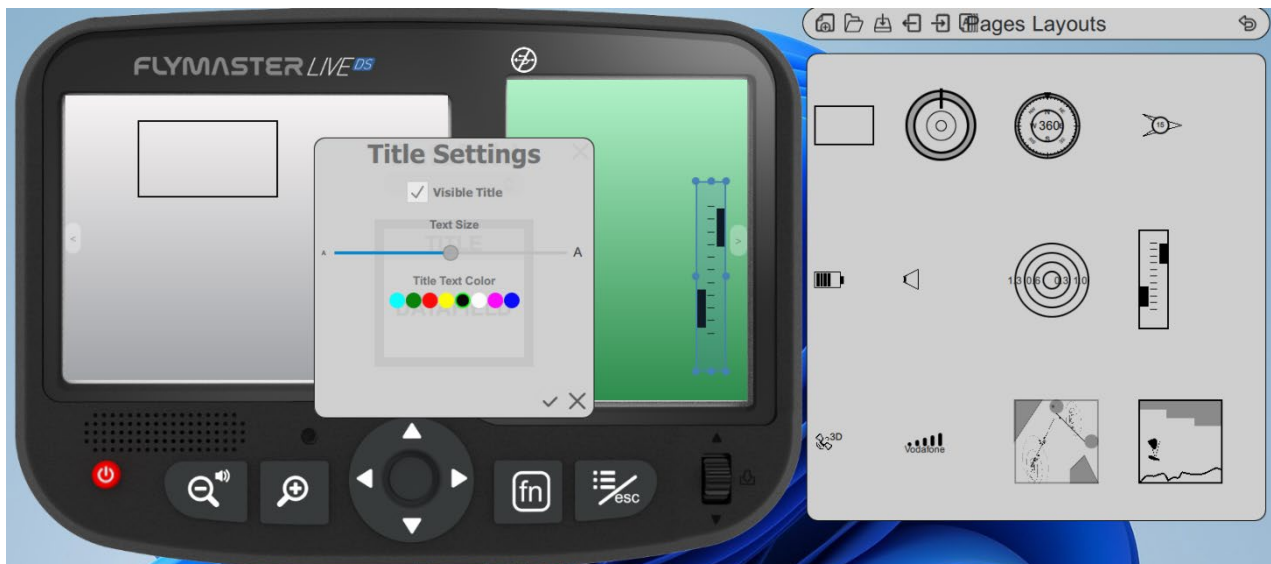



## Page Triggers

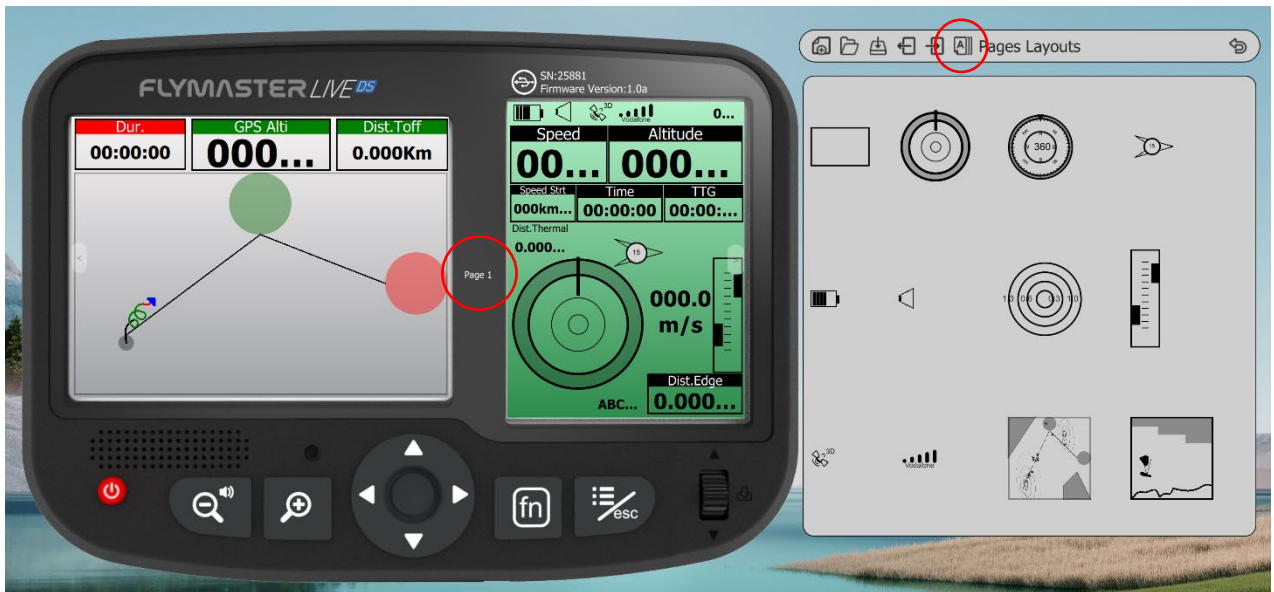

After you design or open a page layout you can configure the page trigger for each page. The page trigger is an auto page switching when the instrument “understands” the pilot position of behaviour. When that behaviour is achieved the page is automatically called.

- 1 – Create or open a Layout
- 2 – Click on “triggers” tool



## Manual firmware update

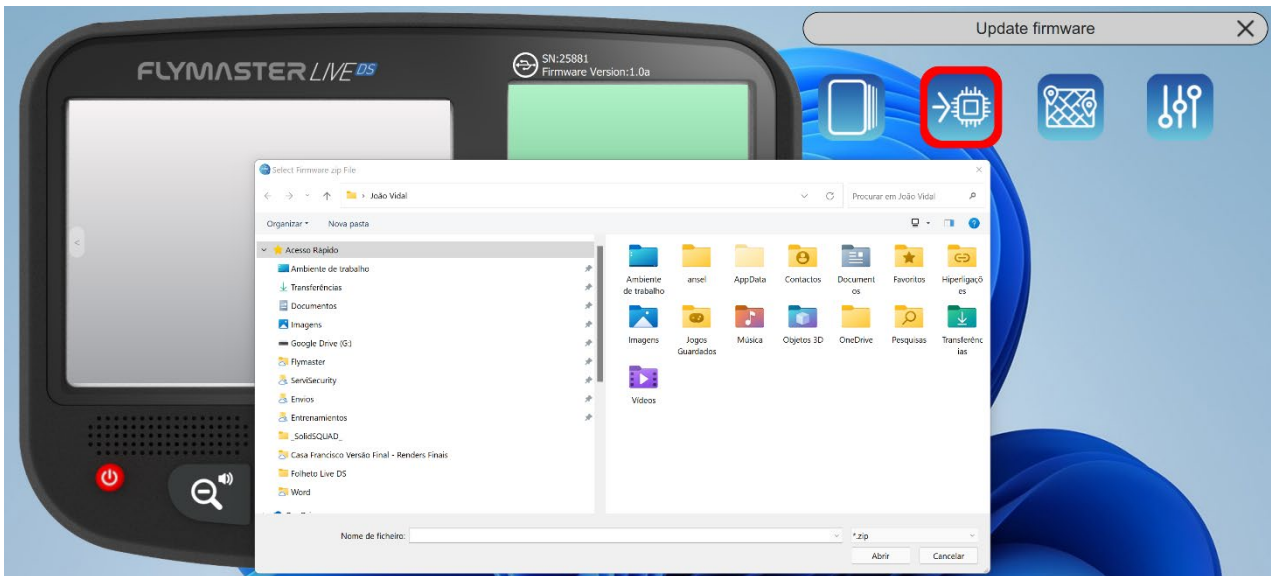

In this tool you can force manual firmware update. Just download the firmware package file, from the Flymaster website and save it to your hard drive. Then just point your location and the process will proceed normally.

## Maps management

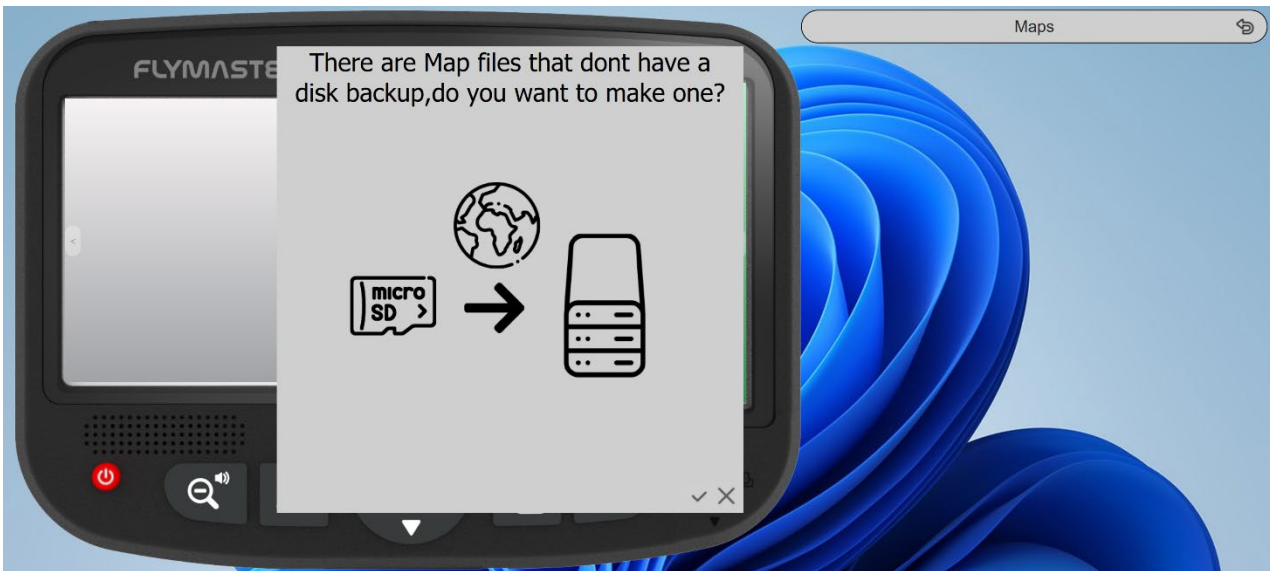

When selecting the "maps" tool, the F.I.M. will give you instructions to eject the micro SD card from your instrument, and insert it into your SD card reader/writer. After this phase and if there are maps on your card that are not stored on your computer, F.I.M. will ask if you want to make a backup of them. **It is convenient to proceed using the check, and make the backup, because in the future, if you want to use the same maps, you no longer need to download them.**

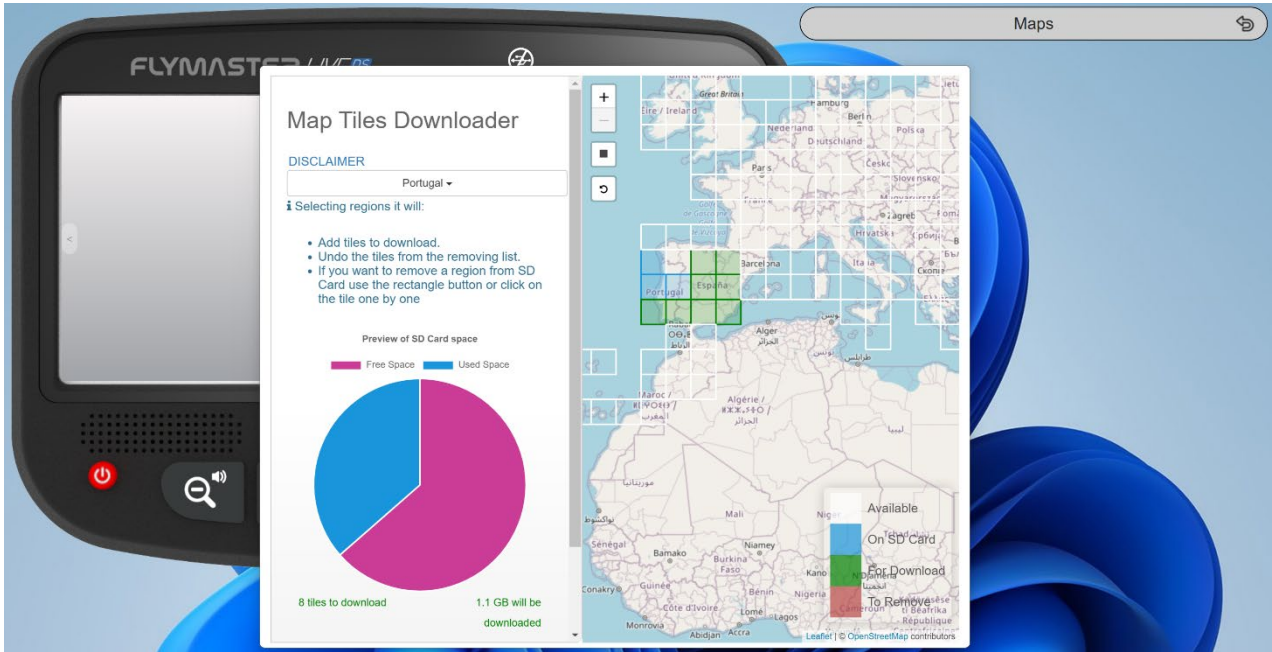

After the backup phase is finished, the SD card and Maps management window will appear. You can click on the available "tiles", you can add tiles, remove them, or check which ones you actually want to download. It is also possible to select automatically by regions.

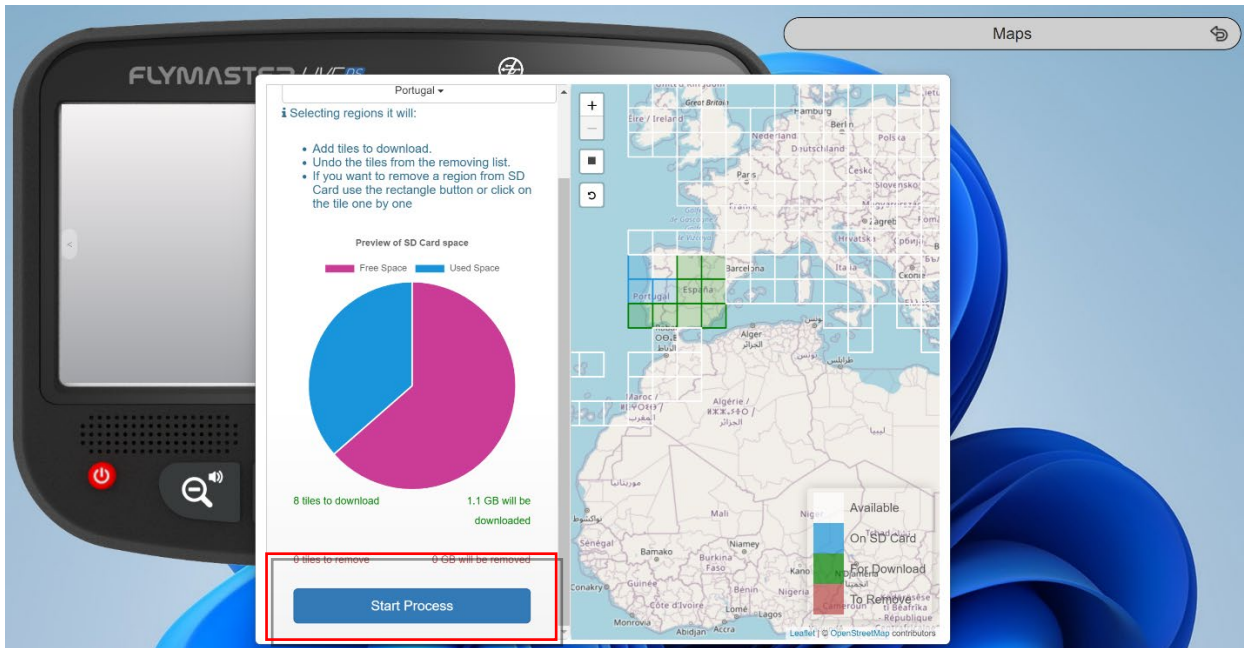

After clicking on "start process", the entire sequence of copying and managing the maps is automatic. At the end of the process, you receive a message saying that you are ready to eject the card and insert into LIVE DS.



## Settings and instrument info



In this tool it is possible to see information about the instrument such as:

**IMEI**

**CCID**

### **Status of the FLARM AWARE licence**

Is also possible to use this page to activate the Flarm Aware licence.

## **Updates and changes**